

ALL IN 1: Laser Deposition Welding & Milling

# Additive Manufacturing in Milling quality

LASERTEC 65 3D

Additive Manufacturing

Laser Deposition Welding & Milling

LASERTEC integration in DMG MORI machines

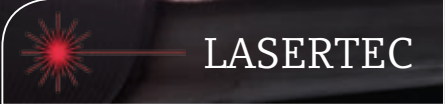
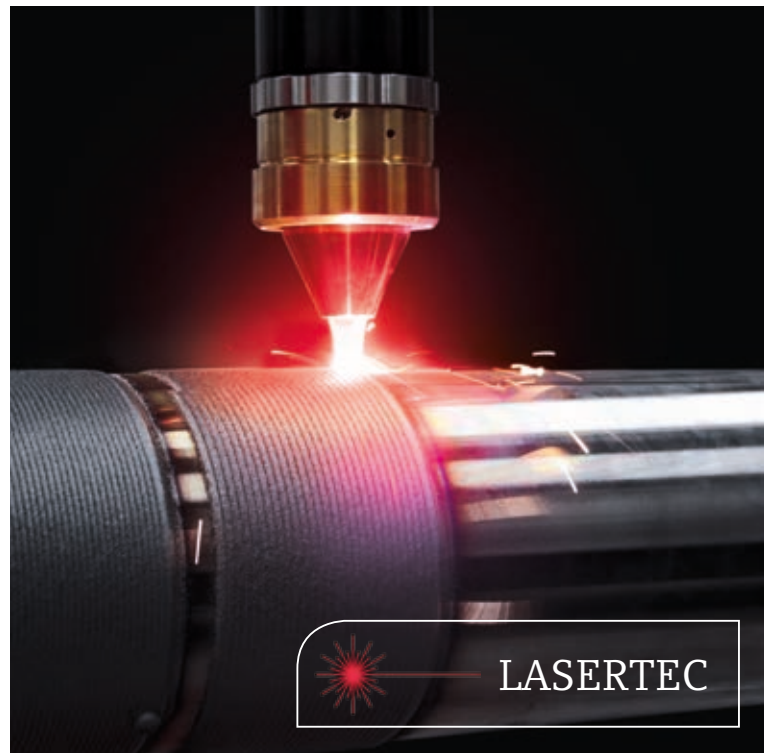
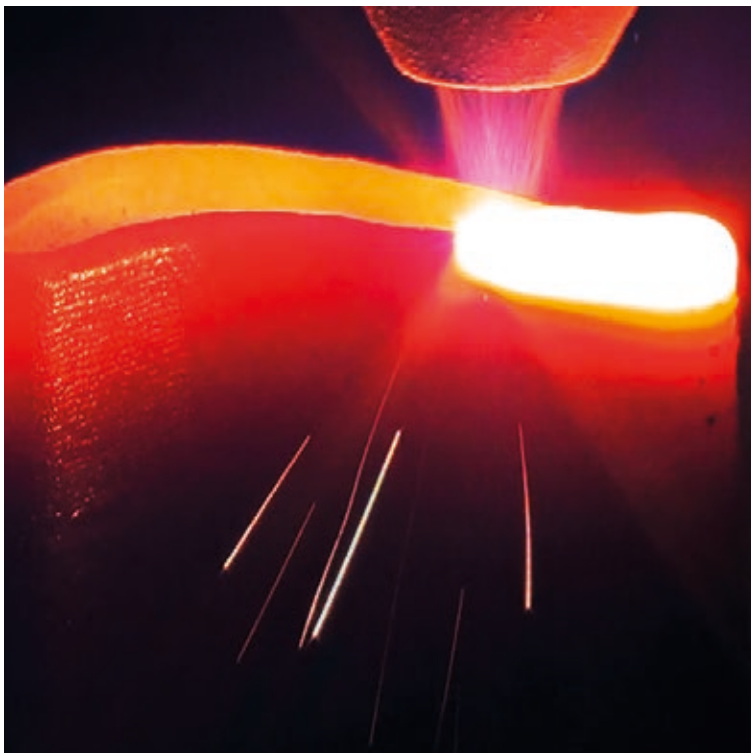

LASERTEC 65 3D: Generation of 3D-parts in Milling quality

## ALL IN 1: Laser Deposition Welding and Milling.

For the first time, DMG MORI has integrated additive manufacturing with lasers into a fully fledged 5-axis milling machine. This intelligent hybrid solution combines the flexibility of laser deposition welding with the precision of material removal, thus allowing for the additive manufacturing of full components in finished parts quality with maximum precision.

The procedure involves an application process featuring a metal powder feed which allows for full machining without a processing chamber and which is up to 10 times faster than generation in a powder bed. Additionally, steep contours can be produced with absolutely no supporting structure. The combination of additive manufacturing with material removal on one machine allows for entirely new applications and geometries. Even large components can be produced cost-effectively with this hybrid solution. The flexible switching between laser and milling operations allows for the direct machining of areas that can no longer be reached on the finished part.



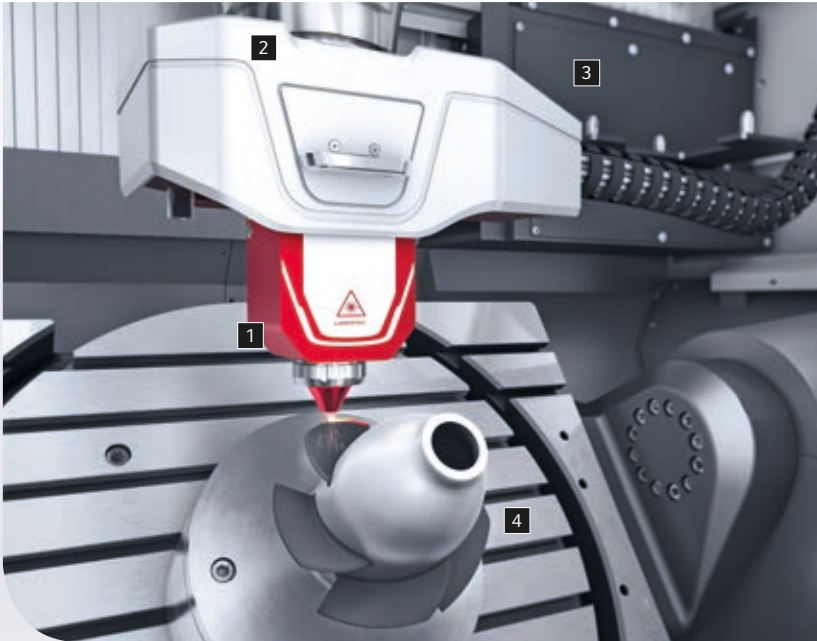

## Machine features

- Laser deposition welding with 2 kW laser diode with powder feed
- Flexible integration of the laser head via the HSK-A63 interface: Combination of laser deposition welding and milling
- The laser head is handled by a fully automatic shuttle
- Integrated NC swivel rotary table for 5-axis simultaneous machining

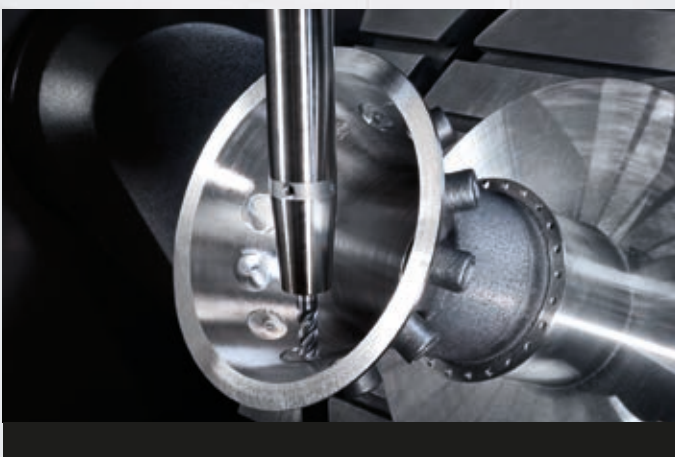

### Highlights LASERTEC 65 3D

- + Fully fledged 5-axis milling machine in the consistently stable monoBLOCK® design with a set-up area\* of less than 12m<sup>2</sup>
- + Fully automatic switching between laser and milling operations with shuttle handling via the HSK interface
- + Large working room for workpieces up to ø 500 mm, 350 mm height and max. 600 kg
- + Ergonomics: 1,430 mm door opening for the best accessibility from in front and above
- + Component design and programming with SIEMENS NX software
- + Monitoring of the application process and online laser output regulation by the integrated optical process monitor
- + CELOS from DMG MORI with 21.5" ERGOline® Control with Operate 4.5 on SIEMENS 840D solutionline

\* Layout of the machine with no aggregates





**Materials:** Stainless steel / Tool steel / bronze alloys / noble metal alloys / nickel-based alloys / chrome alloys / aluminium alloys / chromium molybdenum alloys / tungsten carbide / Stellite

The most important target market segments

# Additive Manufacturing in Milling quality for Production, Repair, Coating.

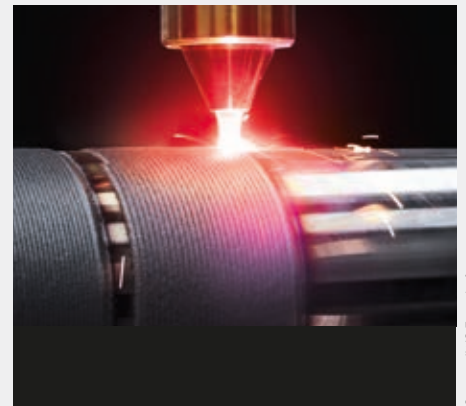
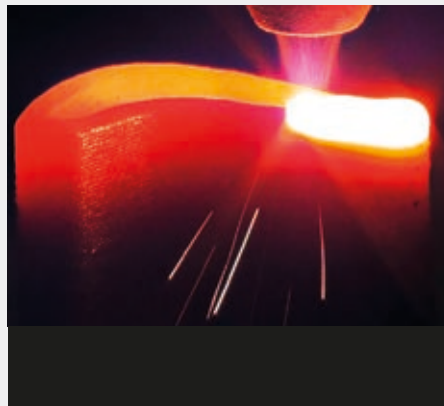
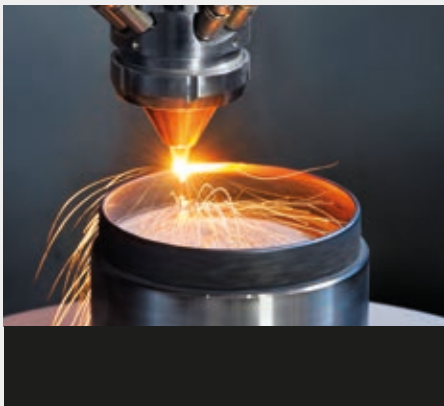

Source: IWS Fraunhofer



Prototypes and small batches of complex lightweight / integral components, e.g. for:

- 1) Tool / mould construction
- 2) Aerospace
- 3) Automotive
- 4) Medical



Repair of damaged and worn components, e.g. for:

- 1) Medical
- 2) Tool / mould construction
- 3) Aerospace (e.g. blade tip repair)



Partial or complete coatings (Corrosion and wear prevention):

- 1) Mould Making
- 2) Off Shore
- 3) Engineering
- 4) Medical

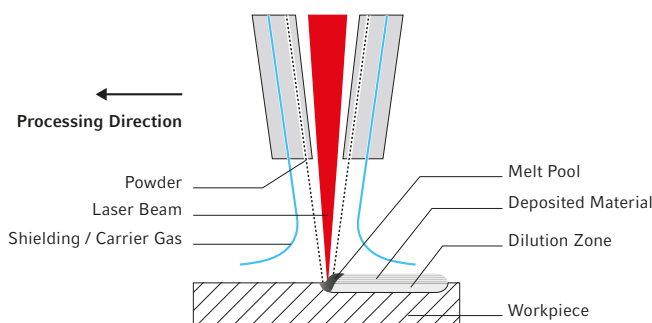

## Working principle – Laser-Deposition-Welding

The metal powder is welded to the basic material in layers (non-porous and crack-free melting). Thereby the metal powder is joining up with the surface in a high strength connection. A coaxial shielding-gas protects against oxidation during the build-up process. After cooling the metal layers can be machined mechanically.



**Turbine housing**  
**Material:** Stainless steel  
**Laser Deposition Welding:** 230 min  
**Milling:** 76 min  
**Dimensions:** 180 mm x 150 mm

## The complete generation of a 3D-part:

### LASER DEPOSITION WELDING



1: Basic set-up of the cylindric ring



2: 90° swivel: Generation of the flange

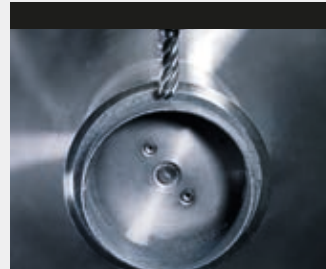

3: 90° swivel: Milling of the plane surface and the outer contour



4: Drilling of the flange

### LASER DEPOSITION WELDING



5: Continuation of the cylinder generation



6: Build-up of the crossover section



7: Laser construction of the conical funnel



8: Generation of the second flange

### LASER DEPOSITION WELDING



9: Manufacturing of the 12 connectors



10: Milling of the connectors



11: Milling of the flange and the inner contour



12: Milling of the inner circular pockets

## LASERTEC 65 3D: Advantages of powder feed over powder bed

- + **10 times faster;** Complete machining without process-chamber (realizable with most materials)
- + **Feasibility of 3D-contours without backing geometry:** e. g. machining of a flange (pic. 2), machining of a cone (pic. 5–7)
- + The flexible **switching between laser and milling operations** allows for the **direct finishing** of component segments that can no longer be reached on the finished part (pic. 3 and 4)
- + **Wall thickness from 0.1 mm to 5 mm possible** (depending on laser and nozzle geometry)



## Programming and machining

- + Entire components can be designed with the SIEMENS NX CAD module
- + **Programming the milling process with NX CAM**
- + Integration of a SAUER module into the NX software for additive manufacturing
- + **The integrated optical process monitor** monitors the application process and regulates the laser output online
- + The workpiece can be **build-up in several steps**. Intermediate milling operations are always possible.
- + It is even possible to produce **full, large components**
- + **3D-geometries** with undercuts realizable

## Laser head switching

- + The laser head is moved laterally into the working area by an **automatic shuttle handling system**
- + The spindle travels to the predefined **change position**
- + The laser head is automatically held in place and integrated by the **HSK-A63 interface** on the spindle
- + After the laser head has been adjusted, the shuttle returns to the change position in the working area
- + During milling operations, the laser head is located outside of the working area in order to protect it against coolant and chips

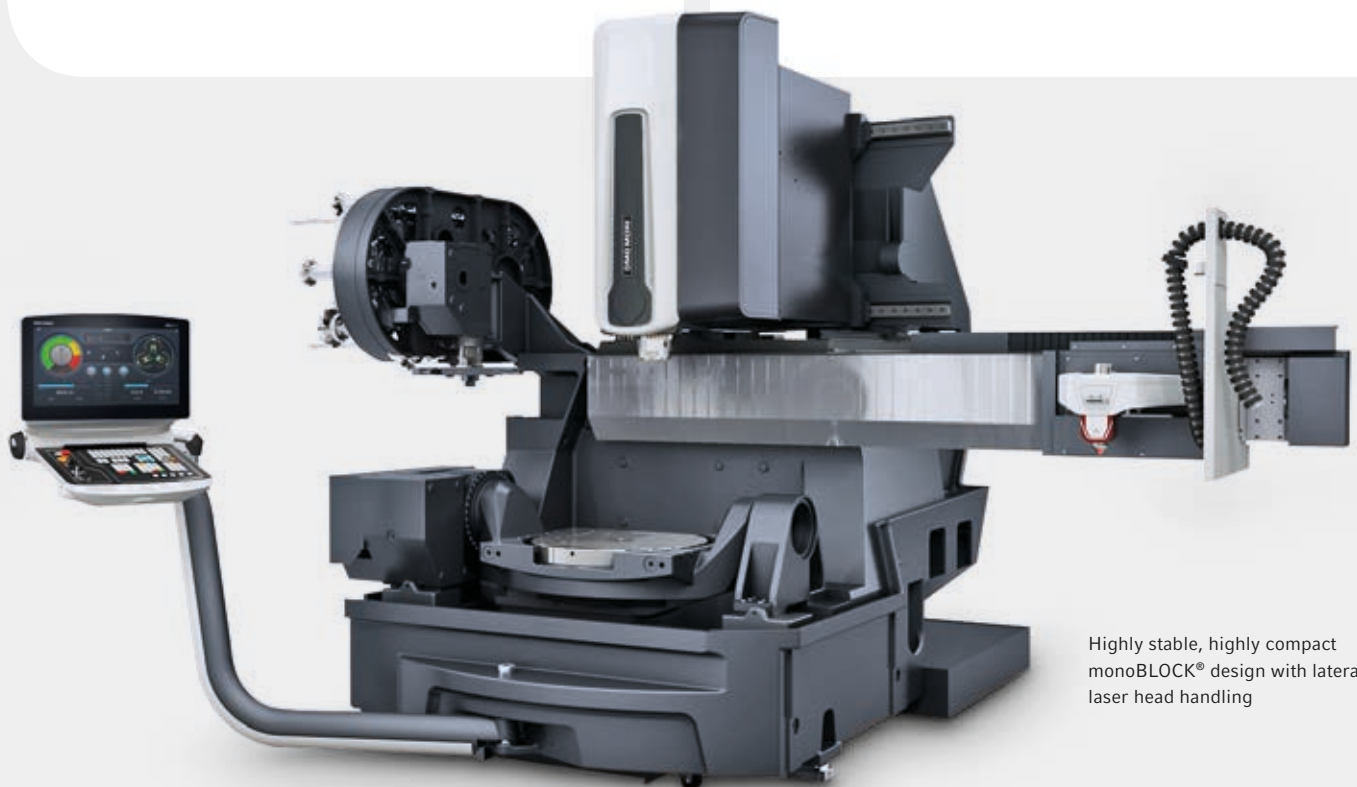

Highly stable, highly compact monoBLOCK® design with lateral laser head handling

# Technical data

## Working area / drives

Traverse X / Y / Z	mm	735 / 650 / 560
--------------------	----	-----------------

## Work table / workpieces

Dimensions (NC swivel rotary table)	mm	ø 650
Maximum workpiece dimensions	mm	ø 500 x 350
Maximum workpiece weight (NC swivel rotary table)	kg	600
Rotary axis (C axis)	Degrees	360
Swivel range (A axis)	Degrees	-120 to +120
P <sub>max</sub> under VDI / DGQ 3441 (C axis / A axis)	Ws	7 / 9

## Milling spindle

Maximum speed (standard / optional)	rpm	10,000 / 14,000
Output 40 % ED / 100 % ED (standard)	kW	13 / 9
Torque	Nm	83 / 57
Tool holder	Type	HSK-A63

## Laser source

Fibre laser diode (standard)	Watt	2,000
Focal length (fixed)	mm	200
Laser spot diameter 1 (standard)	mm	3
Laser spot diameter 2 (optional)	mm	1.6
Deposition rate (varies by material)	kg/h	1.0

## Linear axes (X / Y / Z)

Rapid traverse speed	mm	40 / 40 / 40
Maximum acceleration on X / Y / Z	m/sec <sup>2</sup>	6 / 6 / 6
P <sub>max</sub> under VDI / DGQ 3441	mm	0.008

## Tool change system

Standard / optional tools	Number	30 / 60 / 90
---------------------------	--------	--------------

## Machine data

Width x depth x height (basic machine)	mm	4,180 x 3,487 x 2,884
Machine weight	kg	11,300

## Control system

CELOS from DMG MORI with 21.5" ERGOline® Control with Operate 4.5 on SIEMENS 840D solutionline

# Layout plans

## LASERTEC 65 3D

Front view

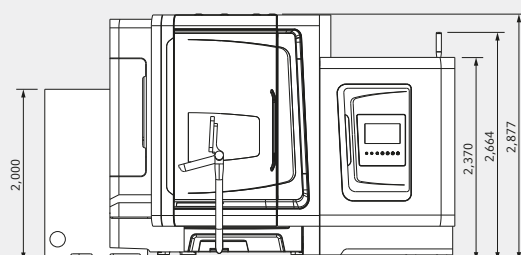

Top view

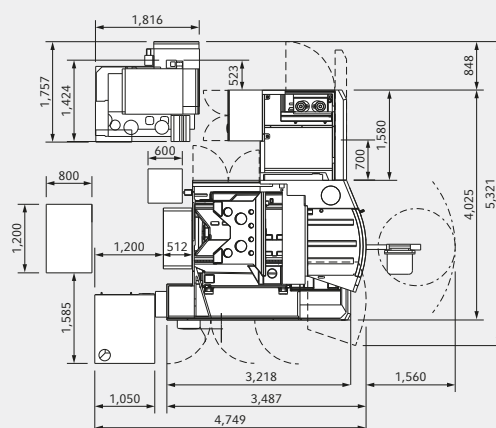



# Unique hybride solution with USP's.

## Highly dynamic machine

- + Full 5-axis milling machine in stable monoBLOCK®-design
- + Large working room for workpieces up to ø 500 mm, 350 mm height and max. 600 kg
- + Doorway 1,430 mm, optimal accessibility from the front
- + Set-up area of less than 12 m<sup>2</sup> (machine layout with no aggregates)

## 3D-Laser Deposition Welding

- + Automatic laser head switching via shuttle handling
- + Integration of the laser head via HSK-interface into the spindle
- + Laser source: 2 kW diode laser in the standard
- + Automatic change between laser and milling machining

## 5-Axis-Milling

- + Possibility of milling between the alternating laser build-up process
- + Best possible surface qualities and part accuracies
- + Manufacturing of parts in milling quality

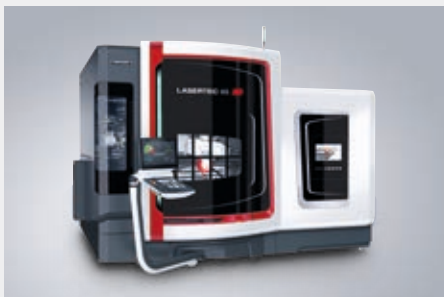

## Exhibition performance in 2014/15:

- 08.09. – 13.09.2014: **IMTS**, Chicago
- 16.09. – 20.09.2014: **AMB**, Stuttgart
- 30.10. – 04.11.2014: **JIMTOF**, Tokyo
- 25.11. – 28.11.2014: **EUROMOLD**, Frankfurt
- 03.02. – 07.02.2015: **DMG MORI SEIKI OPEN HOUSE**, Pfronten
- 20.04. – 25.04.2015: **CIMT**, Beijing

### DMG MORI SEIKI Europe AG

Lagerstrasse 14, CH-8600 Dübendorf

Tel.: +41 (0) 44 / 8 01 12 - 40, Fax: +41 (0) 44 / 8 01 12 - 31

info@dmgmori.com, www.dmgmori.com

# DMG MORI