

---

LASERTEC Additive Manufacturing

---

LASERTEC Shape

---

LASERTEC PrecisionTool

---

LASERTEC FineCutting

---

LASERTEC PowerDrill

Progress Through Innovation

# LASERTEC Series



LASERTEC

Progress Through Innovation

## The next generation of 3D laser machining.

LASERTEC unlocks new economic opportunities for laser precision machining of technical surface structures, intricate cavities, fine engravings, inscriptions and holes with a wide variety of high-tech materials and diamond tools. As an absolute global first, with its intelligent combination of laser deposition welding and 5-axis milling, LASERTEC presents a way to produce entire 3D components in finished parts quality through additive manufacturing.

The LASERTEC product line focuses on five technological fields: Additive Manufacturing, Shape, PrecisionTool, FineCutting and PowerDrill. Depending on the application and component requirements, a range of laser sources such as YAG, fibre and picosecond lasers can be used. User-specific software packages make it easier to work and program in the various fields of application.



### Flexible LASERTEC technology integration in 5-axis milling machines from DMG MORI.

By using a special device, a laser scanning head can be substituted into the milling machine. It can be adapted to the milling spindle within minutes via the HSK-interface. This flexible integration of LASERTEC technology allows for 5-axis milling and laser texturing of injection moulds (LASERTEC Shape) or laser deposition welding (LASERTEC Additive Manufacturing\*) in one clamping operation on one machine. This distinguishing feature can easily be integrated into the DMU (C) 65 and 125 monoBLOCK®, as well as the DMU 210 from the portal range of DMG MORI.

\* only available as LASERTEC 65 3D



## LASERTEC Additive Manufacturing

Combination of laser deposition welding and 5-axis milling for the additive manufacturing of entire 3D components in milling quality. Can also be used to repair and coat components from, for example, the mould construction and aerospace sectors.

**Technology Highlights: Pages 08–13**

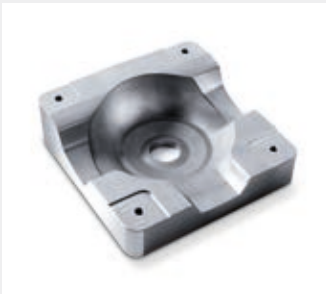

## LASERTEC Shape

Laser structuring of geometrically defined surfaces in plastic injection tools for mould making. 3D laser ablation for filigree cavities, engravings and inscriptions.

**Technology Highlights: Pages 14–29**

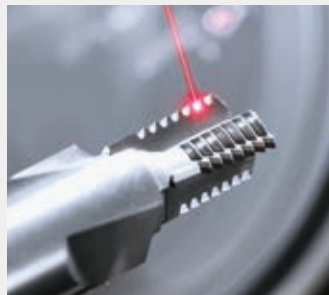

## LASERTEC PrecisionTool

Cutting edges, clearance angles and chip breakers in PCD, CVD-D precision tools. Cut out of inserts made of PCD and CBN. Carbide extrusion dies for indexable inserts as well as prototypes.

**Technology Highlights: Pages 30–39**

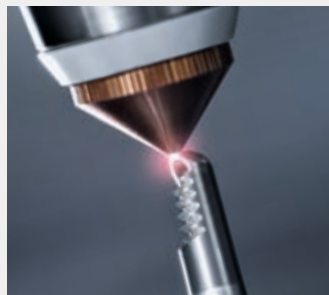

## LASERTEC FineCutting

Highly dynamic 2D / 3D laser precision cutting of sheets, tubes and 3D parts. Production of components for the watch / medical industry and stamping part components.

**Technology Highlights: Pages 40–41**



## LASERTEC PowerDrill

High-precision 5-axis laser drilling of cooling holes in turbine components for aircraft engines and industrial gas turbines.

**Technology Highlights: Pages 42–49**

LASERTEC Series

# The right machine platform for every laser application.

From a filigree embossing tool for the watch industry to a dashboard for cars, from small helicopter turbine blades to the combustor for large industrial gas turbines – LASERTEC has the right machine platform for every application.

Depending on the integrated laser source and programming software, the basic machines are utilised for the different laser technologies. In the LASERTEC 65 / 125 / 210 models the surface structuring and additive manufacturing laser technology is integrated into a fully fledged milling centre via the HSK interface, allowing for full machining (milling and laser texturing/cladding) on one machine.

LASERTEC 20 PrecisionTool  
LASERTEC 20 FineCutting



LASERTEC 45 Shape

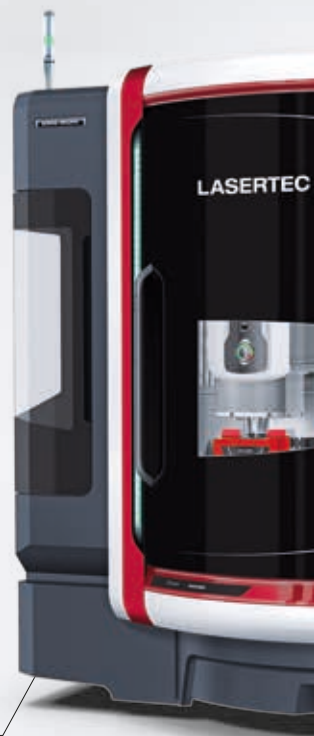

LASERTEC 65 Shape  
LASERTEC 125 Shape



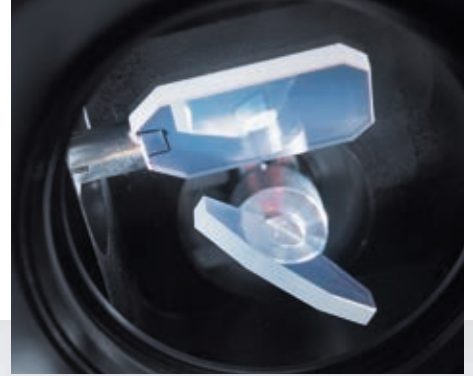
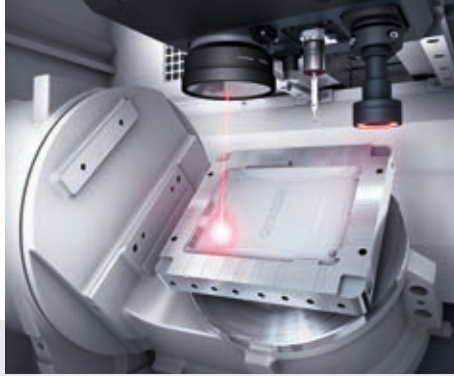

## Highest Stability / Long-term Stability

All LASERTEC Series machines are based on a highly stable cast frame construction. The combination of precision construction and a direct positioning measuring system ensure long-term stability and accuracy.

## 5-axis Machine Version

All machines are available as a 5-axis version for laser machining of complex component geometries on one machine. Depending on the series, various 5-axis kinematics are employed.

## Precision

The latest generation of scanners combined with tailored precision optics for maximum precision and shortened machining times.

LASERTEC 80 PowerDrill

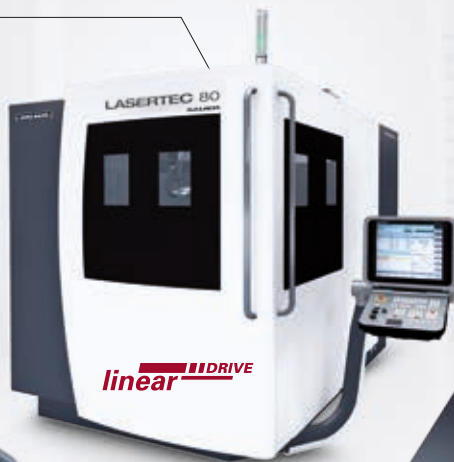

LASERTEC 65 3D

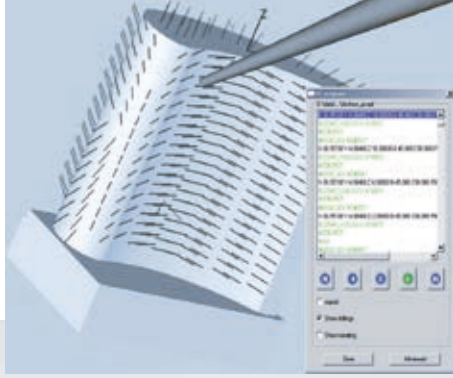

## Powerful Control

Uniform control philosophy with Siemens 840D solutionline Operate 4.5 3D continuous path control. From 2015 the LASERTEC 20 / 65 / 125 / 210 are also available with CELOS including 21,5" ERGOline® Control with multi-touch screen.

## LASERSOFT Software Packages

Application-specific software packages facilitate the programming and operation of the machine. Customised programming systems allow easy creation of machine programmes based on CAD data. Complex processes can be depicted graphically in advance using simulation tools.

## Flexible Technology Integration

Integration of a laser scanning head via the HSK 63 / 100 interface: A unique global selling point thanks to the intelligent combination 5-axis milling and laser texturing and cladding technology on one machine.

LASERTEC 130 PowerDrill



linear **DRIVE**

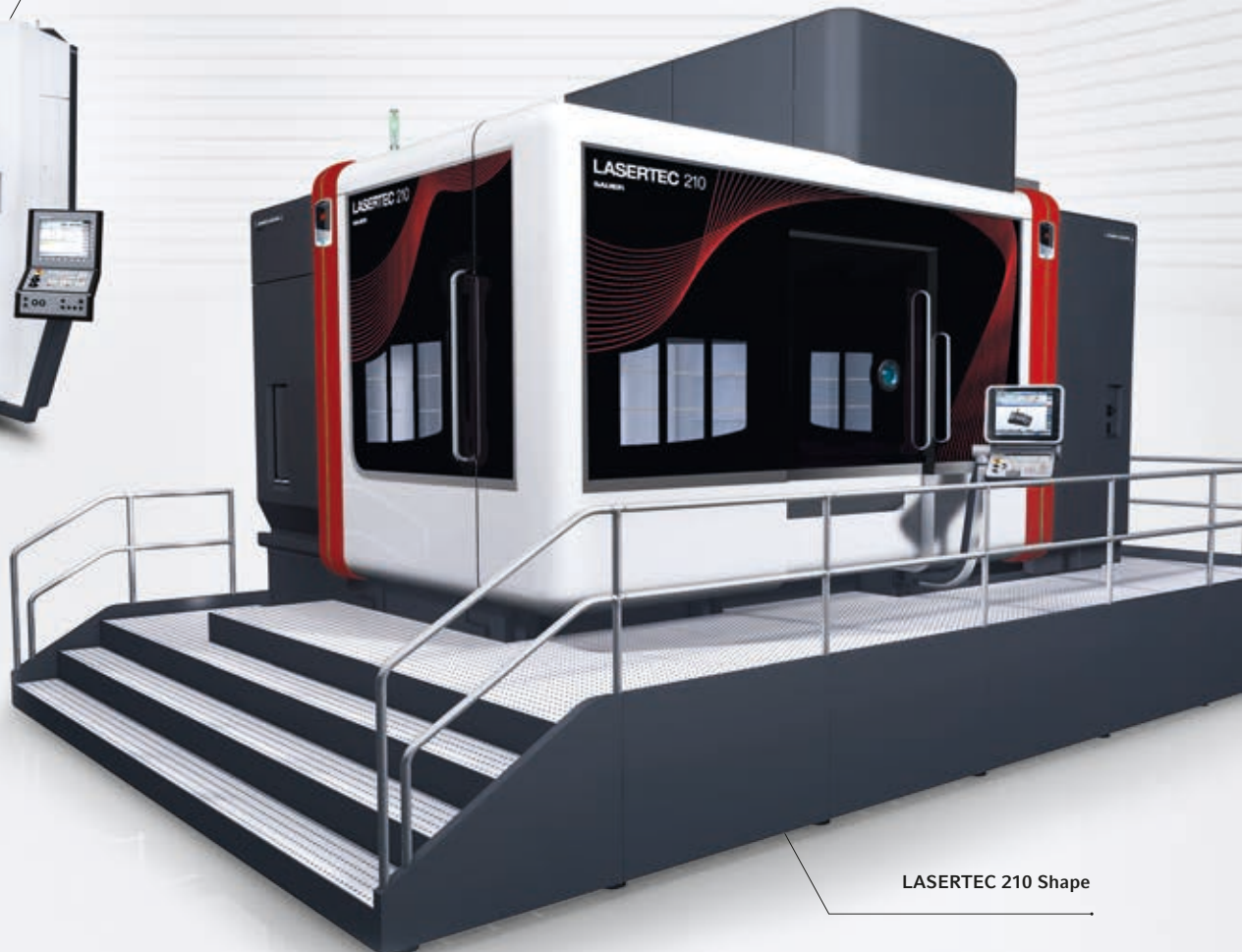

LASERTEC 210 Shape



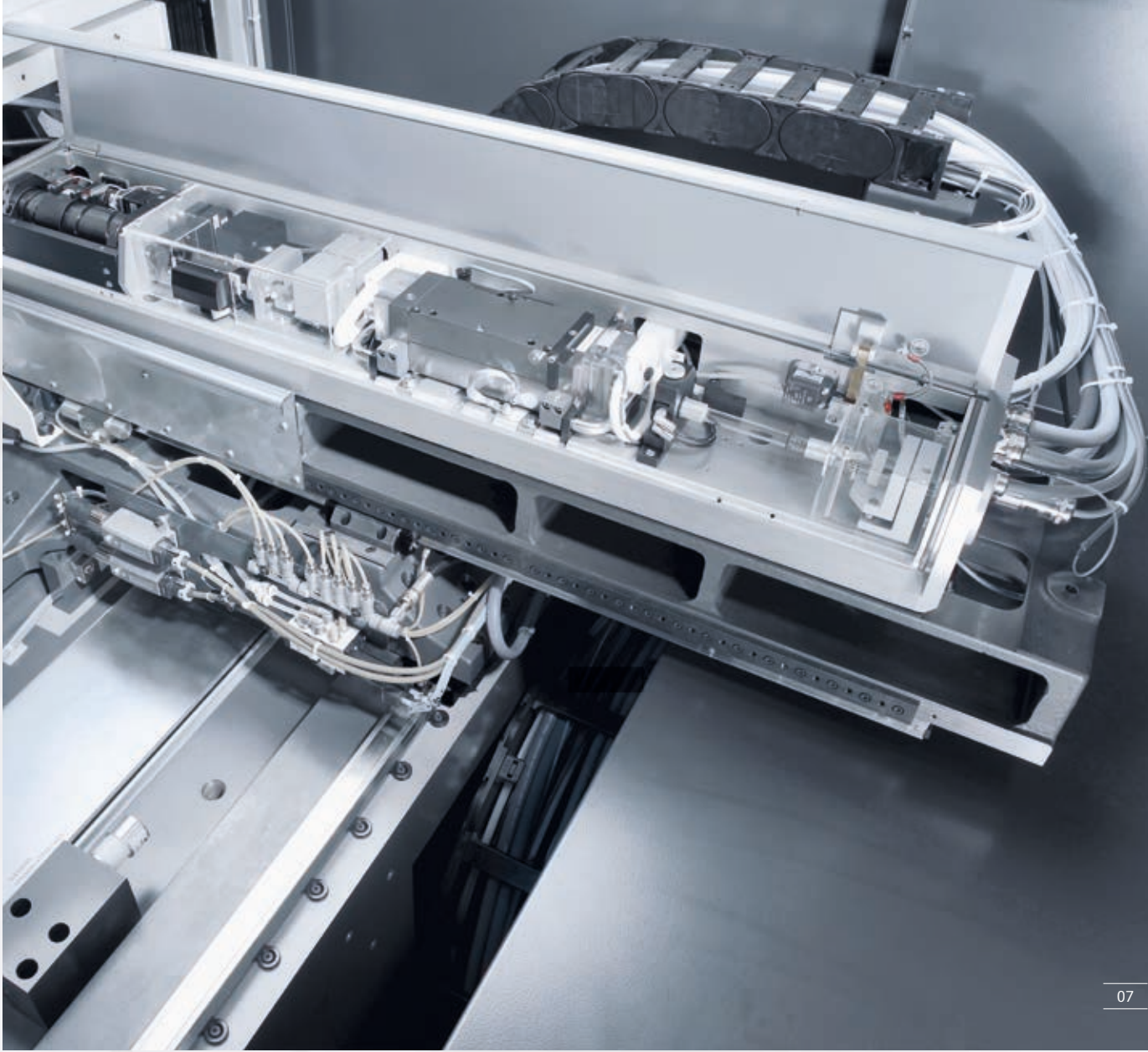

Application-specific laser sources available.

	Shape		FineCutting		Precision-Tool	PowerDrill		Additive Manufacturing
	Q-Switch / Fibre	Pico-second	CW Fibre	QCW Fibre	Fibre	Nd:YAG	QCW Faser	Laser diode
LASERTEC 20			300 W	1.5–9 kW	100 W			
LASERTEC 45	20 W 100 W		300 W	1.5–9 kW				
LASERTEC 50		25 W 50 W				300 W 500 W	3–18 kW	
LASERTEC 80						300 W 500 W	3–18 kW	
LASERTEC 130						300 W 500 W	3–18 kW	
LASERTEC 65 / 125 / 210	50 W 100 W 200 W							2 kW*

\* only LASERTEC 65 3D

Laser  
deposition  
welding  
and milling





# ALL IN 1: Laser Deposition Welding and Milling.

Additive manufacturing unlocks new opportunities for high complexity and individuality in the production of prototypes and functional components made of high-performance metallic materials. The additive manufacturing market is growing steadily. For the first time, SAUER LASERTEC has integrated additive manufacturing with lasers into a fully fledged 5-axis milling machine. To date, this innovative hybrid solution is unique on the global market. The process uses an application process featuring a metal powder feed which is up to 10 times faster than generation in a powder bed.

In the past, additive manufacturing was limited to the production of prototypes and small parts. The combination of additive manufacturing with a powder feed and material removal processes on a machine allows for entirely new applications and geometries. Especially large components, which still have an extremely high material removal rate, can be produced cost-effectively thanks to this innovation.

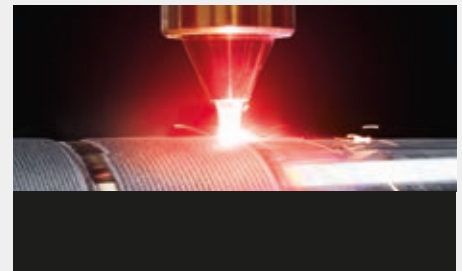
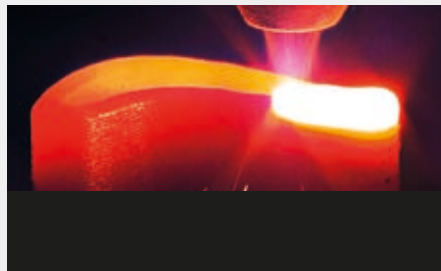
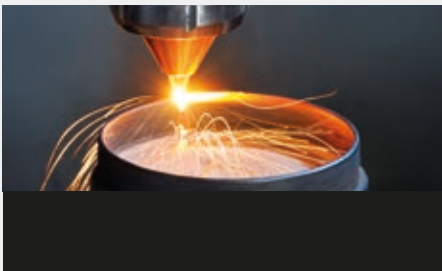

Source: IWS Fraunhofer



Prototypes and small batches of complex lightweight / integral components:

- + Tool / mould construction
- + Aerospace
- + Automotive
- + Medical



Repair of damaged and worn components, e. g. for:

- + Medical
- + Tool / mould construction
- + Aerospace (e. g. blade tip repair)



Partial or complete coatings (Corrosion and wear prevention):

- + Mould Making
- + Off Shore
- + Engineering
- + Medical

**Turbine housing**  
**Material:** Stainless steel  
**Laser Deposition Welding:** 230 min  
**Milling:** 76 min  
**Dimensions:** 180 mm × 150 mm



LASERTEC Additive Manufacturing

# Additive Manufacturing in Milling quality – the complete generation of a 3D-part.

LASER DEPOSITION WELDING



MILLING



10

1: Basic set-up of the cylindric ring

2: 90° swivel: Generation of the flange

3: 90° swivel: Milling of the plane surface and the outer contour

4: Drilling of the flange

LASER DEPOSITION WELDING



5: Continuation of the cylinder generation

6: Build-up of the crossover section

7: Laser construction of the conical funnel

8: Generation of the second flange

LASER DEPOSITION WELDING

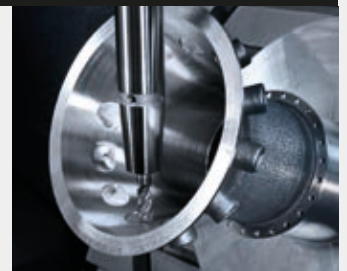

9: Manufacturing of the 12 connectors

10: Milling of the connectors

11: Milling of the flange and the inner contour

12: Milling of the inner circular pockets



## Machining

- + Entire components can be designed with the SIEMENS NX CAD module
- + **Programming the milling process with NX CAM**
- + Integration of a SAUER module into the NX software for additive manufacturing
- + **The integrated optical process monitor** monitors the application process and regulates the laser output online
- + The workpiece can be **build-up in several steps**. Intermediate milling operations are always possible.
- + It is even possible to produce **full, large components**
- + **3D-geometries** with undercuts realizable

## Laser head switching

- + The laser head is moved laterally into the working area by an **automatic shuttle handling system**
- + The spindle travels to the predefined **change position**
- + The laser head is automatically held in place and integrated by the **HSK-A63 interface** on the spindle
- + After the laser head has been adjusted, the shuttle returns to the change position in the working area
- + During milling operations, the laser head is located outside of the working area in order to protect it against coolant and chips

## Materials

- + Stainless steel
- + Tool steel
- + Aluminium alloys
- + Cobalt-chrome-molybdenum alloys
- + Bronze alloys
- + Noble metal alloys
- + Nickel-based alloys
- + Tungsten carbide
- + Stellite

## Working principle – Laser-Deposition-Welding

The metal powder is welded to the basic material in layers (non-porous and crack-free melting). Thereby the metal powder is joining up with the surface in a high strength connection. A coaxial shielding-gas protects against oxidation during the build-up process. After cooling the metal layers can be machined mechanically.

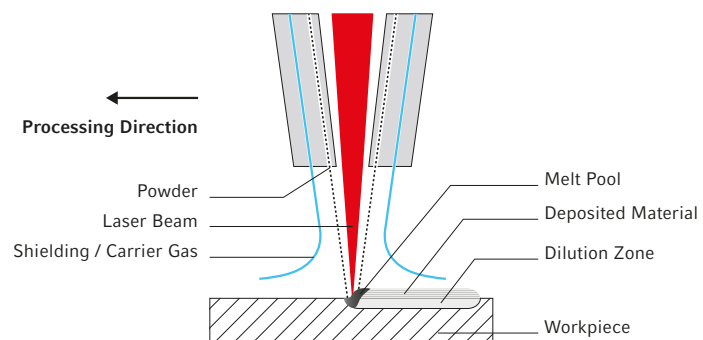



LASERTEC 65 3D

# Additive Manufacturing in Milling quality.

For the first time, DMG MORI has integrated additive manufacturing with lasers into a fully fledged 5-axis milling machine. This intelligent hybrid solution combines the flexibility of additive manufacturing with the precision of material removal, thus allowing for the additive manufacturing of full components in milling quality.

The procedure involves an application process featuring a metal powder feed which allows for full machining without a processing chamber and which is up to 10 times faster than generation in a powder bed. Additionally, steep contours can be produced with absolutely no supporting structure. The combination of additive manufacturing with material removal on one machine allows for entirely new applications and geometries. In particular, large components can be produced cost-effectively with this hybrid solution. The flexible switching between laser and milling operations allows for the direct machining of segments that can no longer be reached on the finished part.



## Highlights

- + The intelligent combination of laser cladding and milling allows for the best surface finishes and component precision
- + Laser deposition welding with powder feed: 10 times faster than the powder bed; steep contours with no supporting geometry
- + It is even possible to produce full components
- + Realisation of 3D geometries with undercuts
- + Direct machining of areas that can no longer be reached on the finished part

1: The laser head is moved laterally into the working area by an automatic shuttle handling system; integration of the laser head via the standardised HSK interface on the spindle; laser deposition welding of an impeller with powder feed



		Additive Manufacturing
<b>Available as</b>		
<b>Working area</b>		
Traverse X / Y / Z	mm	650 / 650 / 560
Maximum workpiece size	mm	ø 500 × 350
Maximum workpiece weight (NC swivel rotary table)	kg	600
Rotary axis (C axis)	°	360
Swivel range (A axis)	°	-120 to +120
<b>Milling spindle</b>		
Speed (standard)	min <sup>-1</sup>	10,000
Torque 40 % ED / 100 % ED (standard)	kW	13 / 9
Tool holder	Type	HSK-A63
<b>Laser source</b>		
Fibre laser diode (standard)	Watt	2,000
Deposition rate	kg/h	1
<b>Linear axes (X / Y / Z)</b>		
Rapid traverse speed	mm	40 / 40 / 40
Maximum acceleration on X / Y / Z	m/sec <sup>2</sup>	6 / 6 / 6
P <sub>max</sub> under VDI / DGQ 3441	mm	0.008
<b>Machine data</b>		
Width × depth × height	mm	4,180 × 3,487 × 2,884
Machine weight	kg	11,300
<b>Control system</b>		
21,5" ERGOline® Control		Siemens 840D solutionline Operate 4.5 with CELOS

## 3D Laser Ablation

1: Fine contours and filigree cavities



14

## 5-axis Laser Texturing

2: Design advantage for injection mould making

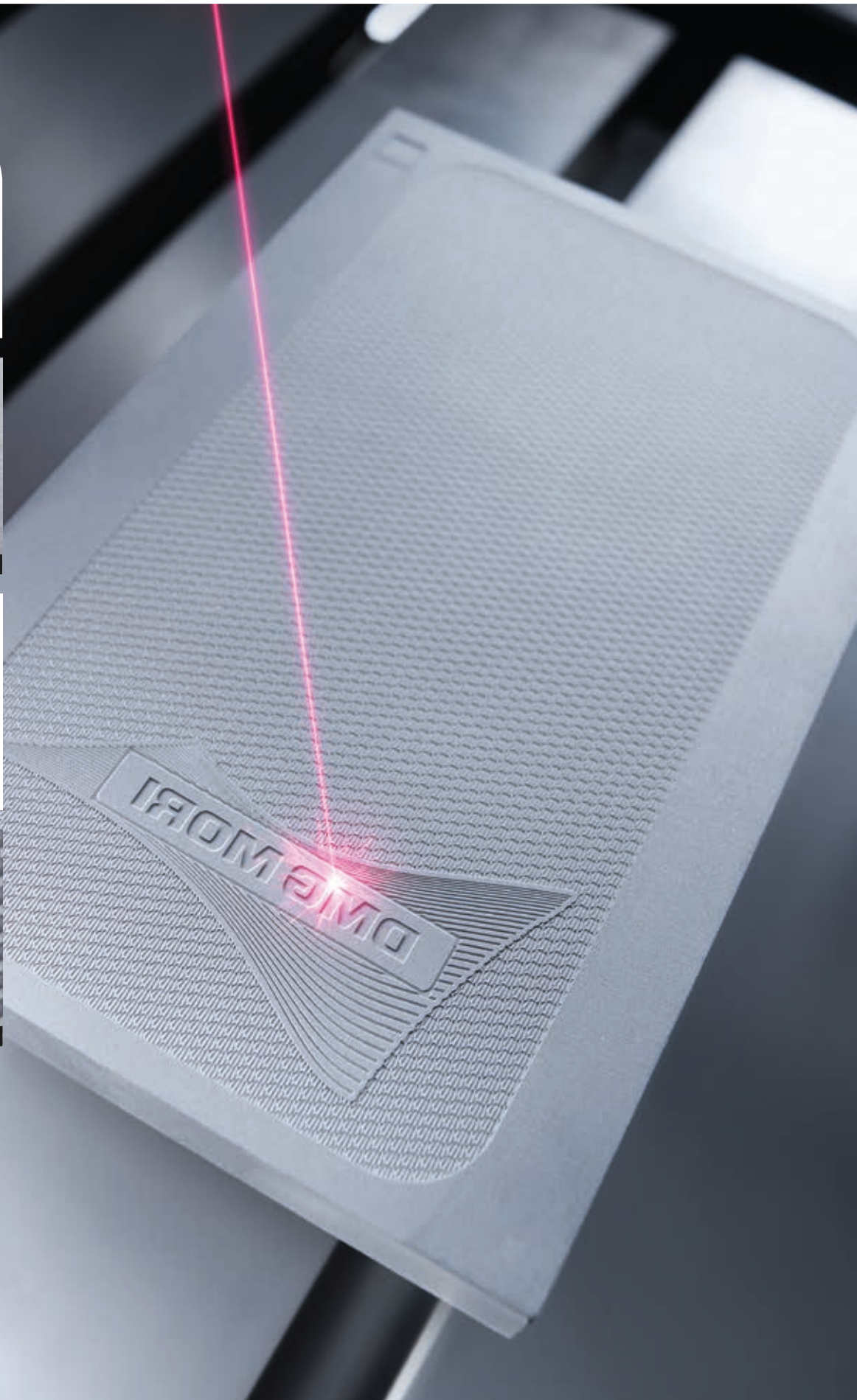
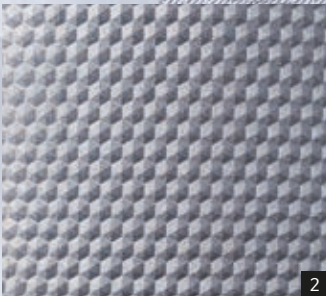





- 1: Manufacture of technical mould components made of carbide
- 2: The finest contours in stamping and forming tools, forming dies
- 3: Engravings / Inscriptions
- 4: Steering wheel cap with a honey-comb structure
- 5: Textures on PC and mobile phone casings

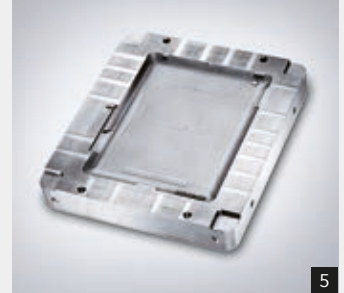
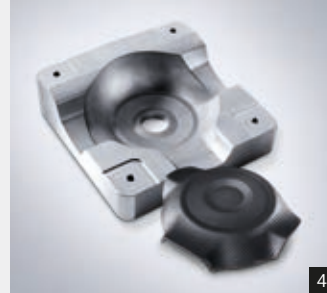

LASERTEC Shape

# LASERTEC Shape: Filigree surface texturing, 3D ablation, laser engraving.

With the LASERTEC Shape Series, fine contours and filigree cavities for injection moulds, extrusion dies, inscriptions and other engravings can be consistently and reliably produced with the highest quality and minimal tool wear. Depending on the application, there are machine configurations with three laser sources featuring different ablation characteristics available: diode, fibre, and picosecond lasers. Depending on the material and laser source, walls up to max. 2 mm deep and surface quality of  $Ra < 0.3 \mu m$  is possible.

The machine programme itself can be generated automatically from the 3D CAD data of the actual work piece. The optionally available LASERSOFT software packages simplify e.g. contour generation, lettering, logos and surface structuring in 3D surfaces, cylinders or free-form surfaces.

LASERTEC Shape working principle

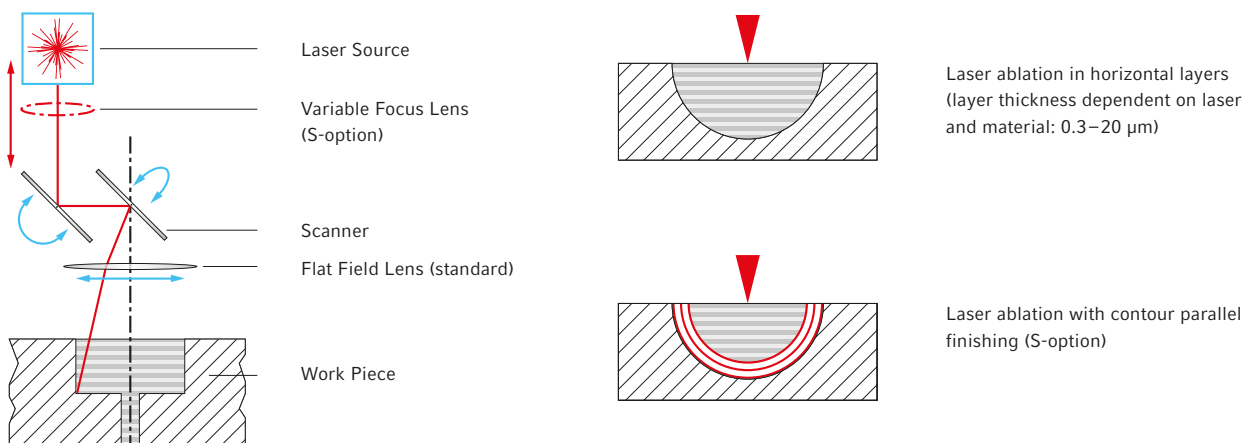

3D Laser Ablation

# 3D laser ablation for the production of miniature moulds, extrusion dies, inscriptions and engravings.

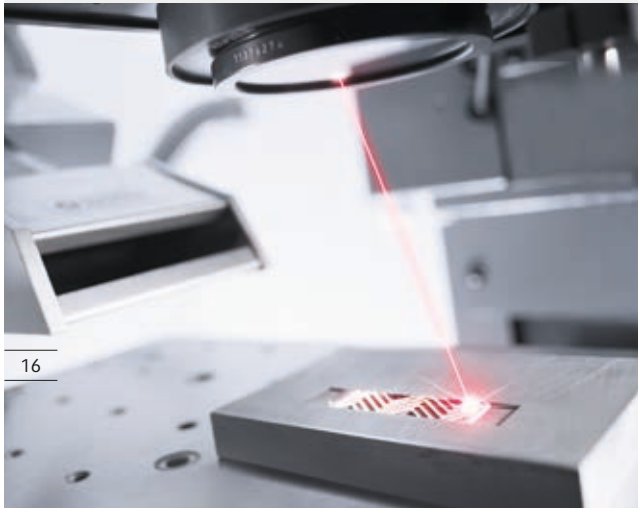

Highlights / 3D Laser Ablation

- + **Flexible for many applications:** Engravings and inscriptions, coins and medals, extrusion dies, technical miniature moulds, injection moulds for the toy industry
- + **Laser machining of standard materials** as well as advanced materials, including **glass, ceramics and carbide**
- + **Feasibility of steep walls** of the highest quality, with the highest process reliability (depending on the material)
- + **Easy and fast importing of CAD data**

## LASERSOFT 3D-Softwarefeatures

3D Draft Angle with Defined Wall Angles

Starting with 2D CAD data in DXF format, the programme will take into account the desired depth and draft angle to automatically generate the programme for the laser machine. This means easy creation of engravings, logos, symbols, simple tools, etc.



3D Bitmap Generator

Based on greyscale images in bitmap format, different grey levels can be assigned to different depths. This allows 3D reliefs, surface structures, logos, etc. to be produced, even when using a basic scanned document. It is also possible to reduce data volume by converting STL data into bitmap data.





### 3D Cylinder Machining

This feature allows you to edit cylinder and cone geometries, which can be combined as required with a rotary axis.



### 3D Free Surface Projection

Vertical projection of the geometry to be machined on slightly inclined free-form surfaces. The machining geometry is extended depending on the angle of inclination of the projection surface.



### Laser Marking

Inscriptions directly from the LASERSOFT 3D control software. You can select the text, font, gradient and other text attributes.



### Job Creator

This software feature allows the placement of several different work pieces on the machine table (using the carrier system / pallet) as well as manual setup of the work pieces with the aid of a camera.



### Auto Video Setup

Automatic calibration of clamped components incl. calculated correction (displacement or rotation) of the corresponding component programmes. The built-in CCD camera finds predefined measurement points to make automatic position corrections.



Laser Texturing

# Design advantage for injection mould making. The most important target markets.

The time of simple leather structure interiors for cars is as outdated as the mass-produced textures for many consumer goods. The innovative 5-axis laser texturing makes it possible to quickly produce individual surface textures in plastic injection moulds. The design possibilities for challenging visual surfaces are now unlimited.

Highlights

- + Realisation of individual, challenging 3D textures with free-form surfaces made from injection moulds
- + The high machine precision makes excellent contour sharpness and consistency possible via laser machining
- + Contour parallel laser shaping: Laser focus follows the 3D contour of the work piece
- + Laser lacquer removal with a track width of 40 µm possible
- + Highly dynamic, temperature monitored precision scanner
- + Fibre laser with up to 200 Watts;  
Additional options: various focal lengths



## Automotive

- (1) **Steering Wheel Cap:** Honeycomb structure
- (2) **Motor Cover:** Pyramid structure
- (3) **Tire Side Wall:** Carbon fibre structure
- (4) **Glove Compartment Door:** Combination of honeycomb / leather structure
- (5) **Connecting Rods:** Cell structure



1

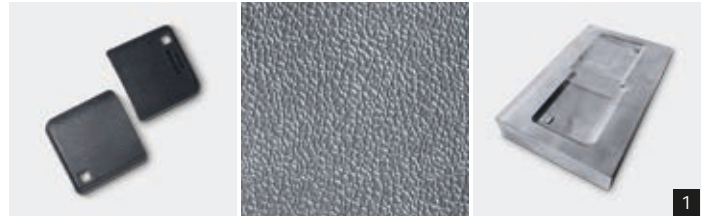

1

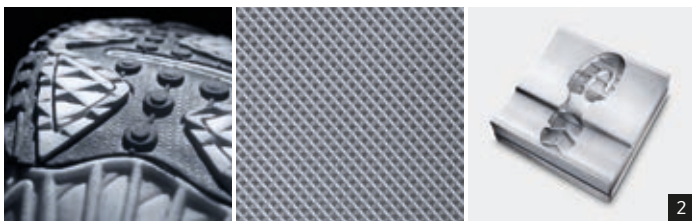

2

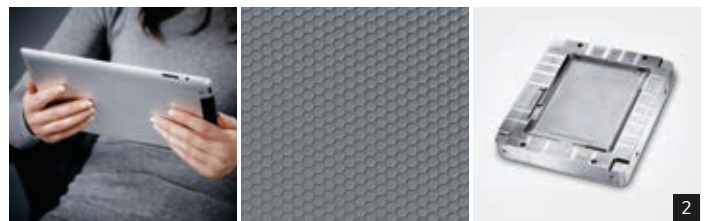

2

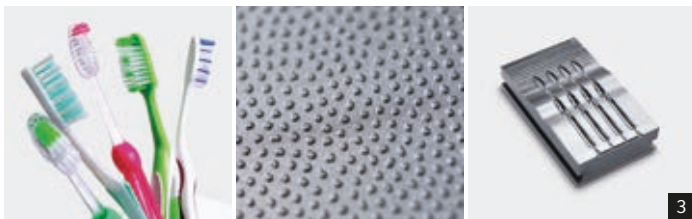

3



3



4

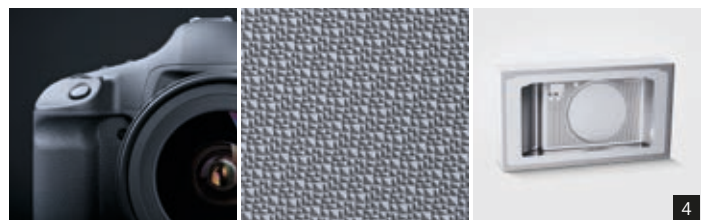

4



5

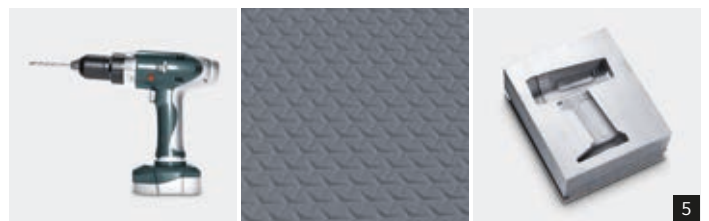

5

## Additional Mould Making

- (1) **Blow Moulds, PET Bottles:** Nub structure
- (2) **Shoe Sole:** Scale structure
- (3) **Wellness and Cosmetics, Tooth Brushes:**  
Nub structure
- (4) **Food Industry:** 3D engravings
- (5) **Plastic Chair:** Wood grain

## Consumer Electronics

- (1) **Mobile Phone Case:** Leather structure
- (2) **Back Cover for Tablet PC:** Honeycomb structure
- (3) **PC Mouse:** Pelt structure
- (4) **Camera Housing:** Ribbing
- (5) **Electric Drill Housing:** Triangle / star structure

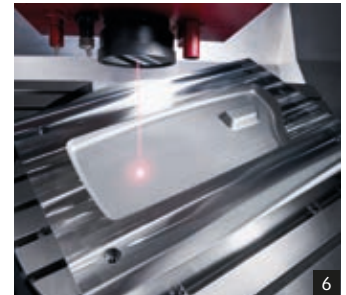
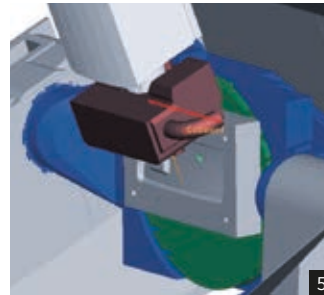
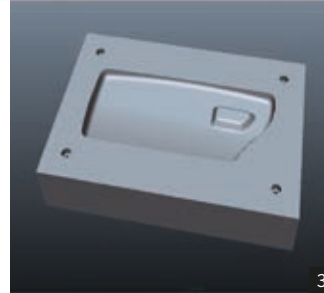
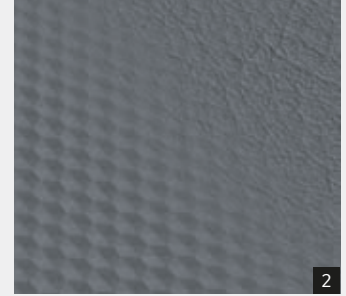
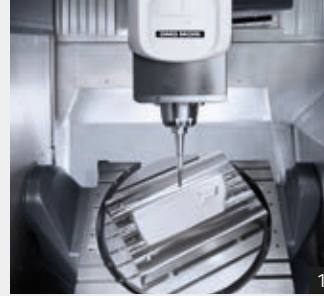

## The Comprehensive, Digital Process Chain

- Milling the mould
- Honeycomb and leather structure with transition
- IGES of the 3D tool mould
- Uniform transfer of the texture to the mould
- 3D simulation of the CNC machining programme
- 5-axis laser texturing of the surface structure
- Finished structured injection mould
- Finished plastic injection moulded part

### Laser Texturing

The comprehensive, digital process chain – from the idea to the final, structured injection-mould piece.

The all-encompassing LASERSOFT 3D-TEXTURE guides the user from the setup of the greyscale bitmap through to the finished, textured component. The projection of the texture on free-form surfaces is implemented via standardised software tools. The 5-axis laser-machining programme is generated completely automatically. Transitionless “patching” of even large visible surfaces and the contour-parallel lasering on complex 3D free-form surfaces opens unlimited possibilities for the design and implementation of individual repeatable surface structures.



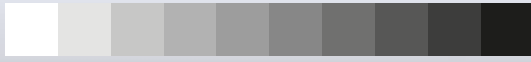

The darker the colour, the deeper the ablation.



### Easy operation with Bitmaps / 3 easy routes to a personalised texture

1. Create the texture with a CAD programme
2. Create the texture with a graphics programme e. g. Photoshop, Gimp etc.
3. Scan a real 3D object e. g. via GOM 3D scanner



### “Variable patch field sizes” with no visible separation lines

Crucial for the quality of the mapped surface structure is the lowest possible distortion of the image on the three-dimensional contour. The individual tiles (structure fields) must be placed together so that no dividing lines and impacts are visible. The intelligent “Variable Patch Field Sizes” software aids this process.

### “Contour-parallel laser shaping” for quick process execution on complex forms

Depending on the 3D contour of the work piece, the laser focus can be dynamically shifted to the Z-axis via a Z-shift. You no longer have to reposition the laser head or the work piece on the Z-axis for every new lasering trace, saving you significant time.

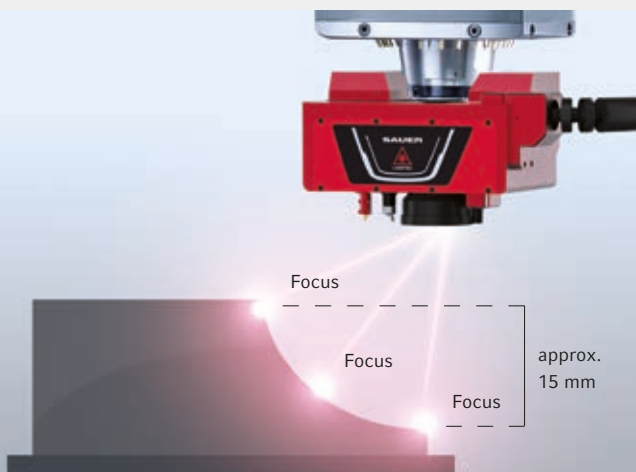

### Central supply with texturing information for identical results around the world

The comprehensive, digital process chain makes it possible to generate centrally unified texturing data, which in turn can be distributed to subsidiaries, licensees and structured partners worldwide. This allows the same component to be manufactured with the same texture worldwide.



LASERTEC 45 Shape

## High-precision 3D laser removal and texturing in a new dimension.

As the successor to the LASERTEC 40, the new LASERTEC 45 boasts the highest diversity, a completely new operating concept, a larger work table, longer traverses, higher workpiece weights and fully integrated 5-axis machine kinematics.

The new user-friendly control interface allows for simple operation by touch screen, direct programming into the control system and offline programming for more complex components.

Whilst providing maximum process reliability and reproducibility, the new LASERTEC 45 can generate geometrically defined surface structures, the finest contours and delicate cavities for the production of injection moulds, extrusion dies, inscriptions and engravings of the highest quality in 2D and 3D forms and with no tool wear.



### Highlights

- + Highly compact 5-axis machine concept with a large working area measuring 700 × 380 mm
- + Higher deposition rates thanks to the re-adjusted precision scanner system
- + 5-axis laser machining made possible by the integrated swivel/rotary axis with torque motors (optional)
- + 80 % larger working area with the same space requirements plus 3 times higher dynamics with 60 m/min rapid traverse (compared to the LASERTEC 40)
- + The new, user-friendly user interface allows for intuitive programming via the touch screen
- + Operate 4.5 on SIEMENS 840D solutionline with 15" touch screen



- 1: Working area image with integrated NC swivel rotary table (optional), precision scanner optics, measuring sensor for depth regulation, CCD camera for X/Y orientation with ring light
- 2: Maximum precision with the inherently stiff and low-vibration column
- 3: 5-axis version – Fully integrated NC swivel rotary table (A axis  $-100^{\circ}$  to  $+120^{\circ}$  / 100 kg)
- 4: Also available in a 3-axis version with rigid table (840 x 420 mm / 400 kg)

Available as		Shape
<b>Working area</b>		
X axis	mm	700
Y axis	mm	420
Z axis (focusing axis)	mm	485
<b>Work table / workpiece</b>		
Table size (3 axes / 5 axes)	mm	840 x 420 / $\varnothing$ 200
Maximum table load (3 axes / 5 axes)	kg	400 / 100
<b>Miscellaneous</b>		
Maximum acceleration on X / Y / Z	$m/s^2$	10 / 10 / 16
Machine dimensions W / D / H	mm	1,650 x 2,234 x 2,580
Control system		Siemens 840 D solutionline with 15" touch screen



LASERTEC 50 Shape

## 5-axis machining of challenging carbide tools using a picosecond laser.

Thanks to its highly compact, stable design, in combination with the high-performance picosecond laser the LASERTEC 50 is particularly suited to demanding 5-axis machining work involving the production of complex prototypes and special cemented carbide workpieces. This means even surface finishes of  $Ra < 0.3 \mu\text{m}$  can be achieved in cemented carbide tools. The LASERTEC 50 with picosecond laser is available with a 25 W or 50 W laser.

### Highlights

- + Linear drives with acceleration  $> 1\text{g}$
- + Highly dynamic torque motors in both rotary axes (B- and C-axis)
- + High positioning accuracy of  $\leq 8 \mu\text{m}$
- + CCD camera and 3D measuring probe for fast setup
- + Massive, vibration dampening machine bed with 3-point support
- + User-friendly Siemens 840D solutionline CNC control (comes standard)



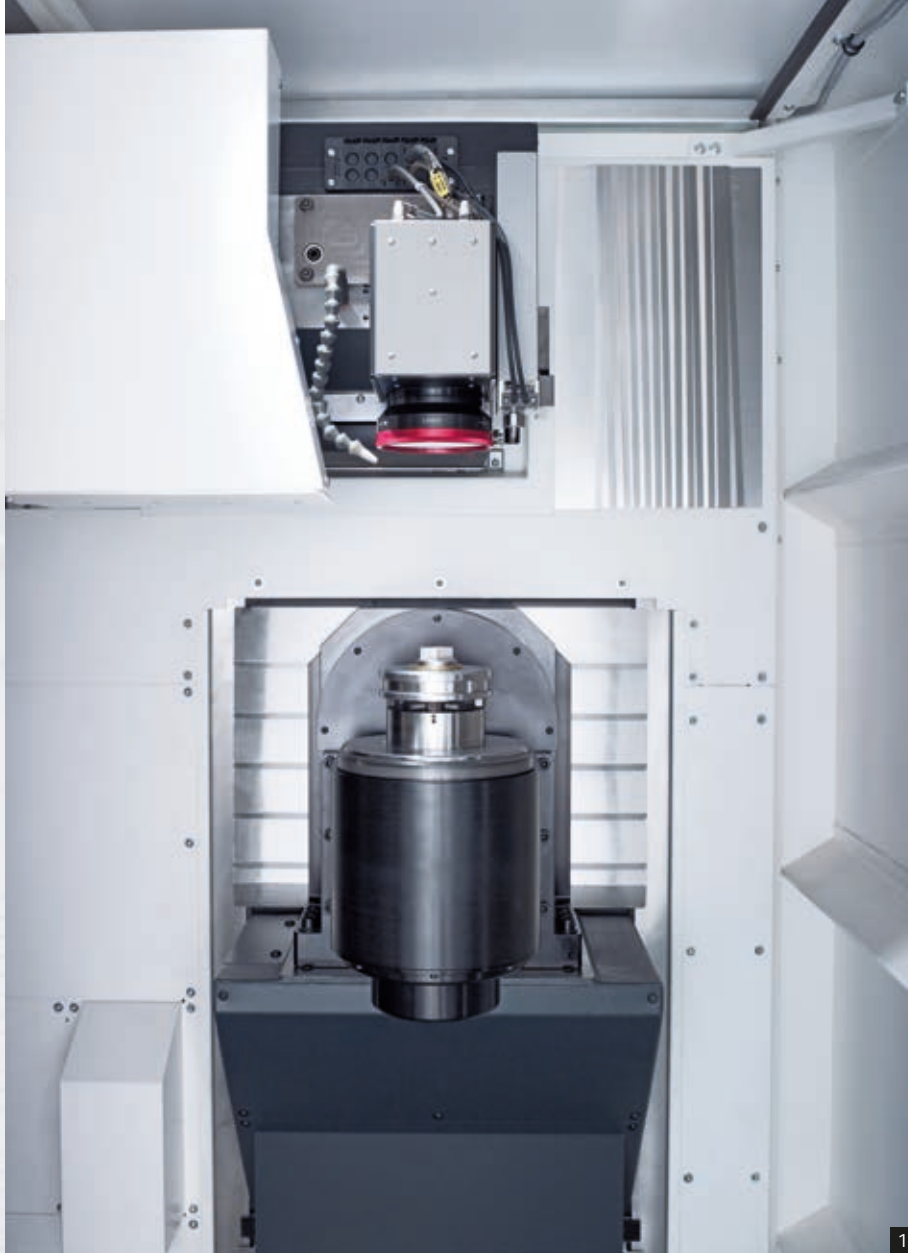

1: Clearly structured working area with optimal workpiece accessibility 2: Massive, consistently stable mineral composite column  
 3: Precision scanner, CCD camera and measuring sensor 4: High-precision laser machining of demanding, complex geometries on up to 5 axes 5: 5-axis laser machining of a cemented carbide tool with a picosecond laser

Available as	
<b>Work Area</b>	
X-axis	mm
Y-axis	mm
Z-axis (focusing axis)	mm
Table size (3 axes)	mm
Max. table load (3 axes)	kg
A- / B-axis (swivel range)	Degrees
C-axis (speed)	Degrees
Table size (5 axes)	mm
Max. table load (5 axes)	kg
<b>Traverse Speed</b>	
Rapid traverse in X / Y / Z	m/min
Acceleration	g
Machine / Unit weight	kg
Footprint W / D / H	mm
<b>Control</b>	
CNC control	

Shape
500
500
700
400 x 500 (Work surface)
150
-100 to +160
360° continuous
ø 200
14
60 / 60 / 30
1
5,000
3,700 / 4,250 / 2,400
Siemens 840D solutionline

LASERTEC 65 Shape

# ALL-IN-1 – 5-axis laser machining and milling in one precision machine.

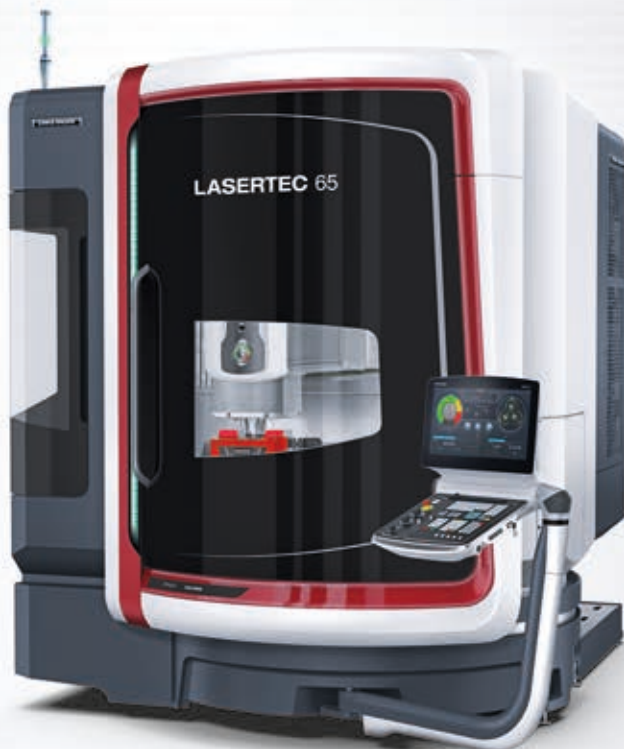

## Highlights

- + MILL + LASER: Fully-fledged 5-axis milling machine from DECKEL MAHO in the stable monoBLOCK® design; flexible integration of a laser head via an HSK interface
- + Conversion from milling to laser operation in < 10 min.
- + Large work area for work pieces up to ø 840 mm, 500 mm high and max. 1,000 kg
- + Crane loading from above over the table centre (comes standard)
- + Accessibility and ergonomics: Door opening is 1,430 mm, optional accessibility from the front
- + Small 7.5 m<sup>2</sup> footprint

The highly dynamic LASERTEC 65 combines, for the first time, all the stability advantages of monoBLOCK® design with the benefits of a quick swivel rotary table and is the most compact machine in its class, with a 7.5 m<sup>2</sup> footprint. Equipped with an optimally accessible, large work area and travels of 650 × 650 × 560 mm (X / Y / Z), it dominates as a highly flexible 5-axis machine for all laser and milling applications with an uncompromisingly high level of quality. For the first time, the LASERTEC 65 Shape offers 5-axis milling and laser structuring of 3D plastic injection mould tools on one machine in a single setup. After the milling of the mould, a geometrically defined surface structure is applied via fibre lasering. Final erosion or etching is not necessary.





1: Large working area with integrated NC swivel rotary table with perfect accessibility, can be loaded from above by crane  
 2: Highly stable, compact monoBLOCK® design 3: Flexible integration of a laser scanning head via an HSK interface on the spindle, 5-axis laser texturing of a steering wheel injection mould



**LASERTEC**  
**65 / 125 Shape**  
 also available purely  
 as a laser machine\*

\* Based on the milling machine configuration for absolute long-term stability and repeat accuracy

		LASERTEC 65 Shape (monoBLOCK®)	LASERTEC 125 Shape (monoBLOCK®)
Travel (X / Y / Z)	mm	650 / 650 / 560	1,250 / 1,250 / 900
Max. work piece dimensions (5-axis)	mm	ø 840 × 500	ø 1,440 × 790
Max. load weight (5-axis)	kg	600 (1,000**)	2,000 (2,600**)
Min. footprint (only machine)	m/m <sup>2</sup>	approx. 7.9	approx. 20
Control	Type	SIEMENS 840D solutionline with DMG ERGOline® Control	SIEMENS 840D solutionline with DMG ERGOline® Control

\*\* Pure laser processing machine



Laser power: Fibre laser with max. 200 Watt output with various focal lengths.

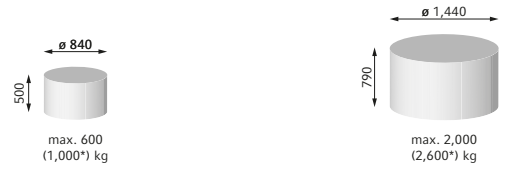

LASERTEC 210 Shape

## Unique technology combination: 5-axis milling and laser structuring in XXL.

LASERTEC 210 Shape provides a universal solution for 5-axis milling / laser complete machining of injection moulds up to 2.1 m work piece sizes. Also, the laser head can be flexibly integrated into the milling spindle via the HSK-A100 interface within 10 minutes. During the actual milling operation, all optical components of the laser are located outside the work area.

The portal series is successful and proven with more than 900 machines installed worldwide. It is based on a FEM-optimised machine concept with a portal design. The thermo-symmetrical structure, with liquid-cooled ball screws and cooled feed motors on all axes, provides the highest level of dynamics and long-term precision. The portal design of the LASERTEC 210 enables simple and effective machining of workpieces up to 10 t.

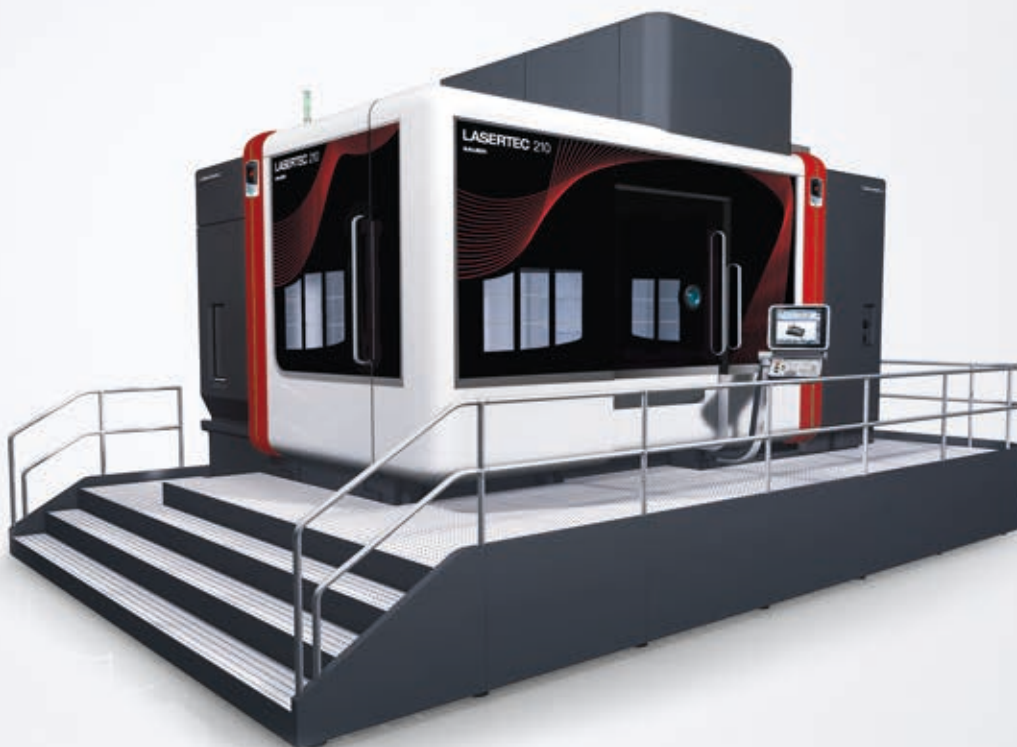

### Highlights

- + Thermo-symmetrical structure and 3-point support for quick setup
- + Short and constant projection of the milling head (no ram design) gantry design
- + Vertically traversable crossbeams featuring hydraulic weight compensation for the highest precision and dynamics
- + Infeed and rapid traverse up to 60 m/min
- + Machining of work pieces up to 8 t (optional: 10 t)



1 + 2: Replacement of the laser scanning head via a special changer device within 10 minutes; interface is the HSK 63 / 100 taper of the spindle 3: Laser texturing of a housing component 4: Surface structures in engine covers

		<b>LASERTEC 210 Shape (Portal)</b>	
Travel (X / Y / Z)	mm	1,800 / 2,100 / 1,250	
Max. work piece dimensions (5-axis)	mm	ø 2,000	
Max. load weight (5-axis)	kg	8,000 (Option: 10,000)	
Min. footprint (only machine)	m <sup>2</sup>	approx. 44	
Control	Type	SIEMENS 840D solutionline with DMG ERGOline® Control	
Rapid traverse in X / Y / Z	m/min	60 / 40 / 40	
<b>Connection Load and Aggregate</b>			
Connection power (incl. aggregate)	kVA	max. 103	
Operating voltage	V/Hz	400 / 50	
Machine / Unit weight	kg	42,000	
Machine dimensions W / D / H	mm	6,145 / 7,308 / 5,343	
Extraction dimensions W / D / H	mm	1,400 × 1,400 × 2,000	
Cooler dimensions W / D / H	mm	1,110 / 800 / 1,450	
Footprint W / D / H	mm	10,000 / 12,000 / 5,343	
<b>Control</b>			
CNC control		Siemens 840D solutionline	

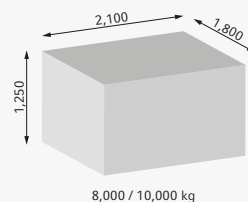





Perfect cutting edges, relief angles and chip breakers in precision tools

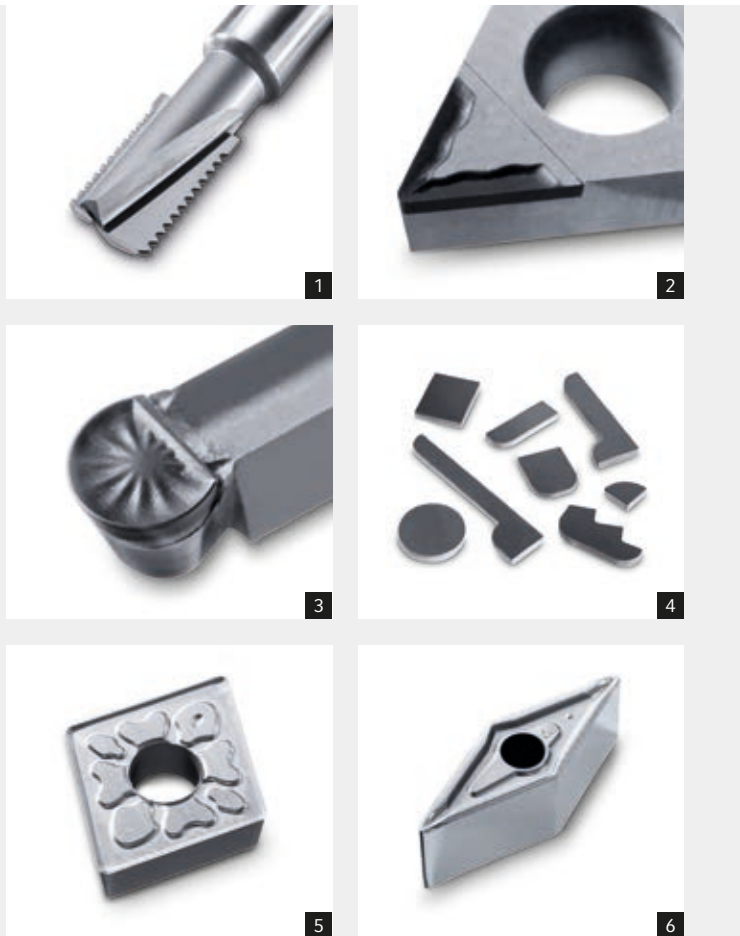

■ **Laser Produces “Super Sharp”**

Cutting without chipping

■ **ALL-IN-1**

Create cutting edges, relief angles and chip breakers in PCD / CVD-D in a single setup on one machine

■ **Introduction of Chip Breakers**

also in CVD-D and CBN for controlled chip breakage and longer tool life

■ **Separation and Cutting**

Of PCD blanks 10 × faster than wire cutting

■ **Prototype production**

of cemented carbide inserts and 5-axis laser machining of prototype inserts with clearance angle

■ **Extrusion die production**

of a cemented carbide extrusion die with  $Ra = 0,3 \mu m$  with a picosecond laser

LASERTEC PrecisionTool

## With the laser into a new dimension of PCD cutting edge machining.

Where conventional machining processes, such as grinding and eroding with high process forces as well as negative thermal reactions in diamond cutting materials, have already been pushed to their limits – innovative laser technology can unlock new machining possibilities. As a pioneer in this field, SAUER has many years of experience in laser machining of PCD, CVD-D, CBN and carbide.

The LASERTEC PrecisionTool Series covers the splitting of PCD blanks, introduction of chip breakers and finishing of cutting edges and relief angles. As a new laser source with high energy efficiency that uses no consumable materials, the manufacturing of these diamond tools is truly a “Green Technology”.

LASERTEC PrecisionTool

# Break-out-free cutting edges, relief angles and chip breakers in PCD / CVD-D, CBN.

## Laser Machining of PCD / CVD-D, CBN Highlights

- + Break-out-free cutting edges because the laser cuts through the diamond and binding material
- + Coarse-grained PCD grades can be processed without loss of quality
- + Chip breaker grooves can be incorporated in one setup with the cutting edge machining
- + Through the fine laser focus, inner radii of min 15 µm can be created
- + Lower operating costs because there are no costs for wire or grinding wheels
- + Contact-free precision machining without tool wear
- + Automation solutions for handling cutting inserts, end mill cutters, monoblock tools with HSK holder (different types of tools can be combined in one automation process)

## Laser vs. Grinding and Eroding.

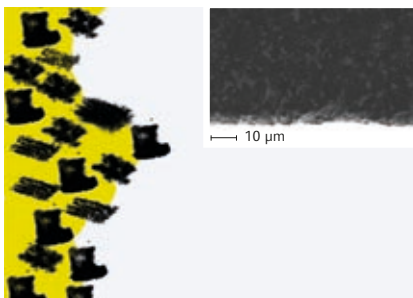

### Grinding

- + Break-out of the diamond grains
- + Coarse-grained PCD grades not grindable
- + Chip breakers not possible
- + Grinding disc wear limits edge radius

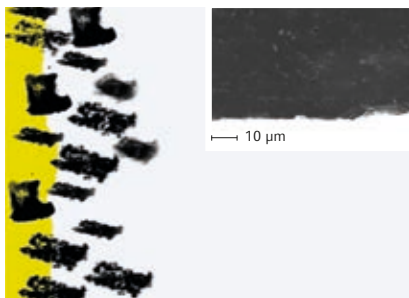

### Erosion

- + Diamond can not be eroded, only binding material
- + Coarse-grained PCD grades are not erodible chip breakers not possible
- + Wire diameter limits edge radius
- + Must be cut 2–3 times for good quality

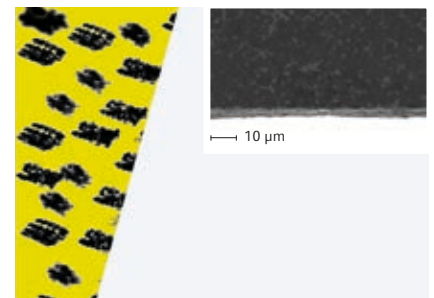

### Lasers

- + Laser works through diamond and binding material
- + Coarse-grained PCD grades can be processed without complication
- + Chip breakers are possible
- + Minimal edge radius (15 µm)
- + Perfect cutting edge without break-out



1: Chip breaker geometries in PCD 2: Cutting edge with relief angle in PCD  
 3: HSK tools with PCD inserts 4: ALL-IN-1: PCD cutting inserts 5: Separation  
 of PCD blanks 6: Carbide pressing tools 7: Carbide material prototypes

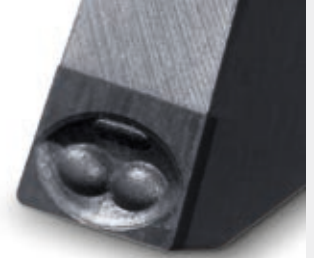

1



2



3



4



5



6



7

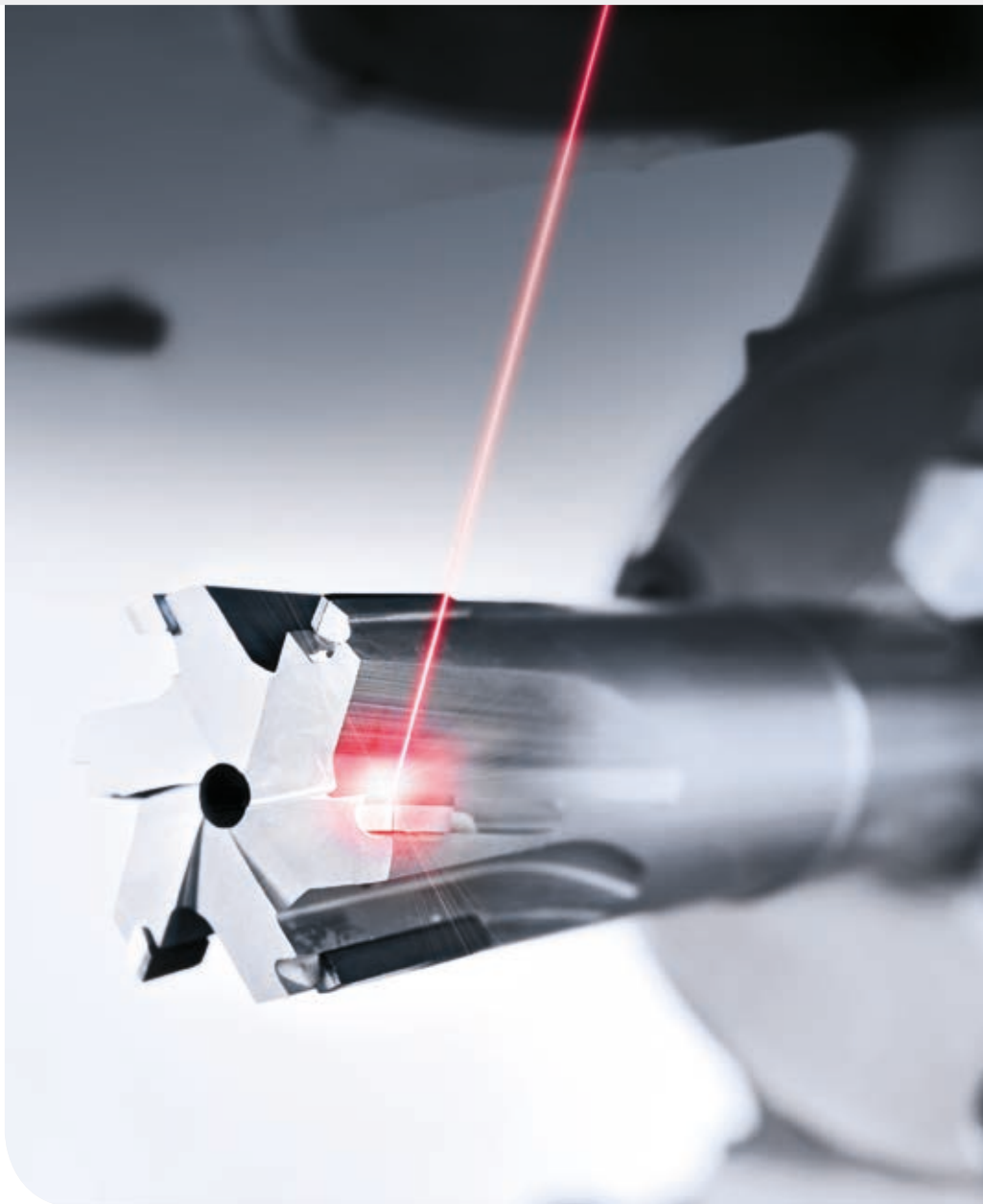

## Prototype manufacturing of carbide indexable cutting inserts and laser machining of carbide pressing tools.

### Carbide Machining Highlights

- + Simple and affordable solution for producing complete chip pressing tools geometries for prototypes
- + NEW picosecond laser: The high-end solution for the finishing of carbide extrusion dies with surface quality up to Ra 0.3  $\mu\text{m}$
- + LASERTEC 50 with picosecond laser: The 5-axis solution for complex prototypes and special machining with carbide

### Highlights

- + Highly dynamic 5-axis precision machine in the portal design with 5  $\mu\text{m}$  positioning accuracy, compact with a 3.5 m<sup>2</sup> footprint
- + Highly dynamic through linear drives in the X-, Y-, Z-axis with > 2 g
- + Integrated swivel rotary table (4<sup>th</sup> / 5<sup>th</sup> axis come standard) with torque technology, -10° / +130°
- + Precision cooling in all axes
- + Maximum workpiece size:  $\varnothing$  200 mm  $\times$  344 mm (may be limited by the position of the C axis)
- + User-friendly Siemens 840D solutionline CNC control

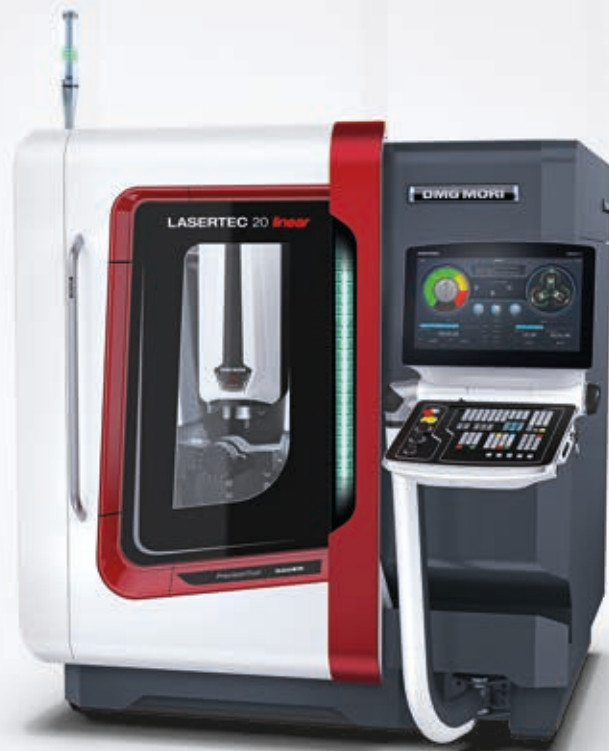

### LASERTEC 20 PrecisionTool

## Highly dynamic 5-axis precision machining on a 3.5 m<sup>2</sup> footprint.

The LASERTEC 20 combines dynamic performance, precision, compactness, versatility and intelligence in a high-tech machine. Linear drives in X / Y / Z with > 2 g, a 5-axis portal design with integrated NC swivel rotary table on a 3.5 m<sup>2</sup> footprint, high contour accuracy and the numerous application-specific LASERSOFT software features are only the most impressive highlights of this precision machine. The universal 5-axis kinematics with integrated A- and C-axis, long-term stable monoBLOCK<sup>®</sup> design as well as excellent positioning- and repeatability accuracy make the LASERTEC 20 ideal for high-tech manufacturing of precision tools and 3D fine cutting of precision parts for the watch and medical industries.

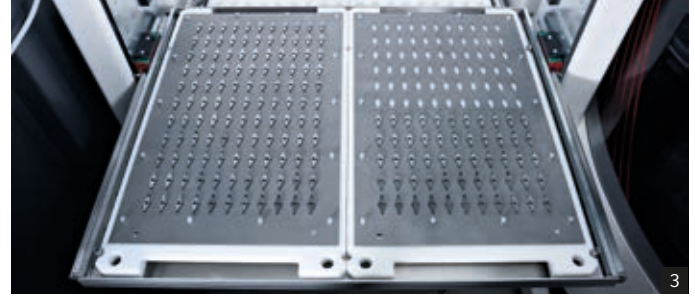

1: Pallet change  $\leq$  30 seconds 2: PH 10|100 linear magazine for the integration of max. 42 HSK tools  
3: Option: Retractable drawer for cutting inserts or shaft tools

## PH 10|100 Linear Magazine Automation

# Universal handling system with application-specific configuration levels.

The integrated PH 10|100 automation solution allows substitution of 42 HSK tools or several hundred cutting inserts (option: extendible pallet) into the work area from above. A work piece change takes  $\leq$  30 seconds. The compact, integrated design ensures optimal access to the work area and automation.

### Highlights

- + Compact linear magazine with the best accessibility and work piece automation from above
- + Max. 42 HSK tools with up to 10 kg total weight
- + Dynamic pallet change in  $\leq$  30 seconds
- + Option: Interchangeable grippers on the handling arm e.g. for HSK tools, cutting inserts or shaft tools
- + Compact and integrated design with a 6 m<sup>2</sup> footprint

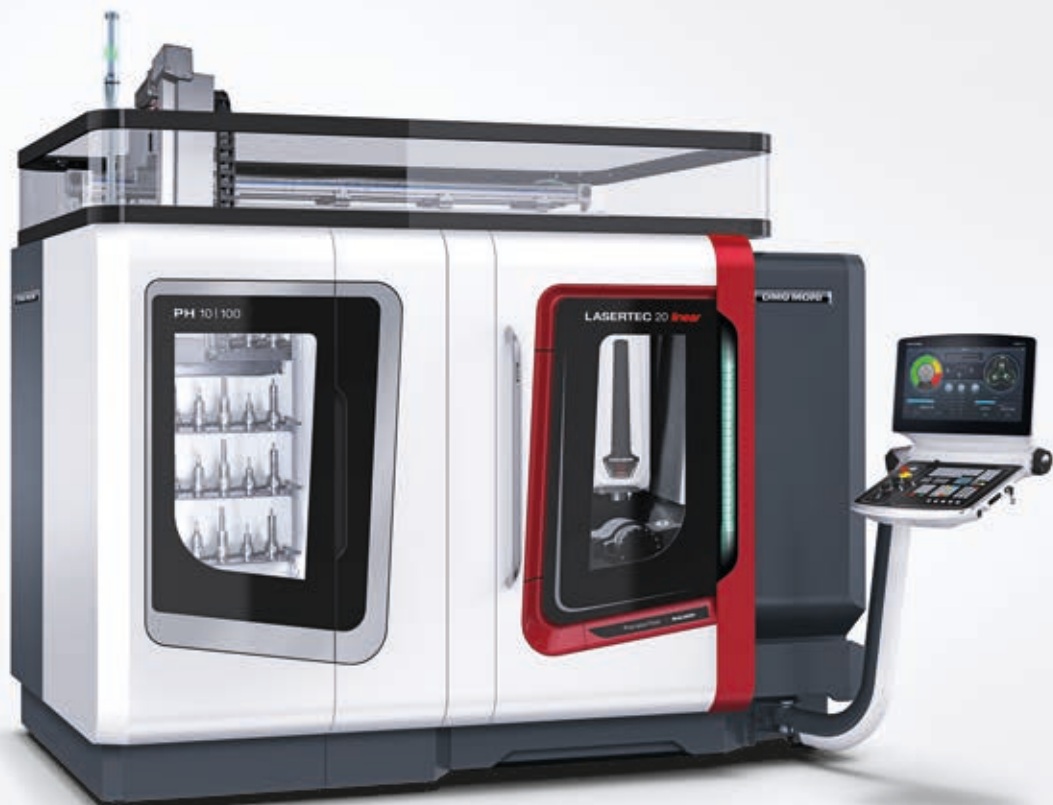



# Technical Data

Available as		PrecisionTool / FineCutting
<b>Work Area</b>		
X-axis	mm	200
Y-axis	mm	400
Z-axis (focusing axis)	mm	280
Table size (3 axes)	mm	–
Max. table load (3 axes)	kg	–
A-axis (swivel range)	Degrees	–10 to +130
C-axis (turning range / speed)	Degrees / rpm	360° / 150
Table size (5 axes)	mm	∅ 200
Max. table load (5 axes)	kg	10
<b>Traverse Speed</b>		
Rapid traverse in X / Y / Z	m/min	40 / 40 / 40
Acceleration	g	> 2
<b>Connection Load and Aggregate</b>		
Connection power (incl. aggregate)	kVA	max. 40
Operating voltage	V/Hz	400 / 50
Machine / Unit weight	kg	3,750
Machine dimensions W / D / H	mm	2,200 / 2,020 / 2,200
Extraction dimensions W / D / H	mm	340 / 660 / 1,400
Footprint W / D / H	mm	2,568 / 2,462 / 2,383
<b>Control</b>		
CNC control		Siemens 840D solutionline

## PH 10 | 100 Linear Magazine – Expansion Options (example)

	6* / 4**	6* / 4**
<b>Max. number of levels</b>		
<b>Number of places per level</b>	7	4
Module dimensions (centre of HSK intake to centre)	95 mm	190 mm
Max. tool dimensions	85 mm	140 mm
Max. tool length (from the HSK flange contact)	240 mm	240 mm

\* Tool length is max. 135 mm, \*\* Tool length is max. 240 mm

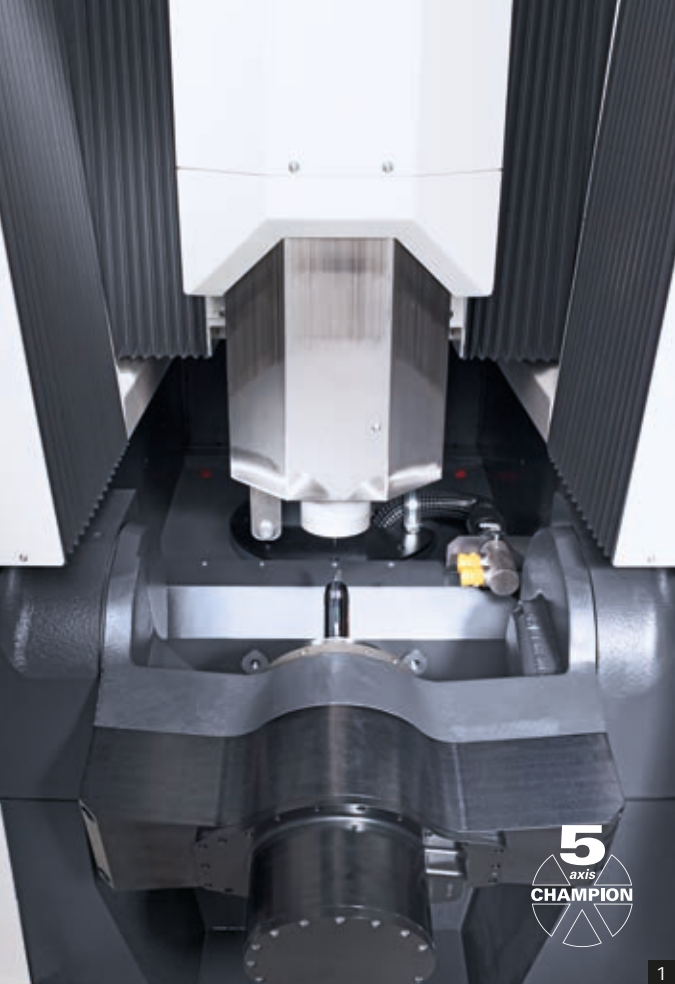

## 5-axis Machine Version with Integrated A- / C-axis.

- 1: Working area: 100 W fibre laser, laser head with new precision scanner and integrated infrared measuring sensor, HSK-63 interface integrated into the machine table (optional)  
 2: Laser machining a PCD thread milling cutter

### Long-term Stability

Stable, vibration-dampening cast mineral stand (approx. 3t) in the mono-BLOCK® design with a compact 3.5m<sup>2</sup> footprint.

### Linear Technology

Linear drives with > 2g max. acceleration as well as precision cooling in X / Y / Z (comes standard) / 6-month warranty.

### 3D Work Piece Measuring

High-precision tool measurement and workpiece positioning in the working area with the infrared measuring sensor.

### Zero Point Clamping System

Consistently precise work piece handling e.g. via the HSK interface.

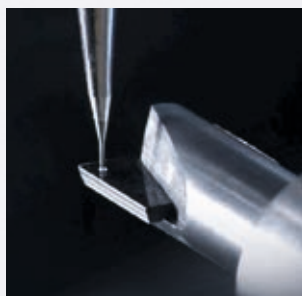

LASERSOFT PrecisionTool Software Package

# User-friendly software features for the manufacturing of all PCD tools.

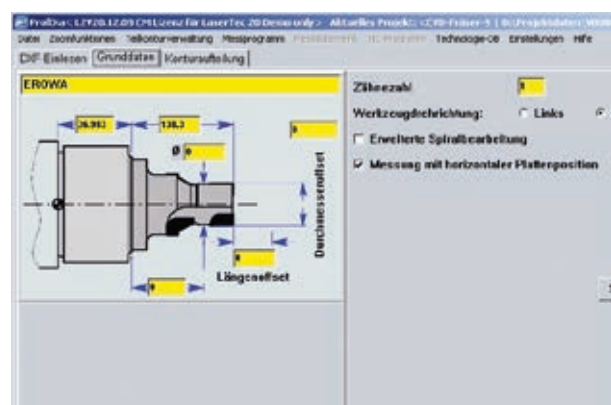
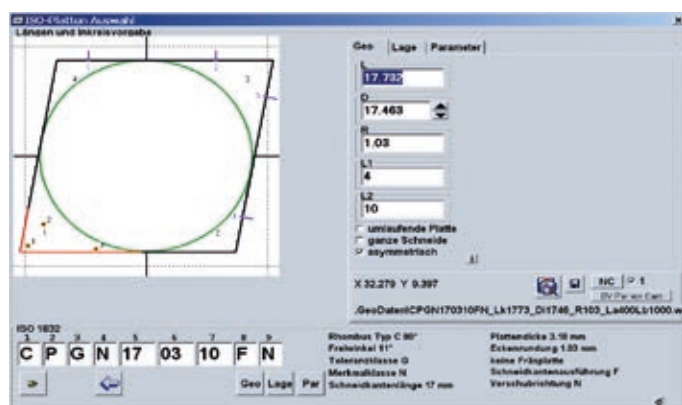
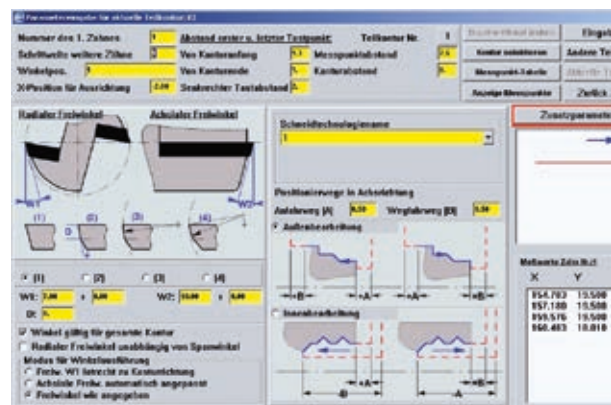
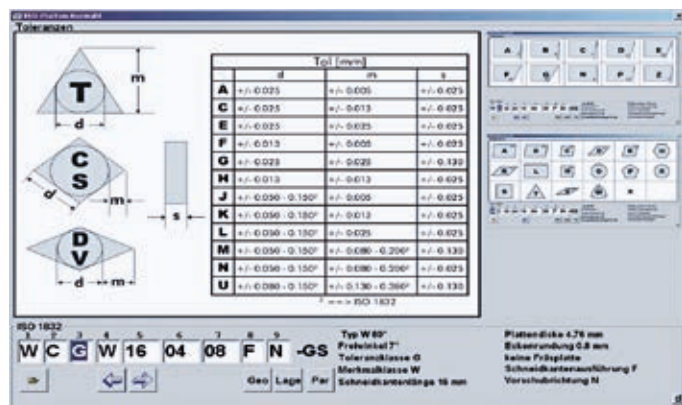

## LASERSOFT *insert*

- + Easy programming of standard cutting inserts by entering ISO codes or alternatively: menu-guided programming
- + Definition of measuring points for the automatic measurement of the inner circle and the position of the PCD insert

## LASERSOFT *endmill*

- + Programming of simple end mills to complex progressive dies
- + DXF interface for the input of the outer contour
- + Free definition of relief angle form and clearance angle for each contour element
- + Automatic measurement of the axial and radial position of the cutting inserts with automatic programme adjustment



The LASERSOFT 3D programming system, along with the powerful Siemens 840D contour control, makes CNC programming directly from 3D CAD data possible. The special software interface allows parameterised input of standard inserts for a highly efficient and productive laser machining.

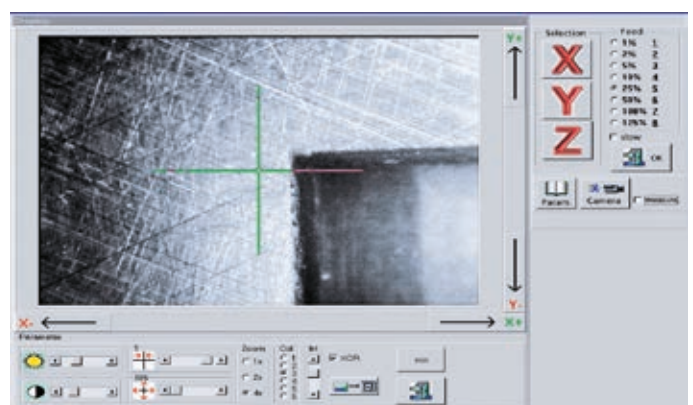
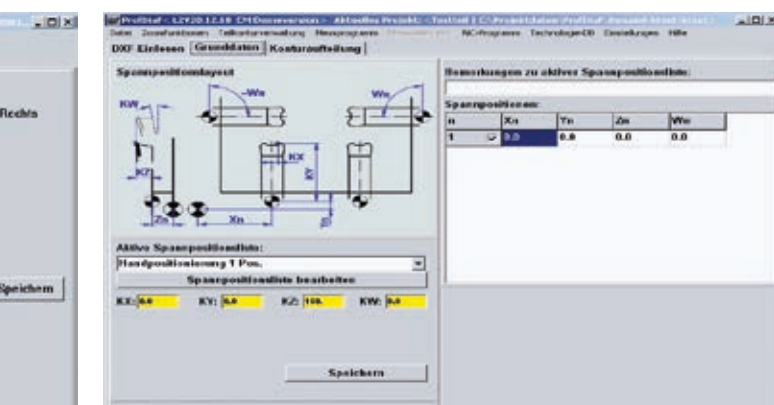
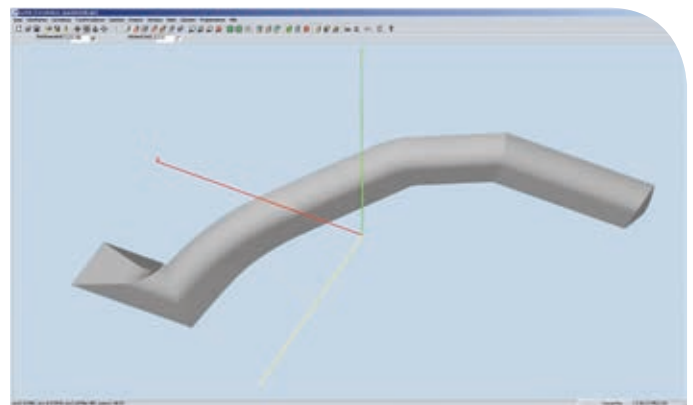
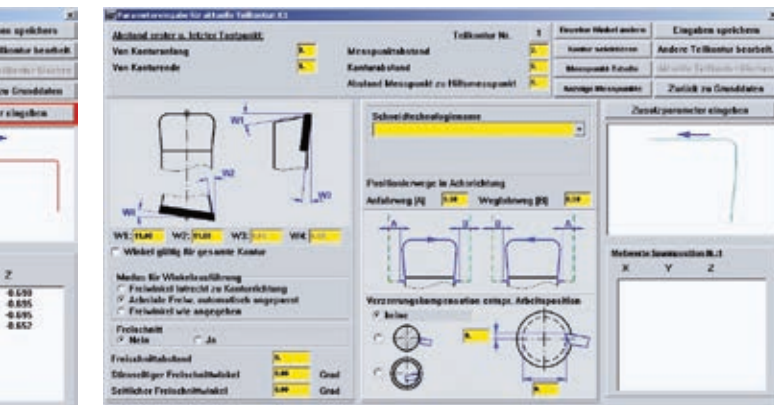

## LASERSOFT *turning*

- + For die plates with almost any contours
- + Programming of fixed mould tools via the DXF interface

## LASERSOFT *chipbreaker*

- + For die plates with almost any contours
- + Programming of fixed mould tools via the DXF interface



## Highly Dynamic 5-axis Laser Fine Cutting

Production of challenging 2D / 3D precision cutting parts  
for watches, stamping parts and the medical industry.





2



3



4



5

1: Watch plates 2: 20 µm cutting gap 3: Fine blanking part 4: Precision mechanical components for watch industry, with  $\varnothing$  50 µm drill holes 5: Milling tool for arthroscopic surgical applications

### LASERTEC FineCutting

## Precision laser cutting of sheets, pipes and 3D parts with up to 20 µm cutting gap.

The modular machine design with three to five CNC controlled axes allows the most flexible use of the LASERTEC 20 FineCutting for highly dynamic precision cutting of fine cutting parts in 2D and 3D. The laser source can always be adjusted according to type and performance for the relevant component in regards to quality, speed, and material. You can choose between fibre and Nd:YAG laser sources with different laser output performance.

Application examples for precision cut parts can be found in the watch / stamping / electronics and medical industry for production values with max. 4 mm thickness and min. laser cutting gap of 20 µm. Already today, stencils, apparatus parts, watch components, medical implants, arthroscopic instruments and spinnerets for textile fibres are made on the LASERTEC 20 FineCutting.

41

### Highlights

- + Application independent integration of different laser sources (fibre laser, QCW fibre laser, Nd:YAG)
- + Laser machining of watch / stencil / medical / fine-cut parts with a fibre laser
- + Up to 3 µm component precision (3-axis)
- + Min. laser cutting gap of 20 µm
- + Automation via robot loading possible







1



2

## STATE-OF-THE-ART

Technology leader in 5-axis precision drilling  
of cooling air holes for aerospace and IGT.



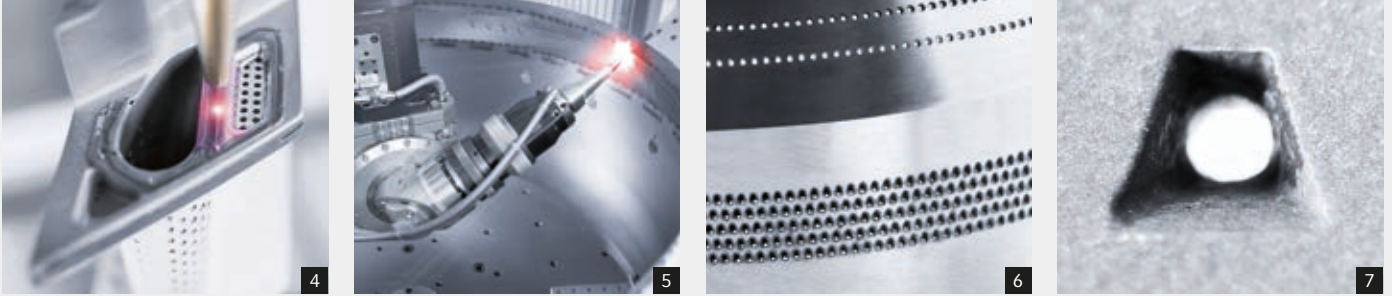

1: Turbine blade 2: Turbines-double vane 3: Laser welding of cover sheets  
4 + 5: Combustor, combustion chambers, reducers 6: Shaped hole geometry with conical outlet funnel

LASERTEC PowerDrill / PowerShape

## Cooling air holes in turbine components for aerospace and PowerGeneration.

The PowerDrill Series is specifically designed for 5-axis laser precision drilling of turbine blades and components for the aerospace industry and stationary gas turbines. Precision cooling air holes with partially conical and cylindrical shape are laser drilled in turbine vanes / blades, burners and combustion chambers as well as other components for high-pressure gas turbines using percussion drilling, trepanning or 5-axis simultaneous cutting.

The automatic measuring sensor positions the component exactly in the right position, negating the need for arduous clamping devices. After inserting the cylindrical cooling air holes, they can be expanded on the LASERTEC 50 / 80 via laser ablation by a conical outlet funnel. The PowerDrill software tools enable comfortable programming and machining of complex components.

	LASERTEC 50 PowerDrill	LASERTEC 50 PowerShape	LASERTEC 80 PowerDrill	LASERTEC 80 PowerShape	LASERTEC 130 PowerDrill
<b>Application Areas</b>					
<b>Turbine Vanes</b>					
Aircraft engines	•	•	•	•	
Industrial gas turbines			•	•	•
<b>Turbine Blades</b>					
Aircraft engines	•	•	•	•	
Industrial gas turbines			•	•	•
<b>Cover Sheets, Heat Shields</b>	•		•		
<b>Combustors, Burners, Reducers</b>					
Aircraft engines			•*		•**
Industrial gas turbines					•

\* Up to ø 450 mm (17"), \*\* Up to ø 1,300 mm (51")

### Highlights

- + Linear drives with acceleration  $> 1g$
- + Highly dynamic torque motors in both rotary axes (B- and C-axis)
- + High positioning accuracy of  $\leq 8 \mu\text{m}$
- + CCD camera and 3D measuring probe for fast setup
- + Massive, vibration dampening machine bed with 3-point support
- + User-friendly Siemens 840D solutionline CNC control (comes standard)



LASERTEC 50 PowerDrill

## Highly dynamic 5-axis laser precision machine with linear drives.

The LASERTEC 50 is a highly dynamic laser precision machine capable of handling challenging 5-axis machining with its built-in X- and Y-axis linear drives featuring  $> 1g$  acceleration as well as water-cooled torque drives in the 4<sup>th</sup> and 5<sup>th</sup> axis. This high flexibility along with numerous application-specific machine options and laser sources enable universal use of this machine size in almost all LASERTEC-technology fields.

With a footprint of only  $4\text{m}^2$  and relatively large work area featuring travels of  $500\text{ mm} \times 500\text{ mm} \times 700\text{ mm}$  in X / Y / Z, this machine not only stands out with its high dynamics, precision, flexibility and long-term stability, but also with its optimal accessibility and compactness.





1: Clearly structured working area with optimal workpiece accessibility 2: Laser nozzle with quick-change interface  
 3: Laser precision drilling of cooling air holes 4: Integrated NC swivel rotary table with torque drives  
 5: The linear motors and the laser are outside of the work area

Available as	
<b>Work Area</b>	
X-axis	mm
Y-axis	mm
Z-axis (focusing axis)	mm
Table size (3 axes)	mm
Max. table load (3 axes)	kg
A- / B-axis (swivel range)	Degrees
C-axis (speed)	Degrees
Table size (5 axes)	mm
Max. table load (5 axes)	kg
<b>Traverse Speed</b>	
Rapid traverse in X / Y / Z	m/min
Acceleration	g
Machine / Unit weight	kg
Footprint W / D / H	mm
<b>Control</b>	
CNC control	

PowerDrill / PowerShape	
	500
	500
	700
	400 x 500 (Work surface)
	150
	-100 to +160
	360° continuous
	ø 200
	14
	60 / 60 / 30
	1
	5,000
	3,700 / 4,250 / 2,400
	Siemens 840D solutionline

**LASERTEC 80**

- 1: 3D measuring probe for automatic work piece positioning
- 2: Stable, vibration dampening cast mineral stand for the highest stability



LASERTEC 80 / 130 PowerDrill

## Strong performance for the laser machining of turbine components up to XXL.

High positioning accuracy and dynamics of the X- / Y-axis, the Z-axis as a ball screw drive and rotary axes in the torque technology are just some of the LASERTEC 80 highlights. The X- / Y-cross table with direct drives and a massive machine bed with three-point support provide high-precision 5-axis laser machining. Integration of varying laser resonators and easy maintenance with optimal accessibility to the laser via a walk-in stand further enhances this offering.

The LASERTEC 130 sets the standard for drilling large turbine components. Two highly dynamic torque motors in the component axis of rotation and the laser head ensure the highest precision and fast processing. With the integrated focusing head changer, the LASERTEC 130 has a wide range of applications, including aerospace / power generation as well as 5-axis laser drilling for sizes up to 1,300 mm.



## LASERTEC 80

### Highlights

- + 5-axis laser precision milling of cooling air holes in turbine components
- + Linear drives in X / Y with 1.2g
- + 4<sup>th</sup> / 5<sup>th</sup> axis with torque technology
- + Automatic breakthrough detection guarantees faster machining
- + Highly precise Nd:YAG laser with 300 W / 500 W
- + CCD camera and 3D measuring probe for fast setup
- + Siemens 840D solutionline with special LASERSOFT PowerDrill software features
- + Also available as a PowerShape machine version for producing shaped hole geometries



3

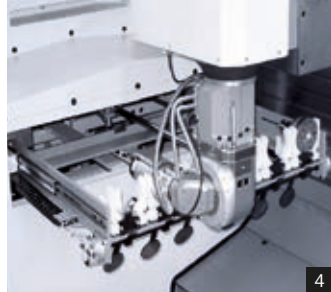

4



5

### LASERTEC 130

- 1: 5-axis laser drilling through a swivelling laser head and integrated NC rotary table
- 2: Automatic focusing head changer
- 3: Double collision protection in the laser head and laser nozzle

Available as		LASERTEC 80	LASERTEC 130
Work Area		PowerDrill / PowerShape	PowerDrill
X-axis	mm	800	1,300
Y-axis	mm	500	920
Z-axis (focusing axis)	mm	700	820
Table size (3 axes)	mm	900 × 600	–
Max. table load (3 axes)	kg	200	–
B-axis (swivel range)	Degrees	–100 to +150	±150
C-axis (speed)	Degrees	360° continuous	360° continuous
Table size (5 axes)	mm	∅ 200 / 400	∅ 450
Max. table load (5 axes)	kg	14 / 40	100 / 500 (static)
Traverse Speed			
Rapid traverse in X / Y / Z	m/min	120 / 120 / 30	30 / 30 / 30
Acceleration	g	1.2 (X / Y)	0.5 (X)
Connection Load and Aggregate			
Connection power (incl. aggregate)	kVA	max. 72	max. 92
Operating voltage	V/Hz	400 / 50	400 / 50
Machine / Unit weight	kg	7,000	18,000
Footprint W / D / H	mm	4,500 / 6,000 / 2,300	7,450 / 6,100 / 3,378
Control			
CNC control		Siemens 840D solutionline	Siemens 840D powerline



## LASERTEC 130

### Highlights

- + Highly dynamic 5-axis laser drilling of cooling air holes in combustors, vanes and blades (up to max. 1,300 mm)
- + Automatic focusing head changer
- + Swivel head (B-axis: ± 150°) and rotary table (360°, continuous) with torque motors
- + Double collision protection in the laser head and laser nozzle
- + Constant optical path for consistent drilling quality
- + High-speed shutter enables Synchro-Drill (synchronised laser drilling with a rotating component)
- + Siemens 840D powerline with special LASERSOFT combustor software features



PowerDrill Machine Options / Software Features

# Technology-specific machine features and optimal performance with LASERSOFT PowerDrill.

The powerful and user-friendly Siemens 840D CNC control provides maximum operator comfort and process reliability for the laser drilling of turbine components. All available LASERSOFT PowerDrill packages combine high-tech performance with customer value, delivering easy application-oriented programming and operation.

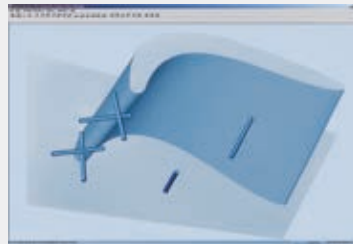

## Machine Options

### Integrated Measuring Probe

Integrated 3D measuring probe for automatic detection of the work piece position in the work area as well as the application of a “best fit” – algorithm, which automatically arranges the incoming cooling air holes in relation to the CAD model.

- + Customised number of measuring points possible
- + Descriptive, graphical illustration
- + Allows the use of simple work piece holders
- + Consistently precise laser machining of high-quality components

### Break-through-detection

Fully integrated optical sensor for automatic break-through detection during laser drilling of turbine components.

- + In-process regulation
- + Significantly reduced “back wall damage” and faster drilling
- + 20 % faster machining through optimal number of impulses
- + Selectable number of cleaning impulses depending on material and application

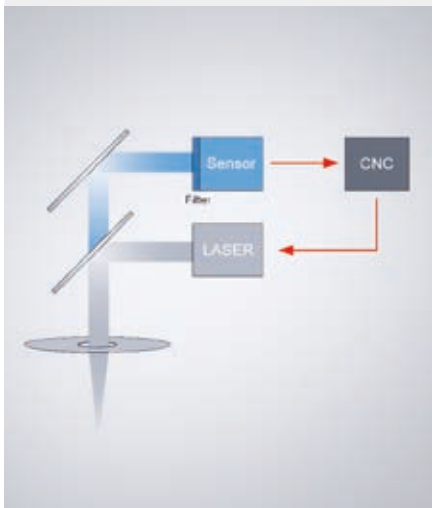

## Software Features

### LASERSOFT PowerDrill

- + 3D laser drilling programming system and special "repair & redrilling" software
- + Automatic probing and positioning of the work piece
- + Cycles for percussing and trepanning
- + 5-axis simultaneous machining of shaped drillings

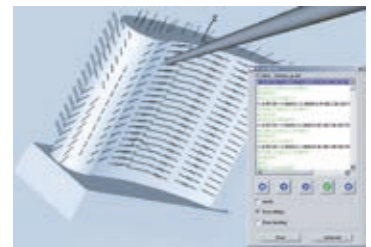

### LASERSOFT Simulation

- + Graphical 3D simulation incl. drilling positioning, tool track, collision control, and definition of drilling sequences
- + Editing of the CNC programmes during simulation possible

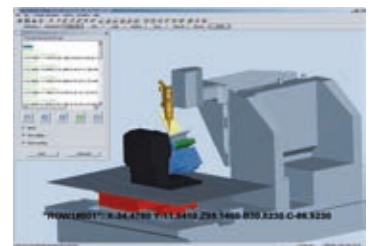

### LASERSOFT PowerShape

- + Production of shaped hole geometries via laser ablation
- + Transfer of work piece positioning data from the PowerDrill machine
- + Automatic programming of complete turbine blade from 3D CAD data

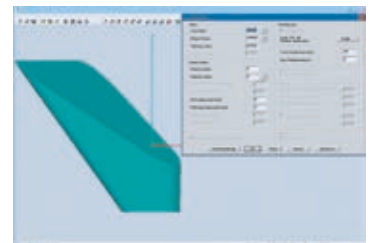

### LASERSOFT Weld

- + Special software for laser welding of cover sheets
- + Teach-in mode for defining welding points
- + Automatic contour recognition via CCD image data processing



### LASERSOFT Combustor

- + SynchroDrilling: Laser drilling during component rotation, single & multi-pulse operation possible and user-friendly parameterised programming system with 3D simulation
- + PatternDrilling: Laser drilling of segments and single rows possible

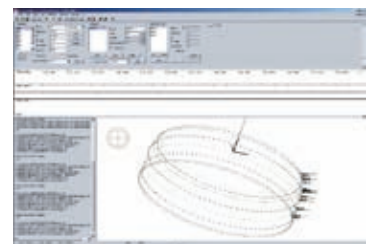

### LASERSOFT PartProbing / PartMapping

- + Measuring of rotation symmetrical components via a capacity sensor
- + Automatic compensation via axial and radial displacement

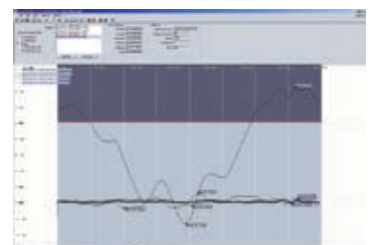

LASERTEC Series

# Floor Plans

**LASERTEC 20**

Front view

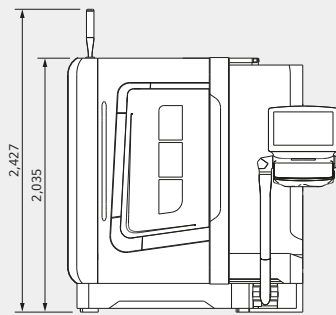

**LASERTEC 20**

Top view

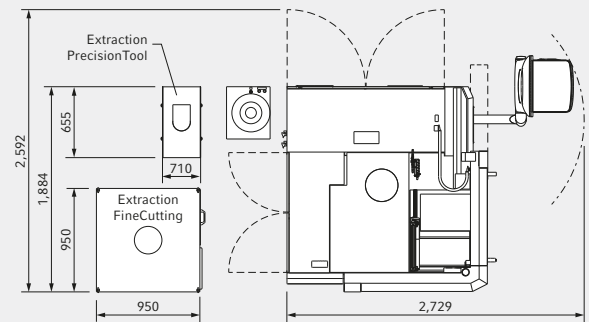

**LASERTEC 45**

Front view

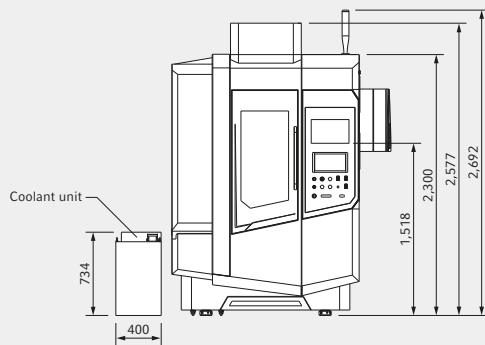

**LASERTEC 45**

Top view

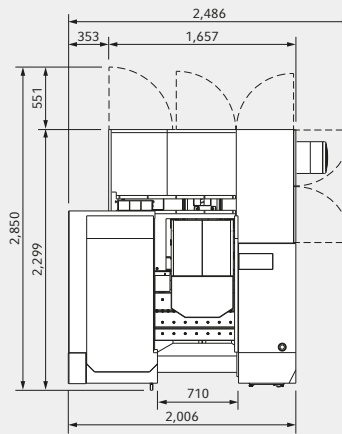

**LASERTEC 50**

Front view

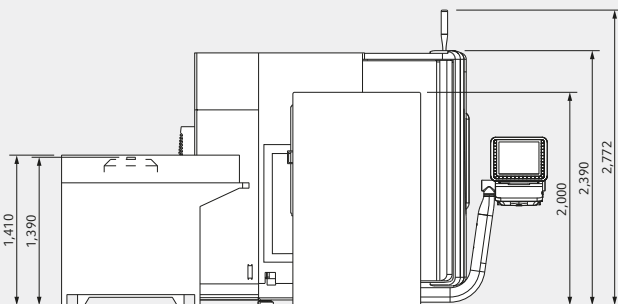

**LASERTEC 50**

Top view

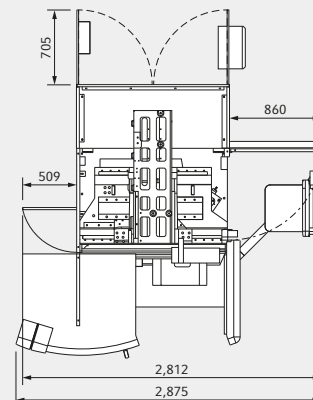



### LASERTEC 65

Front view

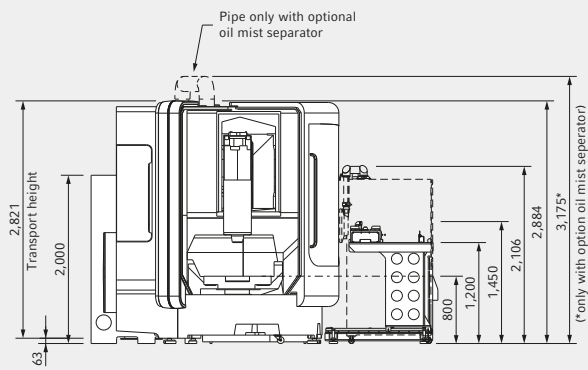

### LASERTEC 65

Top view

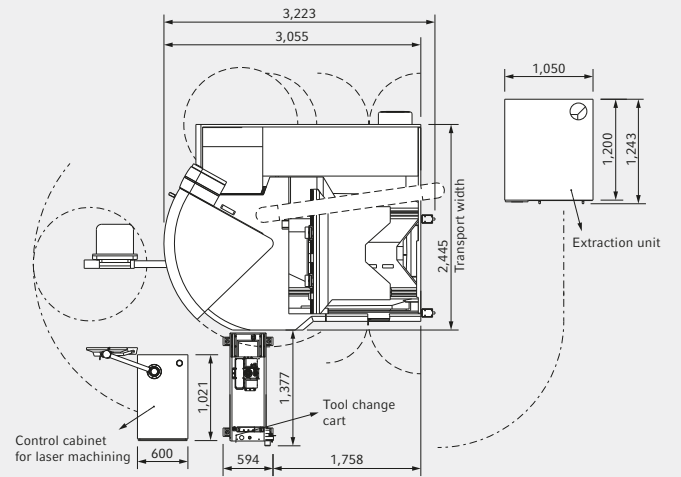

### LASERTEC 65 3D

Front view

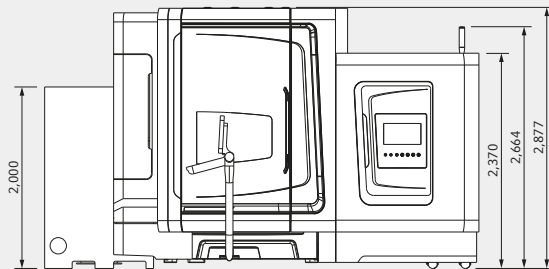

### LASERTEC 65 3D

Top view

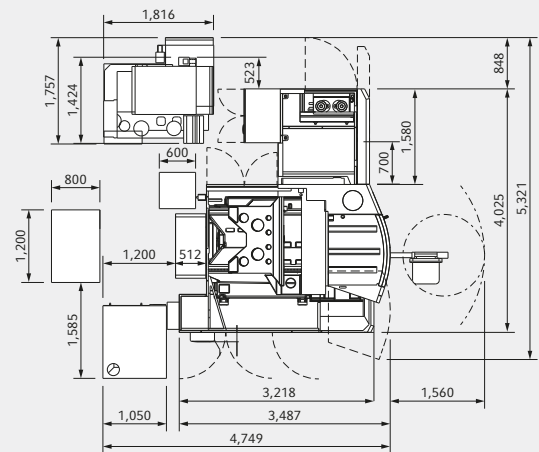

### LASERTEC 80

Front view

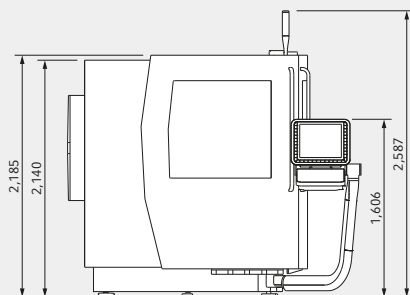

### LASERTEC 80

Top view

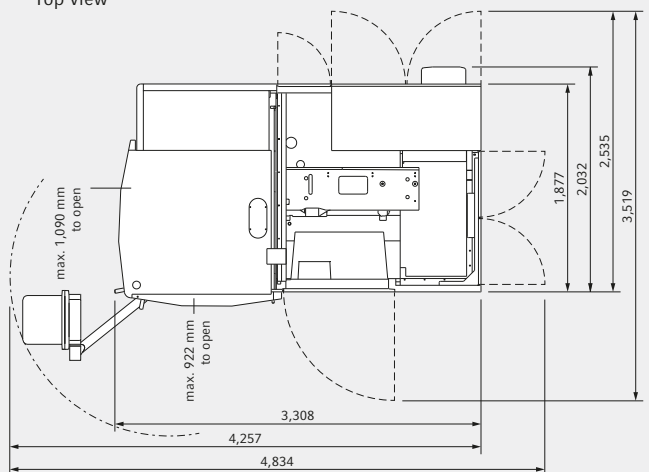

### LASERTEC 125

Front view

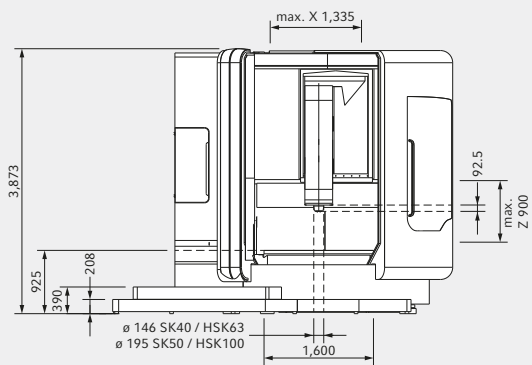

### LASERTEC 125

Top view

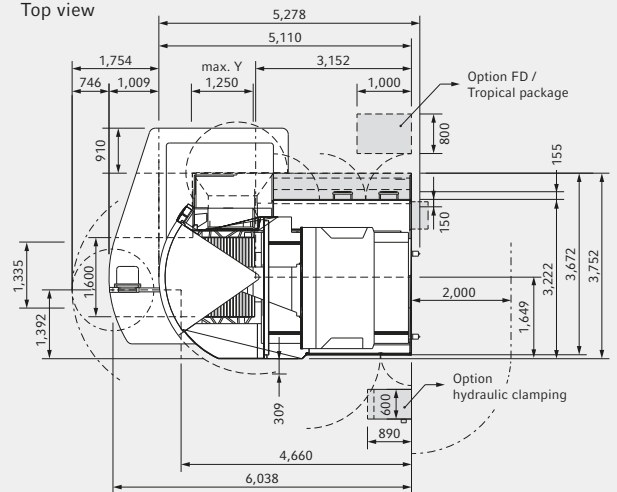

### LASERTEC 130

Front view

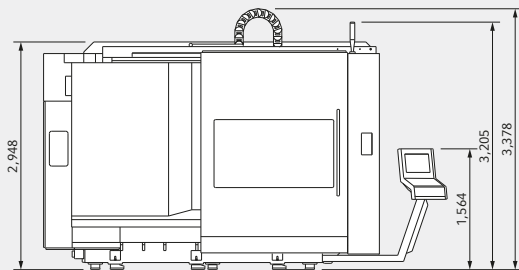

### LASERTEC 130

Top view

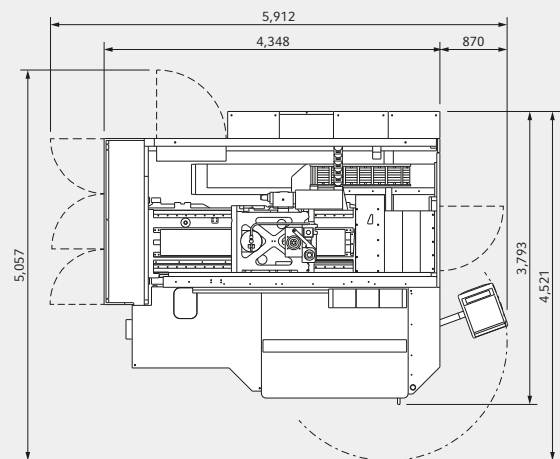

### LASERTEC 210

Front view

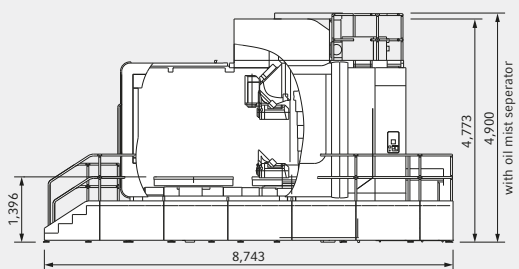

### LASERTEC 210

Top view

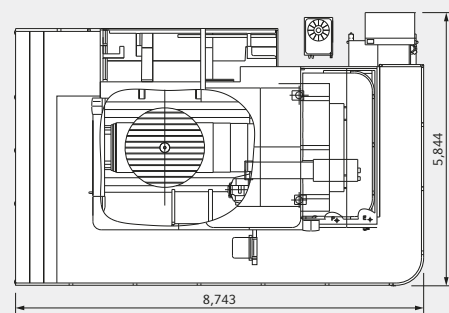

Progress Through Innovation

# Turnkey provider with impressive technology expertise.

In addition to the actual machine production, SAUER LASERTEC also offers you the required user expertise in all five technology areas and supports customers with feasibility studies, process optimisation as well as turnkey developments. SAUER GmbH also regularly hosts LASERTEC Technology Seminars for customers and interested parties on the latest machines in a modern LASERTEC Showroom in Pfronten.

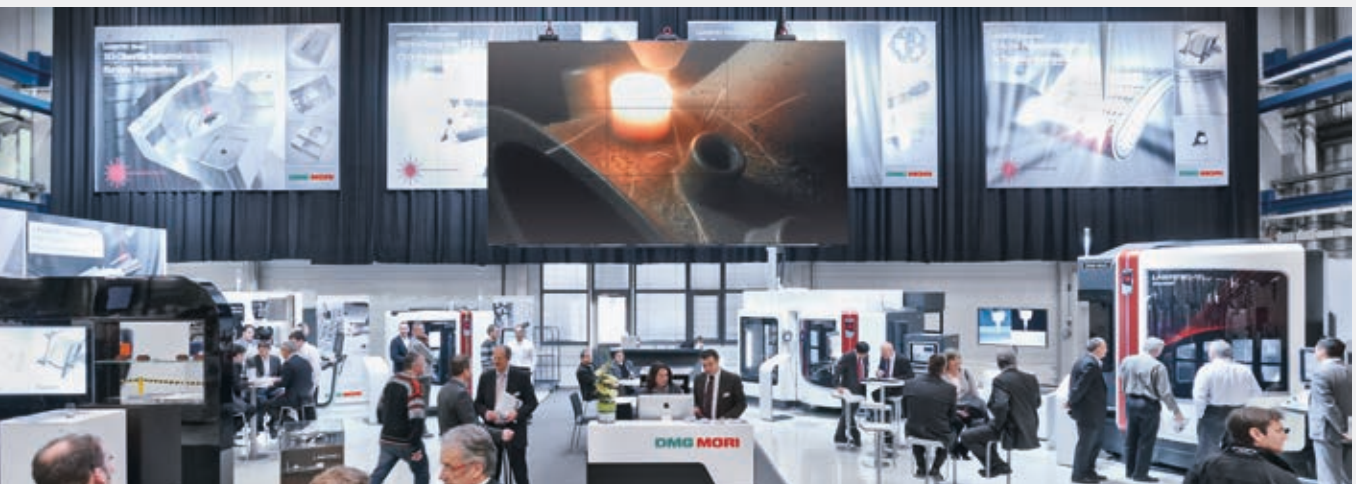

53



## LASERTEC Excellence

- + > 25 years of experience in laser precision machining
- + > 500 LASERTEC machines installed (worldwide)
- + Application and technology expertise: Training, customer support, complete turnkey solutions
- + Regular LASERTEC Technology Seminars



SAUER ULTRASONIC in Stipshausen supports the economical machining of advanced materials (e.g. glass, ceramic, corundum, fibre composite materials) with reduced process forces to enable surface quality of  $Ra < 0.2 \mu m$ .



## Headquarters

## Germany:

**DMG MORI Deutschland**

Riedwiesenstraße 19  
D-71229 Leonberg  
Tel.: +49 (0) 71 52 / 90 90 - 0  
Fax: +49 (0) 71 52 / 90 90 - 22 44

## Europe:

**DMG MORI Europe**

Lagerstrasse 14  
CH-8600 Dübendorf  
Tel.: +41 (0) 44 / 8 01 12 - 40  
Fax: +41 (0) 44 / 8 01 12 - 31

## Asia:

**DMG MORI Asia**

3 Tuas Link 1  
Singapore 638584  
Tel.: +65 66 60 66 88  
Fax: +65 66 60 66 99

## America:

**DMG MORI America**

2400 Huntington Blvd.  
Hoffman Estates IL 60192  
Tel.: +1 (847) 593 - 5400  
Fax: +1 (847) 593 - 5433

## Europe

**DMG MORI Austria**

Oberes Ried 11 · A-6833 Klaus  
Tel.: +43 (0) 55 23 / 6 91 41 - 0  
Fax: +43 (0) 55 23 / 6 91 41 - 100  
Service Hotline: +43 (0) 1 795 76 109

\_ **Stockerau**

Josef Jessernigg-Str. 16 · A-2000 Stockerau  
Tel.: +43 (0) 55 23 / 6 91 41 - 0  
Fax: +43 (0) 55 23 / 6 91 41 - 100

**DMG MORI Benelux**\_ **Nederland**

Wageningselaan 48  
NL-3903 LA Veenendaal  
Tel.: +31 (0) 318 - 55 76 - 11  
Fax: +31 (0) 318 - 52 44 - 29  
Service Turning: +31 (0) 318 - 55 76 - 33  
Service Milling: +31 (0) 318 - 55 76 - 34  
Service Fax: +31 (0) 318 - 55 76 - 10

\_ **Belgium**

Hermesstraat 4B · B-1930 Zaventem  
Tel.: +32 (0) 2 / 7 12 10 - 90  
Fax: +32 (0) 2 / 7 12 10 - 99  
Service: +32 (0) 2 / 7 12 10 - 94

**DMG MORI Czech**

Kaštanová 8 · CZ-620 00 Brno  
Tel.: +420 545 426 311  
Fax: +420 545 426 310  
Service: +420 545 426 320  
Service Fax: +420 545 426 325

\_ **Planá**

Chýnovská 535 · CZ-39111 Planá nad Lužnicí  
Tel.: +420 381 406 914  
Fax: +420 381 406 915

\_ **Slovensko**

Brianska 2 · SK-91105 Trenčín  
Tel.: +421 326 494 824

**DMG MORI France**

Parc du Moulin · 1, Rue du Noyer  
B.P. 19326 Roissy-en-France  
F-95705 Roissy CDG Cedex  
Tel.: +33 (0) 1 / 39 94 68 00  
Fax: +33 (0) 1 / 39 94 68 58

\_ **Lyon**

Parc des Lumières  
1205, Rue Nicéphore Niepce  
F-69800 Saint-Priest  
Tel.: +33 (0) 4 / 78 90 95 95  
Fax: +33 (0) 4 / 78 90 60 00

\_ **Toulouse**

Futuropolis Bat. 2 · 2, Rue Maryse Hilsz  
F-31500 Toulouse  
Tel.: +33 (0) 5 / 34 25 29 95  
Fax: +33 (0) 5 / 61 20 89 19

\_ **Haute-Savoie**

Espace Scionzier  
520 avenue des Lacs · F-74950 Scionzier  
Tel.: +33 (0) 4 / 50 96 41 62  
Fax: +33 (0) 4 / 50 96 41 30

**DMG MORI Hungary**

Vegyész u. 17-25 · B. Building  
H-1116 Budapest  
Tel.: +36 1 430 16 14  
Fax: +36 1 430 16 15  
Service Hotline: +36 1 777 90 57

**DMG MORI Ibérica**

Pol. Ind. Els Pinetons  
Avda. Torre Mateu 2-8 · Nave 1  
E-08291 Ripollet · Barcelona  
Tel.: +34 93 586 30 86  
Fax: +34 93 586 30 91

\_ **Madrid**

C / Alcañiz 23  
E-28042 Madrid  
Tel.: +34 91 66 99 865  
Fax: +34 91 66 93 834

\_ **San Sebastián**

Edificio Igaraburu  
Pokopandegi, 11 Oficina 014  
E-20018 San Sebastián  
Tel.: +34 943 100 233  
Fax: +34 943 226 929

**DMG MORI Italia**

Via G. Donizetti 138  
I-24030 Brembate di Sopra (BG)  
Tel.: +39 035 62 28 201  
Fax: +39 035 62 28 210  
Service Fax: +39 035 62 28 250

\_ **Milano**

Via Riccardo Lombardi 10  
I-20153 Milano (MI)  
Tel.: +39 02 48 94 921  
Fax: +39 02 48 91 44 48

\_ **Padova**

Via E. Fermi 7  
I-35030 Veggiano (PD)  
Tel.: +39 049 900 66 11  
Fax: +39 049 900 66 99

**DMG MORI Middle East**

Jebel Ali Free Zone · JAFZA Towers 18  
Floor 24 · Office 3  
PO Box 262 607 · Dubai, U.A.E.  
Tel.: +971-4-88 65 740  
Fax: +971-4-88 65 741

**DMG MORI Polska**

ul. Fabryczna 7  
PL-63-300 Pleszew  
Tel.: +48 (0) 62 / 7428 000  
Fax: +48 (0) 62 / 7428 114  
Service: +48 (0) 62 / 7428 285

**DMG MORI Romania**

Road Bucuresti  
Pitești, DN7, km 110  
Platforma IATSA  
RO-117715 Pitești · Stefanesti  
Tel.: +40 2486 10 408  
Fax: +40 2486 10 409

**DMG MORI Russia**

Nowoholowskaja-Strasse 23/1  
RUS-109052 Moscow  
Tel.: +7 495 225 49 60  
Fax: +7 495 225 49 61

\_ **Jekaterinburg**

ul. Sofi Kowalewskoj 4, litera Z  
RUS-620049 Jekaterinburg  
Tel.: +7 343 379 04 73  
Fax: +7 343 379 04 74

\_ **St. Petersburg**

pr. Obuhovskoy Oborony 271, litera A  
RUS-192012 St. Petersburg  
Tel.: +7 812 313 80 71  
Fax: +7 812 313 80 71

**DMG MORI Scandinavia**\_ **Danmark**

Robert Jacobsens Vej 60 · 2.tv  
DK-2300 København S  
Tel.: +45 70 21 11 11  
Fax: +45 49 17 77 00

\_ **Sverige**

EA Rosengrens gata 5  
S-421 31 Västra Frölunda  
Tel.: +46 31 348 98 00  
Fax: +46 31 47 63 51

\_ **Norge**

Bergsli Metallmaskiner AS  
Gateadresse: Bedriftsveien 64  
N-3735 Skien  
Postadresse: Postboks 2553  
N-3702 Skien  
Tel.: +47 35 50 35 00  
Fax: +47 35 50 35 70

\_ **Finland**

Fastems Oy Ab  
Tuotekatu 4  
FIN-33840 Tampere  
Tel.: +358 (0)3 268 5111  
Fax: +358 (0)3 268 5000

\_ **Baltic states**

Fastems UAB  
Kalvarijos str. 38  
LT-46346 Kaunas  
Tel.: +370 37 291567  
Fax: +370 37 291589

**DMG MORI Schweiz**

Lagerstrasse 14  
CH-8600 Dübendorf  
Tel.: +41 (0) 44 / 8 24 48 - 48  
Fax: +41 (0) 44 / 8 24 48 - 24  
Service: +41 (0) 44 / 8 24 48 - 12  
Service Fax: +41 (0) 44 / 8 24 48 - 25

**DMG MORI South East Europe**

9<sup>th</sup> km. National Road Thessaloniki –  
Moudanion · PO Box: 60233  
GR-57001 Thessaloniki  
Tel.: +30 2310 47 44 86  
Fax: +30 2310 47 44 87

**DMG MORI Turkey**

Ferhatpaşa Mah. Gazipaşa Cad. NO: 11  
TR-34885 Ataşehir · İstanbul  
Tel.: +90 216 471 66 36  
Fax: +90 216 471 80 30

**DMG MORI UK**

4030 Siskin Parkway East  
Middlemarch Business Park  
Coventry CV3 4PE · GB  
Tel.: +44 (0) 2476 516 120  
Fax: +44 (0) 2476 516 136

**DMG / MORI SEIKI Europe AG**

Lagerstrasse 14, CH-8600 Dübendorf  
Tel.: +41 (0) 44 / 8 01 12 - 40, Fax: +41 (0) 44 / 8 01 12 - 31  
info@dmgmori.com, www.dmgmori.com