

**AutoCAD® 2009
2D Training Manual**

Written by Kristen S. Kurland

C o p y r i g h t © 2 0 0 8

AutoCAD is a registered trademark of Autodesk, Inc.

Chapter 1

Introduction

1.1 Launching AutoCAD

1. **Choose** Start from the Windows program manager.
2. **Choose** Programs, **Autodesk ,AutoCAD 2009.**
3. **Click** the AutoCAD 2009 for Windows icon.

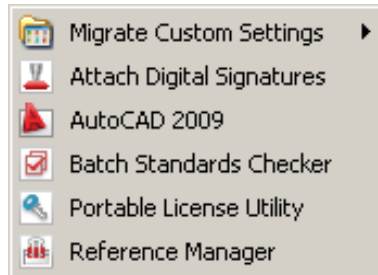

1.2 Text and Graphics Screens

The graphics screen and the text screen are two different screens available in the drawing editor.

1. **Press** Function key **F2** on the keyboard.

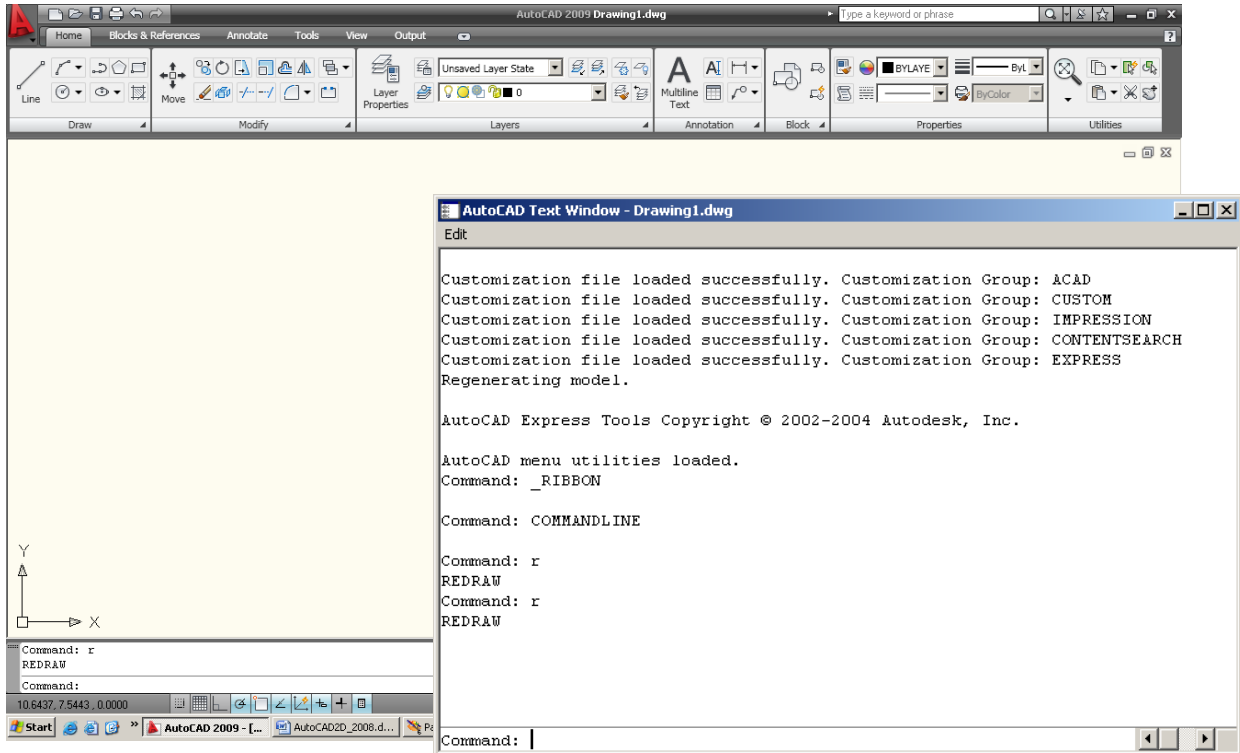

TIPS:

The Cursor must be in the drawing window in order to select objects.

Maximize the AutoCAD windows to be full screen. This will make the drawings bigger and easier to read.

Use ALT + TAB to move between Windows applications.

1.3 Cursor

Controls the size of the crosshair. The allowable range is from 1 to 100 percent of the total screen. At 100% the ends of the crosshair are never visible. When the size is decreased to 99% or below, the crosshairs have a finite size, and the crosshairs' ends are visible when moved to the edge of the graphics area. The default size is 5%.

1. Choose **Tools, Options...**
2. Click the Display TAB.
3. Drag the slider bar in under crosshair size to set the cursor size.

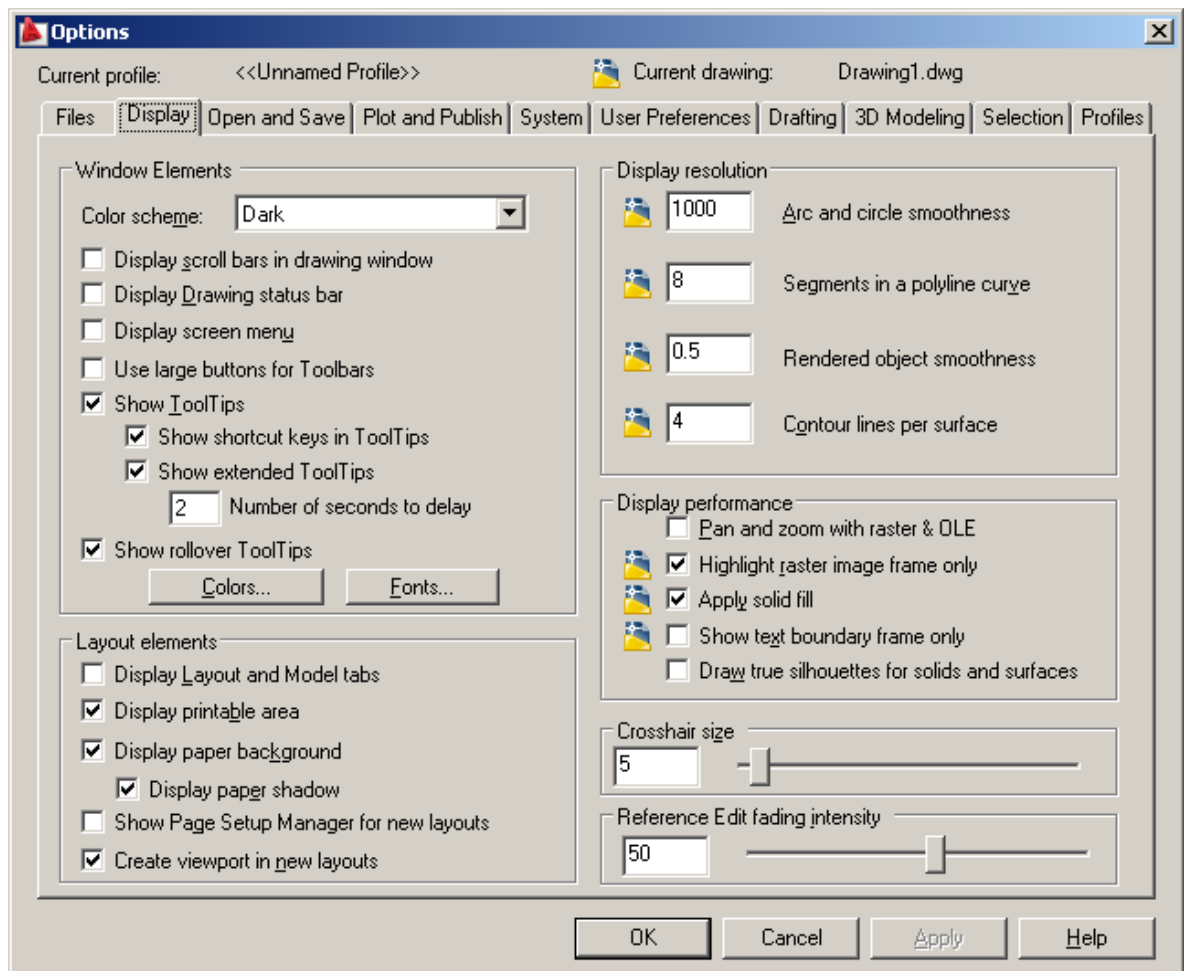

1.4 Canceling a Command

1. Press the **ESCAPE (ESC)** key on the keyboard.



TIP: Pressing ESC twice clears nested commands.

1.5 Menus and Colors

Menu Browser

1. Click on the A icon in the upper left corner of the drawing area.
2. Click the desired pulldown menu.
3. Click on the command to be executed from the pulldown.

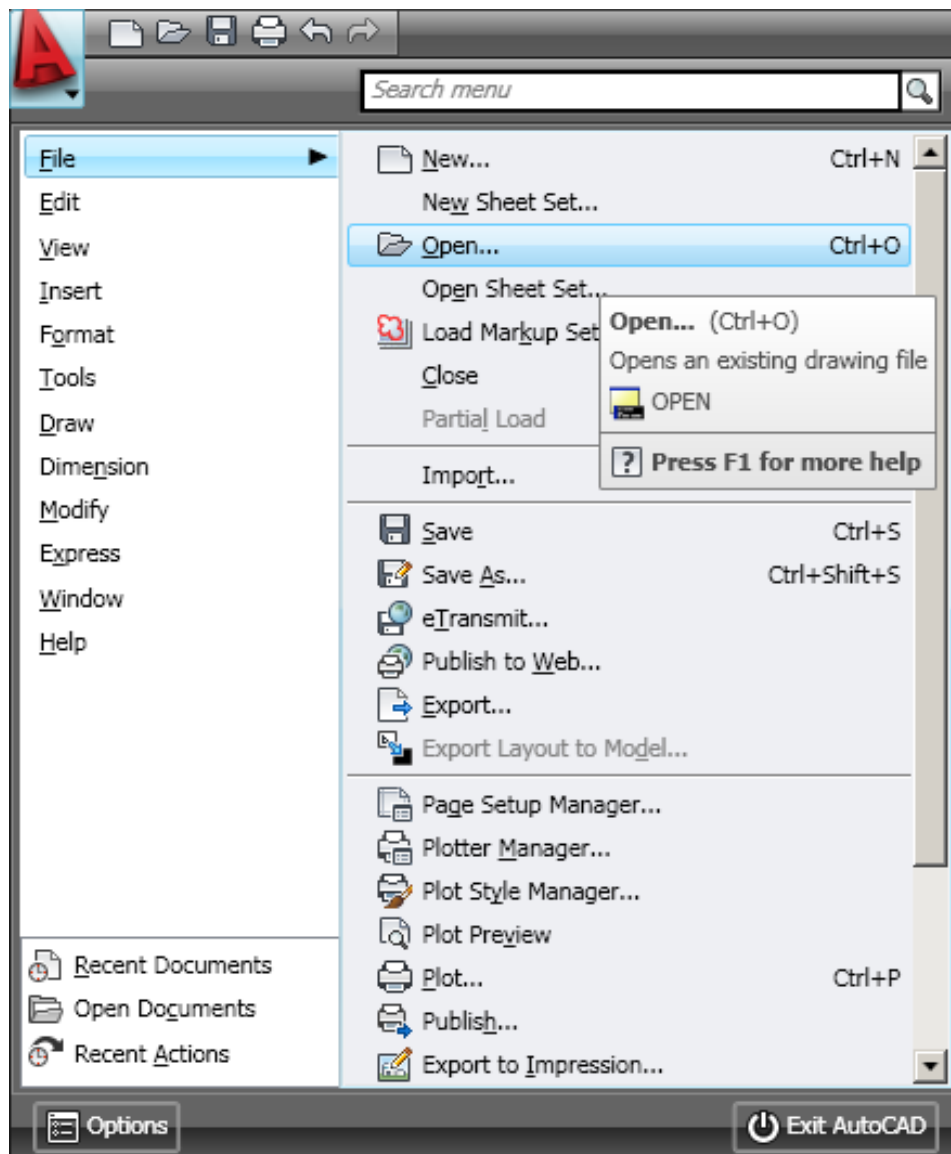

Quick Access Toolbar

1. Click on one of the following icons for quick access to commands QNEW, OPEN, SAVE, PLOT, and UNDO/REDO.



Right-click the Quick Access toolbar and click Customize Quick Access Toolbar. The Customize User Interface dialog opens and displays the list of commands available.

Drag commands you want to add from the command list pane in the Customize User Interface dialog box to the Quick Access toolbar.

Info Center

Quickly search for a variety of information sources, access product updates and announcements, and save topics with InfoCenter.



Ribbon

The ribbon provides a single, compact placement for operations that are relevant to the current workspace. It eliminates the need to display multiple toolbars, reducing clutter in the application window. The ribbon maximizes the area available for work using a single compact interface.

The ribbon can be displayed horizontally, vertically, or as a floating palette. The horizontal ribbon is displayed at the top of the drawing window by default when you create or open a drawing.

You can create your own panels to display on the ribbon; you can also modify the commands and controls on existing ribbon panels.



1.6 Workspaces

You can switch between the workspaces from the menu browser.

1. Click the Workspace switching icon in the lower left corner of the screen.



2. Click on one of the following workspace options

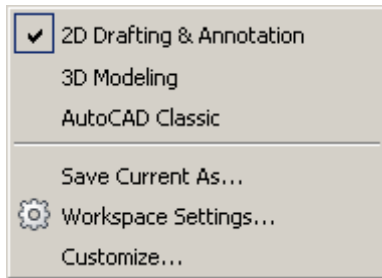

AutoCAD classic workspace

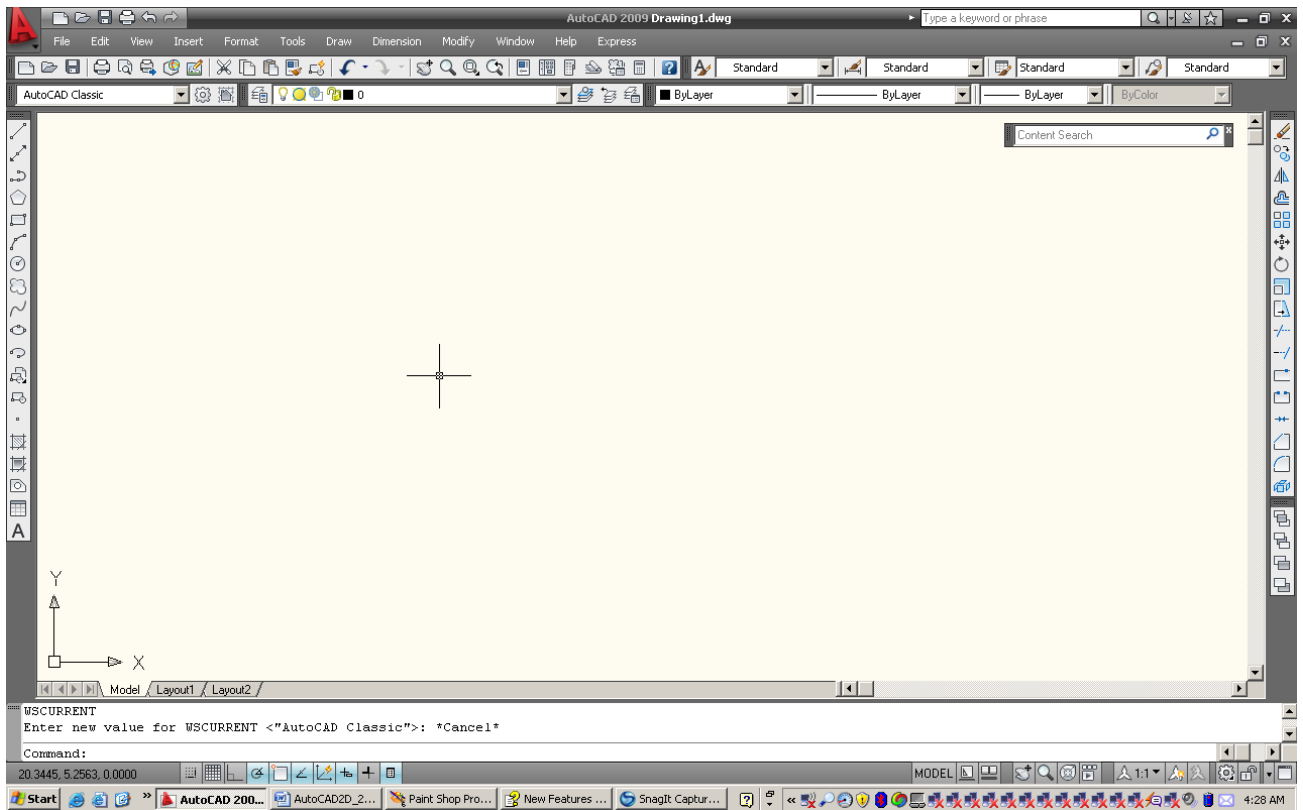

1.7 AutoCAD Classic Toolbars

Toolbars can be docked on the screen or they can float about the screen.

To Float a Toolbar:

1. Choose the gray border surrounding each tool.
2. Drag the toolbar to any area on the screen.

To Dock a Toolbar:

1. Choose the title or gray border of the toolbar.
2. Drag the toolbar to the top, bottom, left, or right area of the graphics display.

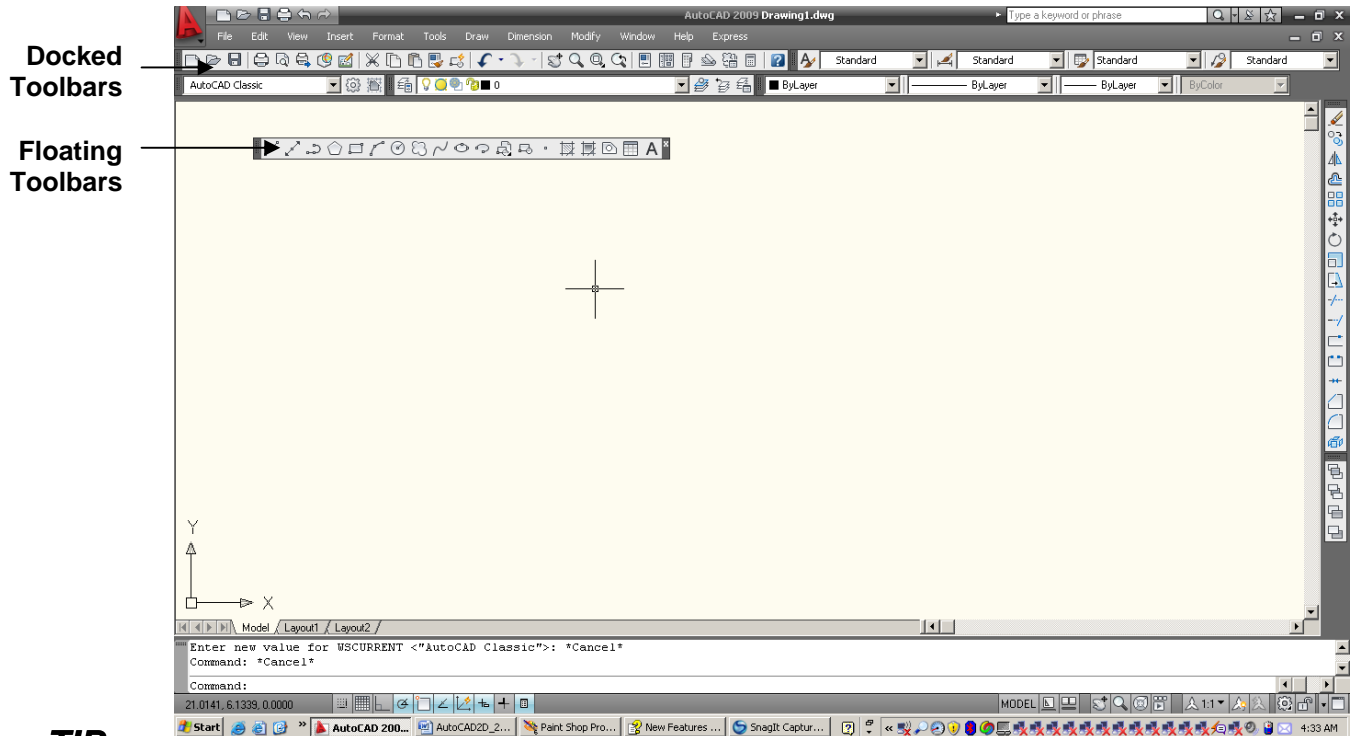

TIP:

-Holding the CTRL key while dragging will prevent docking.

Loading Toolbars

Right-clicking on an icon in any toolbar

This will show a list of all available toolbars.

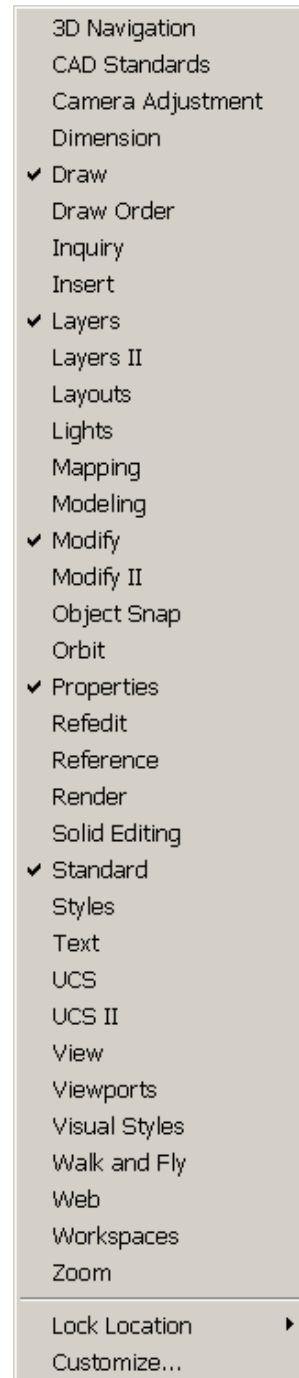

Help Tooltips

1. Move the mouse to the toolbar but do not pick the button.



1.8 Status Bar and Command Prompt

The Status Bar is the area below the command line that shows messages as well as coordinates, modes, and the current time.

To activate SNAP, GRID, ORTHO, OSNAP, MSPACE, PSPACE, and TILE, you must double-click on the mode to change.

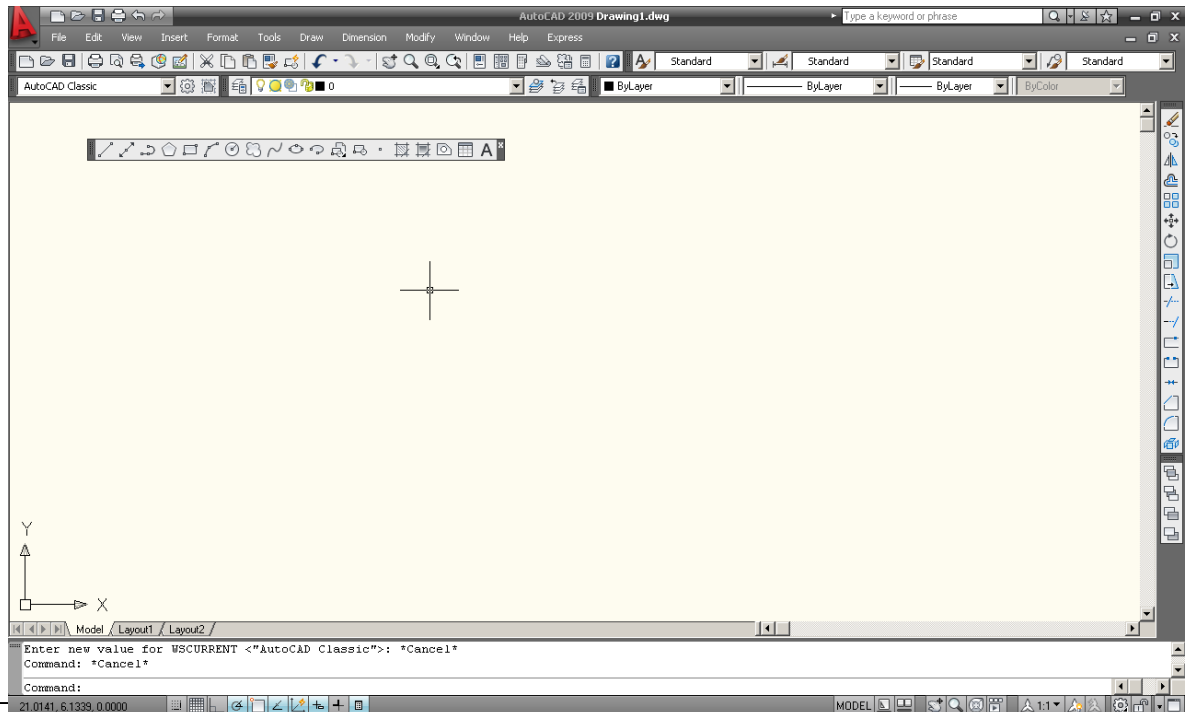

Status Bar

TIP:

- Right click on the blank area of the status bar to see the tools to turn off/on.

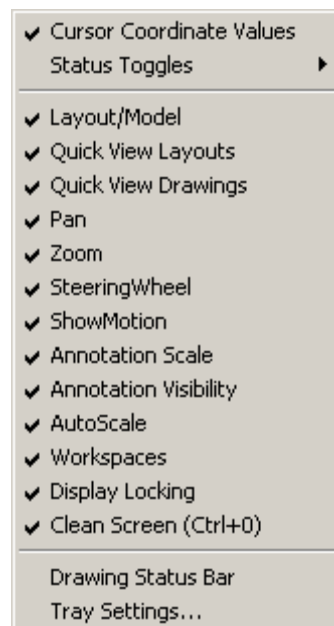

1.9 Typing Commands

Typing a Command

All AutoCAD commands can be typed in at the command line. Many commands also have one or two letter aliases that can also be typed as shortcuts to the commands.

1. Type the desired command at the command prompt.

Command : **LINE**

or

2. Type the command's alias.

Command: **L**

3. Press **ENTER**.

4. Type an option at the command prompt.



TIP: Many AutoCAD commands require you to press ENTER to complete the command. You know you are no longer in an AutoCAD command when you see a blank command line.

Reissuing the Last Command

The last used AutoCAD command can be re-entered by one of the following three methods of ENTER. The ENTER key on the keyboard will always act as ENTER, the SPACEBAR and RIGHT MOUSE will act as enter most of the time (exceptions include placing TEXT).

1. Press the **ENTER** key on the keyboard

or

2. Press the **Space bar** on the keyboard.

or

3. Click the right mouse button.

1.10 Pointing Device (Mouse)

AutoCAD uses either a mouse or digitizing tablet to select objects in a drawing.

Left Mouse Button

Used to pick or select objects

1. Click the left mouse button to select an object area in the drawing.
2. Press **ESC twice** to deselect an object (or to cancel a command).

Right Mouse Button

Used to enter a command, repeat last command, or access shortcut menus.

1. Click the right mouse button.

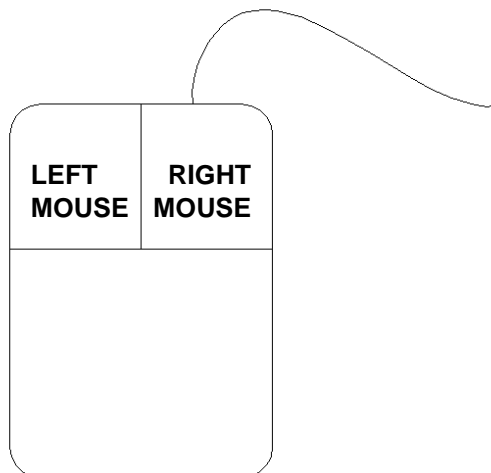

TIPS:

- SHIFT + the right mouse button brings up the object snap menus.
- Various screen locations for the mouse brings up different menus.

1.11 Undo and Redo

Reverses the last action.

1. Choose **Edit, Undo**.
or
2. Click the Undo icon. 
or
3. Press **CTRL + Z**.
4. Type U at the command prompt to undo the last command.
Command: **U**

Redo

Reverses the effects of a single UNDO or U command.

1. Choose **Edit, Redo**.
or
2. Click the Redo icon. 
or
3. Type REDO at the command prompt to redo the last undo command.
Command: **REDO**



TIPS:

-UNDO has no effect on some commands and system variables, including those that open, close, or save a window or a drawing, display information, change the graphics display, regenerate the drawing, or export the drawing in a different format.

-REDO must immediately follow the U or UNDO command.

1.12 Function Keys and Accelerator Keys

F1	Displays Help
F2	Toggles Text Window
F3	Toggles OSNAP
F4	Toggles TABMODE
F5	Toggles ISOPLANE
F6	Toggles UCSDETECT
F7	Toggles GRIDMODE
F8	Toggles ORTHOMODE
F9	Toggles SNAPMODE
F10	Toggles Polar Tracking
F11	Toggles Object Snap Tracking
F12	Toggles Dynamic Input

ALT+F11	Displays the Visual Basic Editor
ALT+F8	Displays the Macros dialog box
CTRL+0	Toggles Clean Screen
CTRL+1	Toggles Properties palette
CTRL+2	Toggles DesignCenter
CTRL+3	Toggles the Tool Palettes Window
CTRL+4	Toggles Sheet Set Manager
CTRL+5	Toggles Info Palette
CTRL+6	Toggles dbConnect Manager
CTRL+7	Toggles Markup Set Manager
CTRL+8	Toggles the QuickCalc calculator palette
CTRL+9	Toggles the command window
CTRL+A	Selects objects in drawing
CTRL+SHIFT+A	Toggles Groups
CTRL+B	Toggles Snap
CTRL+C	Copies objects to Clipboard
CTRL+SHIFT+C	Copies objects to Clipboard with Base Point
CTRL+D	Toggles Dynamic UCS
CTRL+E	Cycles through isometric planes
CTRL+F	Toggles running object snaps
CTRL+G	Toggles Grid
CTRL+H	Toggles PICKSTYLE
CTRL+I	Toggles COORDS

CTRL+J	Repeats last command
CTRL+L	Toggles Ortho mode
CTRL+M	Repeats last command
CTRL+N	Creates a new drawing
CTRL+O	Opens existing drawing
CTRL+P	Prints current drawing
CTRL+R	Cycles layout viewports
CTRL+S	Saves current drawing
CTRL+SHIFT+S	Brings up the Save As dialog box
CTRL+T	Toggles Tablet mode
CTRL+V	Pastes data from Clipboard
CTRL+SHIFT+V	Pastes data from Clipboard as a Block
CTRL+X	Cuts objects to Clipboard
CTRL+Y	Cancel the preceding Undo action
CTRL+Z	Reverses last action
CTRL+[Cancel current command
CTRL+\	Cancel current command
CTRL+PAGE UP	Moves to the next layout tab to the left of the current tab
CTRL+PAGE DOWN	Moves to the next layout tab to the right of the current tab

1.13 On-Line Help

1. Choose Help, AutoCAD Help.
or
2. Click the Help icon. 
- or
3. Type HELP at the command prompt
Command: **HELP**
or
4. Press **Function Key F1**

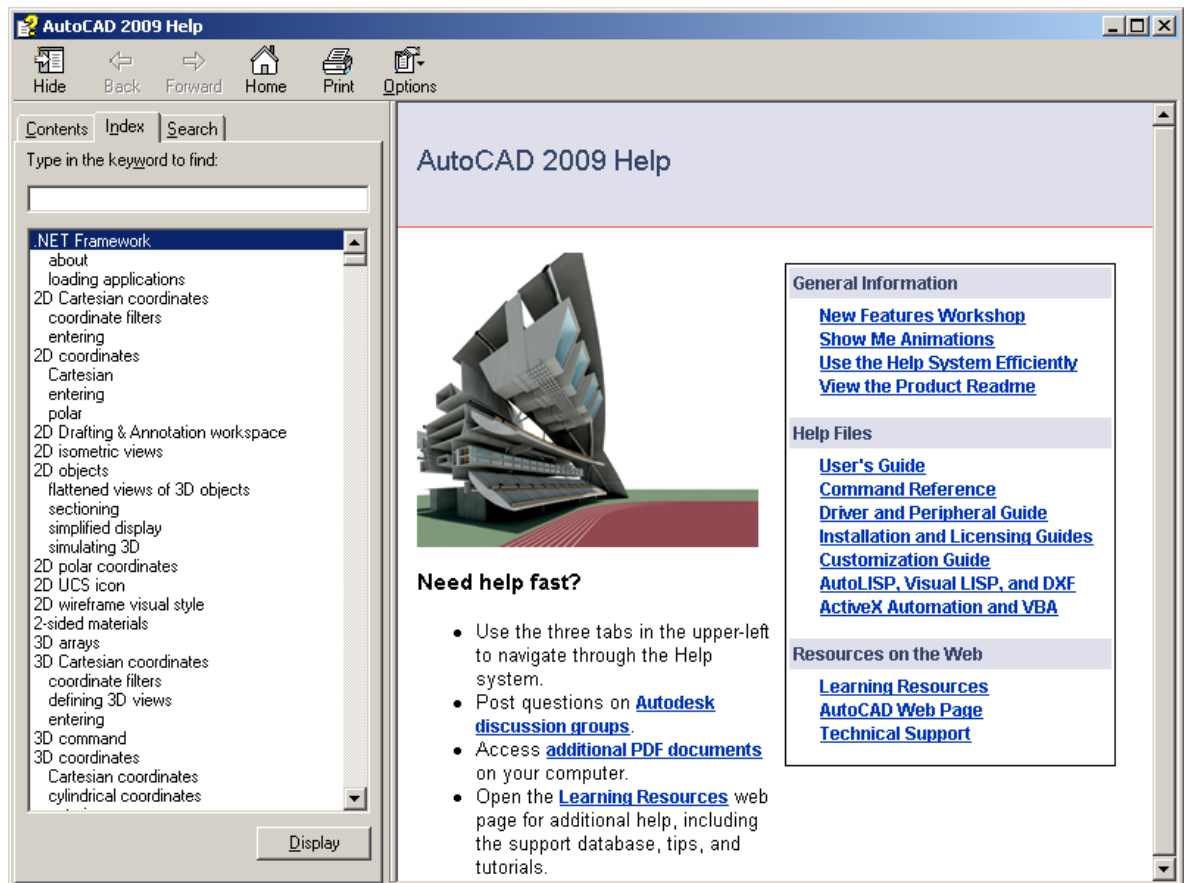

Chapter 2

Introduction to Commands

2.1 Open Existing Drawings

1. **Choose** File, OPEN.
or
2. **Press** CTRL + O.
or
3. **Click** the OPEN icon.
or
4. **Type** OPEN at the command prompt.
Command: **OPEN**
5. **Press** ENTER
6. **Double Click** the desired directory to find the drawing to open.
7. **Click** the drawing name to open.
8. **Click** The OK button.

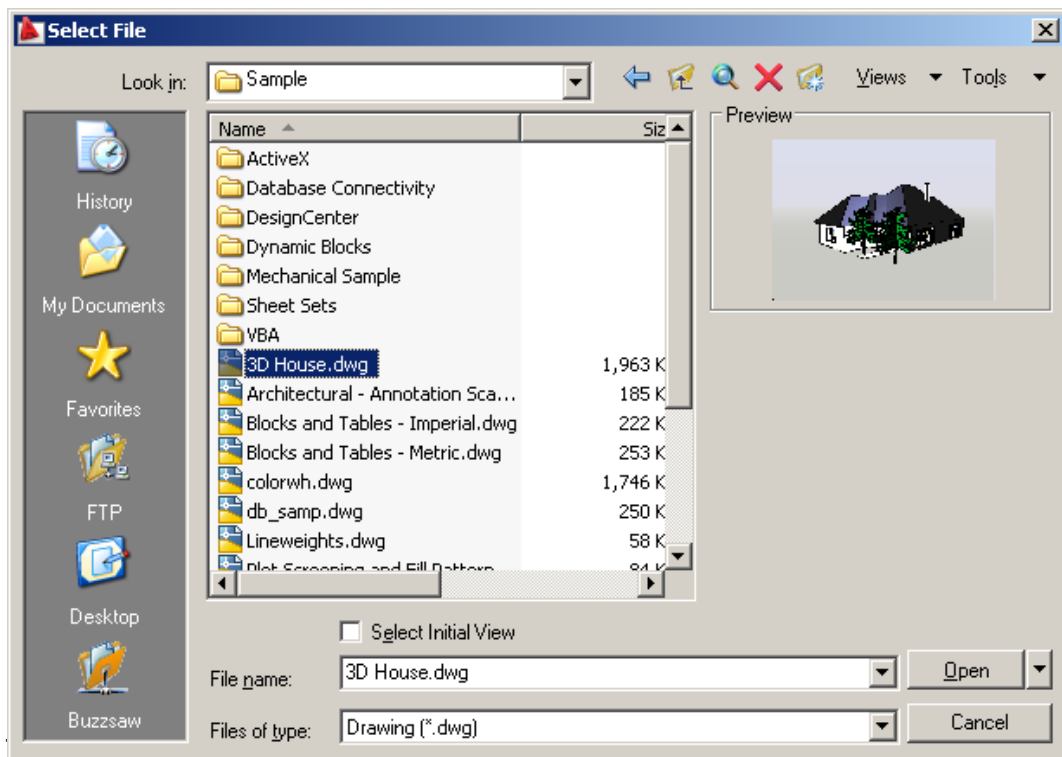

-Preview shows a bitmap image of the drawing selected. This image is the view that was last saved in the drawing. It will not show a preview of drawings saved before R13 AutoCAD.

2.2 Creating a New Drawing

NEW Command

Creates a new drawing file.

1. **Choose** File, New.
or
2. **Press** CTRL + N
or
3. **Click** the New icon.
or
4. **Type** NEW at the Command prompt.
Command: **NEW**
5. **Choose** One of the options for creating a new drawing.
6. **Click** The OK button.
7. **Save** the drawing as another name.

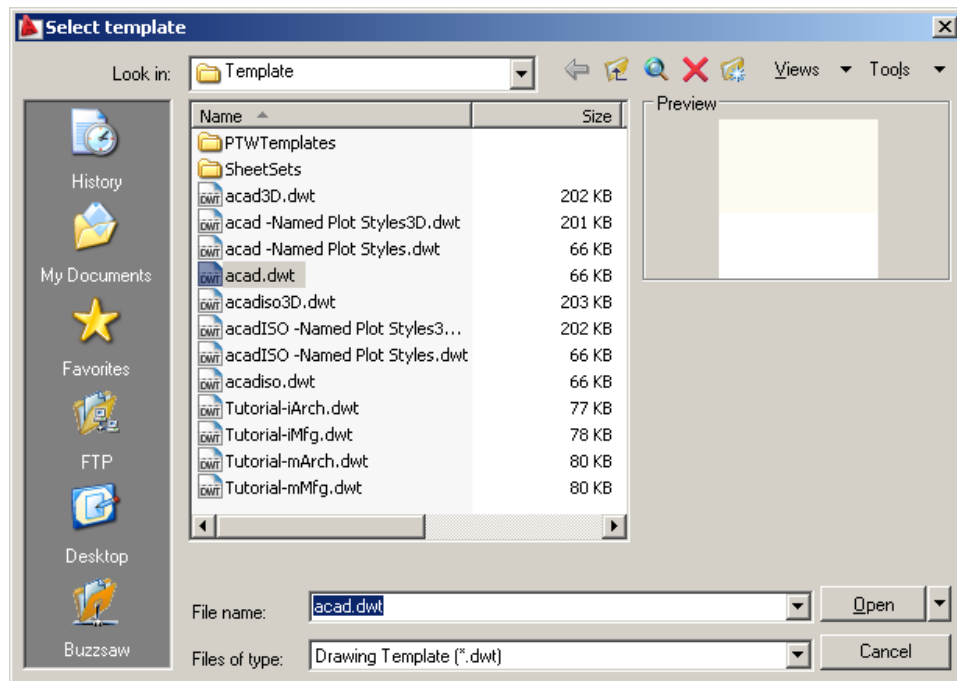

TIP:

New drawings can also be created from Template Files.

2.3 Saving Drawings

Saves the most recent changes to a drawing. The first time an unnamed drawing is saved the "Save As" dialog box appears. AutoCAD saves its drawings as files with extensions ending in .DWG.

1. **Choose** **File, Save or Saveas.**
or
2. **Type** SAVE or SAVEAS at the command prompt.
Command: **SAVE** or **SAVEAS**
3. **Press** **ENTER**
4. **Type** A new drawing name or keep the existing drawing name.
5. **Click** The OK button.

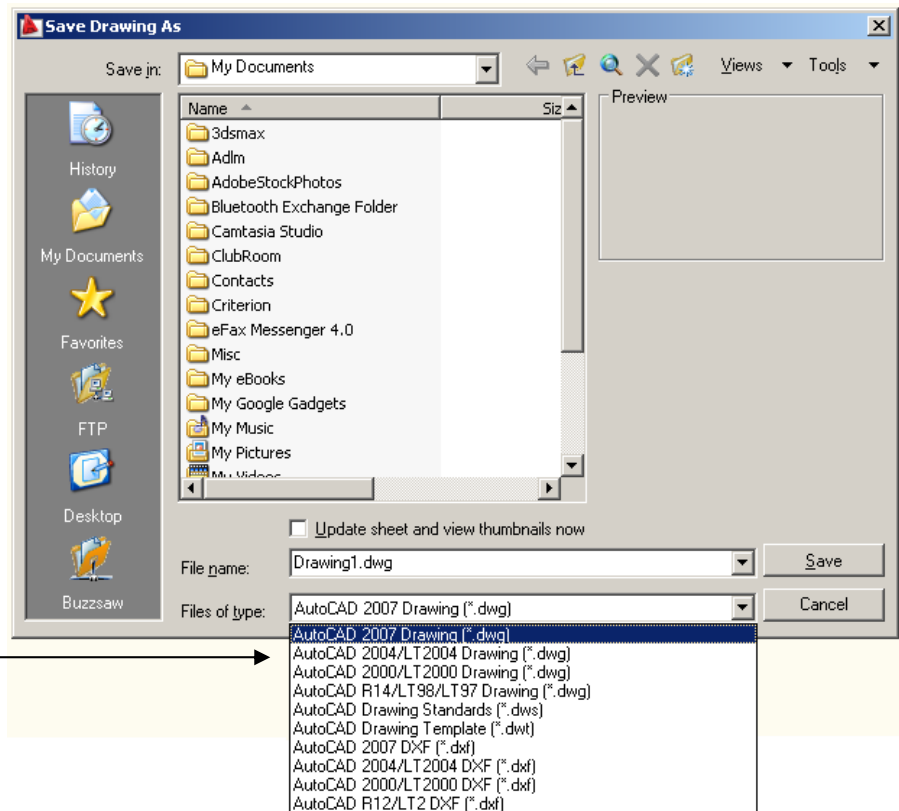

TIP:

Clicking the dropdown list for File type changes the format that the drawing can be saved in.

Quick Save

The QSAVE command is equivalent to clicking Save on the File menu.

If the drawing is named, AutoCAD saves the drawing using the file format specified on the Open and Save tab of the Options dialog box and does not request a file name. If the drawing is unnamed, AutoCAD displays the Save Drawing As dialog box (see SAVEAS) and saves the drawing with the file name and format you specify.

1. **Press** CTRL + S.
or
2. **Click** the Save icon. 
or
3. **Type** QSAVE at the command prompt,
Command:**QSAVE**

TIPS:

Drawings can be saved as different versions of AutoCAD (e.g. R13, R14, R 2000, etc.)

AutoSave settings under Tools, Options...

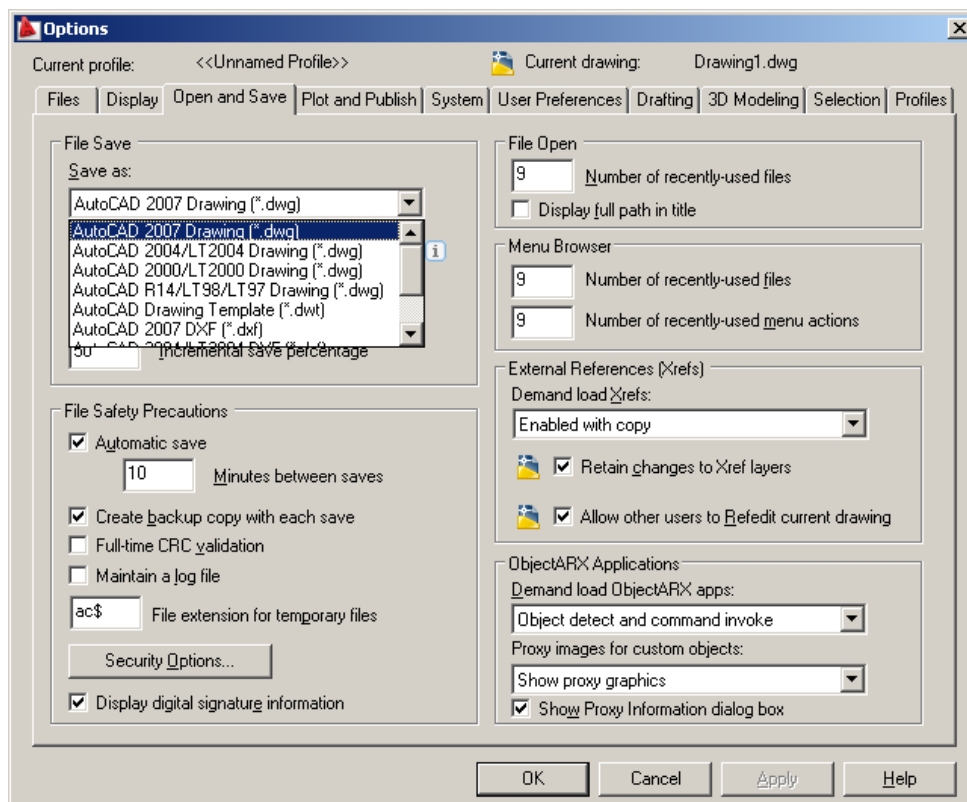

2.4 File Safety Precautions

Autosave

AutoCAD automatically saves information in .SV\$ files; however, users should save their drawings to .DWG files every 10 minutes. A value of zero (0) disables autosave.

Temporary Files

These files have the extensions .ac\$ (temporary drawing file).

After a system failure, if you are on a network, you should not delete temporary files until you have verified that they are not part of an active editing session.

Other temporary files may be left in the drawing directory or the temporary file directory.

AutoSave and SV\$ under Tools, Options..., Open and Save

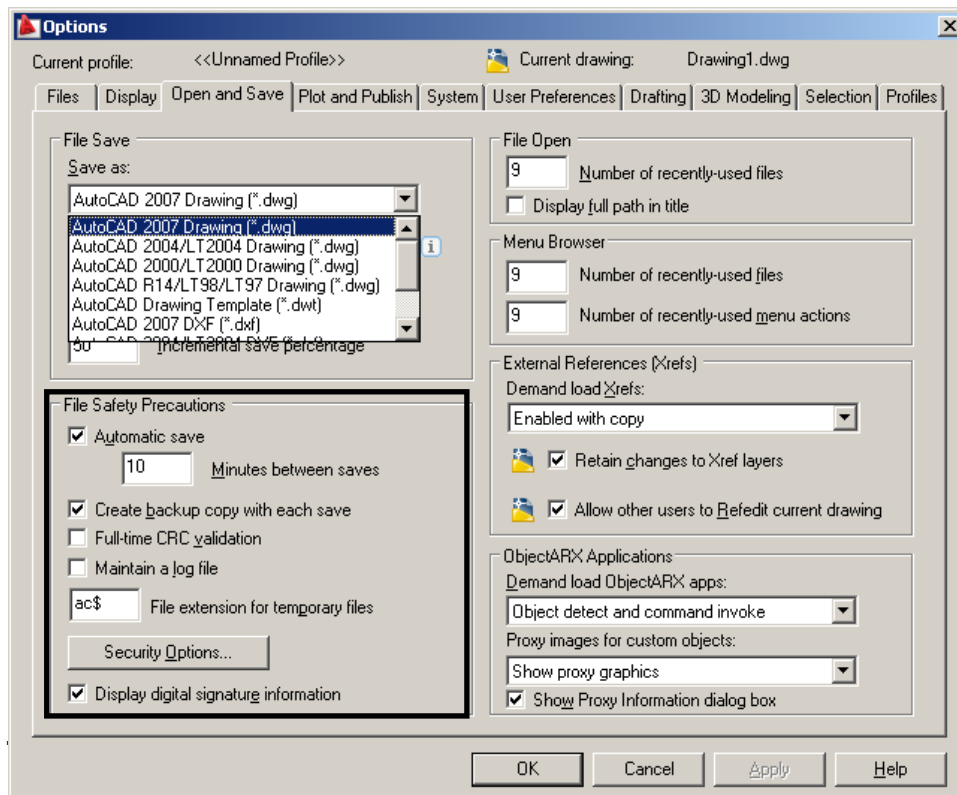

Security Options

Specifies security settings to be used when your drawing is saved. The Password option adds a password to a drawing when it is saved.

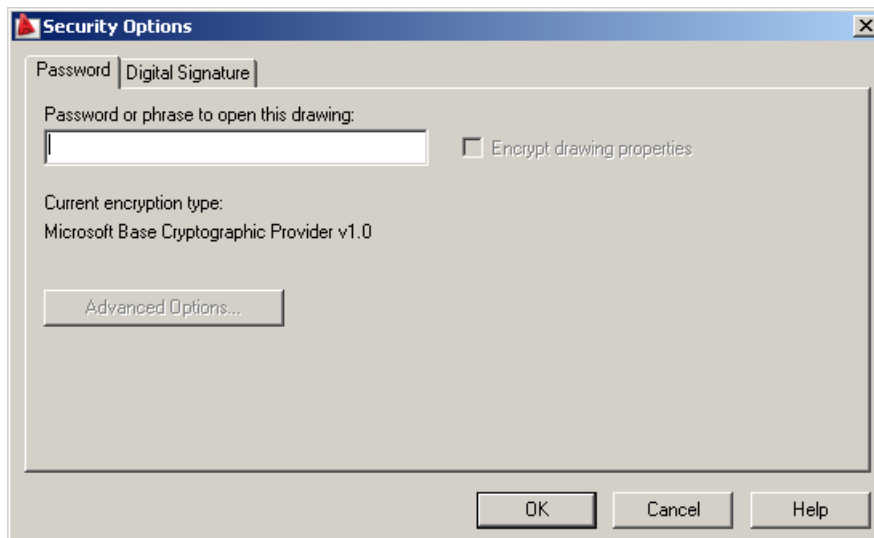
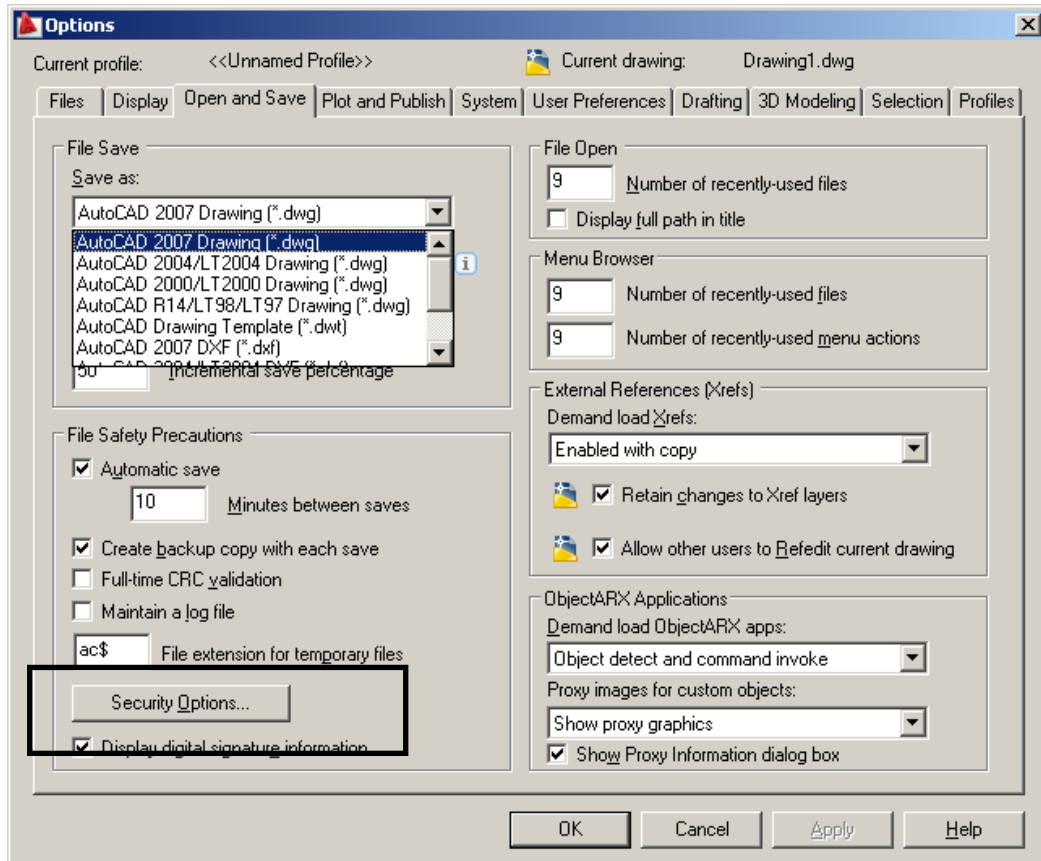

2.5 Exiting AutoCAD

1. **Choose** File, Exit.
or
2. **Type** QUIT at the command prompt.
Command: **QUIT**
3. **Press** ENTER
4. **Click** Yes to save changes or No to discard changes.

Chapter 3

Draw Commands

3.1 Line Command

Creates single straight line segments

1. **Choose** Draw, Line.
or
2. **Click** the Line icon. 
or
3. **Type** LINE from the command prompt
Command: **LINE** or **L**
4. **Press** ENTER
5. **Pick** From point: (**point**)
6. **Pick** Specify next point or [Close/Undo]:(**point**)
7. **Pick** Specify next point or [Close/Undo]:(**point**)
8. **Press** ENTER to end line sequence
or
9. **Type** U to undo the last segment
To point: **U** (undo)
or
10. **Type** C to create a closed polygon
To point : **C** (close)

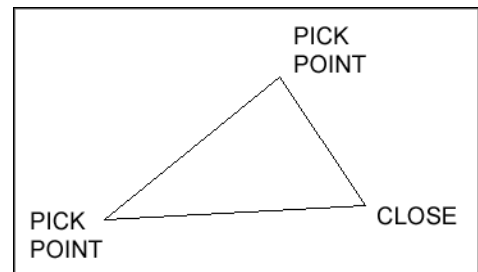

TIPS:

- You can continue the previous line or arc by responding to the From point: prompt with a space or ENTER.
- Choose the right mouse button for the line pop-up menu to appear while in the line command

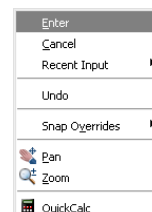

3.2 Cartesian Coordinate System

AutoCAD provides the user with an infinite two dimensional area to work with. Any entities placed on the working two dimensional plane can be defined relative to the Cartesian coordinate system.

The Cartesian coordinate system divides a two dimensional plane with two perpendicular axes. The X axis runs horizontal across the bottom of the screen. The Y axis runs vertically along the left side of the screen. These two axes intersect at the bottom left corner of the screen.

Each of these axes is further divided into segments. Each segment is given a value. The X axis segments increase in value to the right. The positive X values are to the right of the intersection of the two axes. The negative X values are to the left. The positive Y values are above the intersection and increase up. The negative Y values are below.

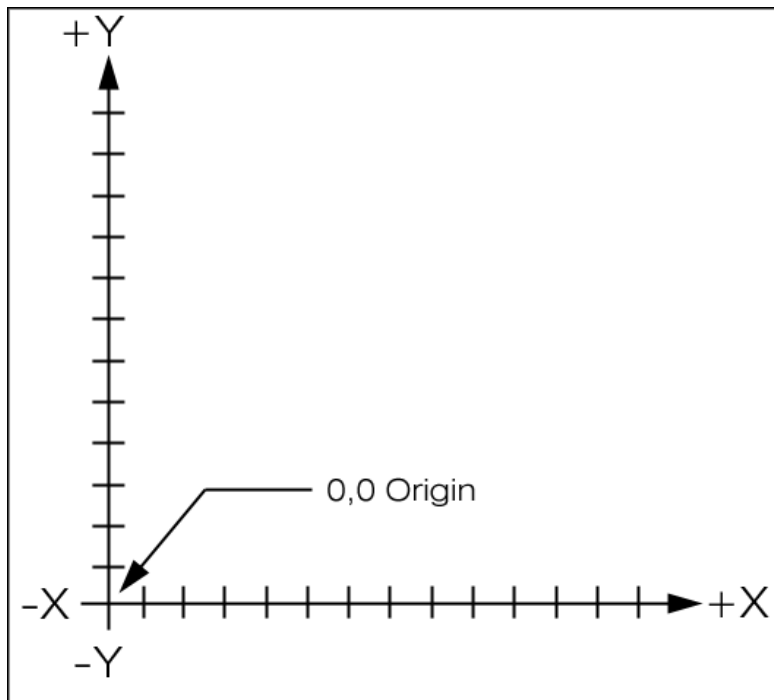

Absolute Coordinates

1. **Type** x,y coordinate when AutoCAD asks for a point.

From point: **1,1**

To point: **2,1**

To point: **2,2**

To point: **1,2**

To point: **1,1**

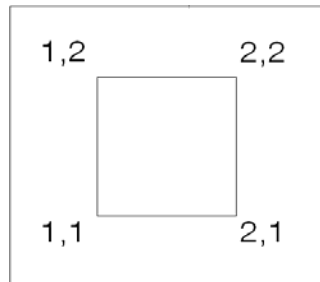

NOTE: If dynamic input (F12) is on, you must type the # sign before entering absolute coordinates (e.g.#1,1).

Relative Coordinates

1. **Type** @deltax,deltay when AutoCAD asks for a point.

From point pick point

To point: **@1,0**

To point: **@0,1**

To point: **@-1,0**

To point: **@0,-1**

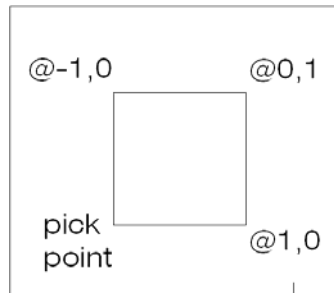

Polar Coordinates

1. **Type** @distance<angle when AutoCAD asks for a point.

From point: pick point

To point: **@1<0**

To point: **@1<90**

To point: **@1<180**

To point: **@1<270**

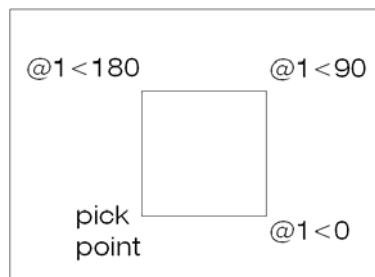

3.3 Dynamic Input

Dynamic Input provides a command interface near the cursor to help you keep your focus in the drafting area.

When Dynamic Input is on, tooltips display information near the cursor that is dynamically updated as the cursor moves. When a command is active, the tooltips provide a place for user entry.

Turning Dynamic Input ON/OFF

1. Click **Dyn** on the status bar
or
2. Press **F12**

Tip: Right-click Dyn and click Settings to control what is displayed by each component when Dynamic Input is on.

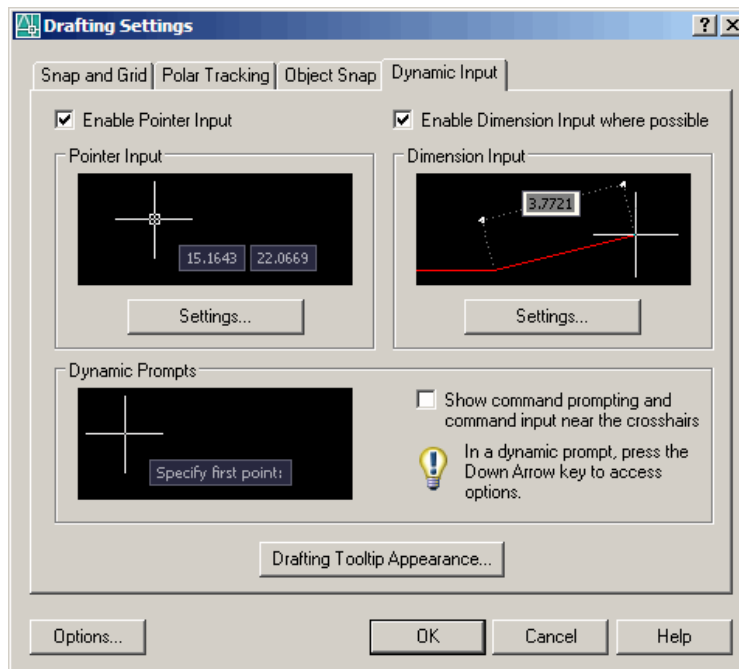

3.4 Orthogonal Lines

Controls lines from being drawn at various angles to straight lines. When the snap grid is rotated, ortho mode rotates accordingly.

1. **Press** Function Key **F8**.
or
2. **Double Click** ORTHO from the Status Bar.
or
3. **Press** CTRL + L.

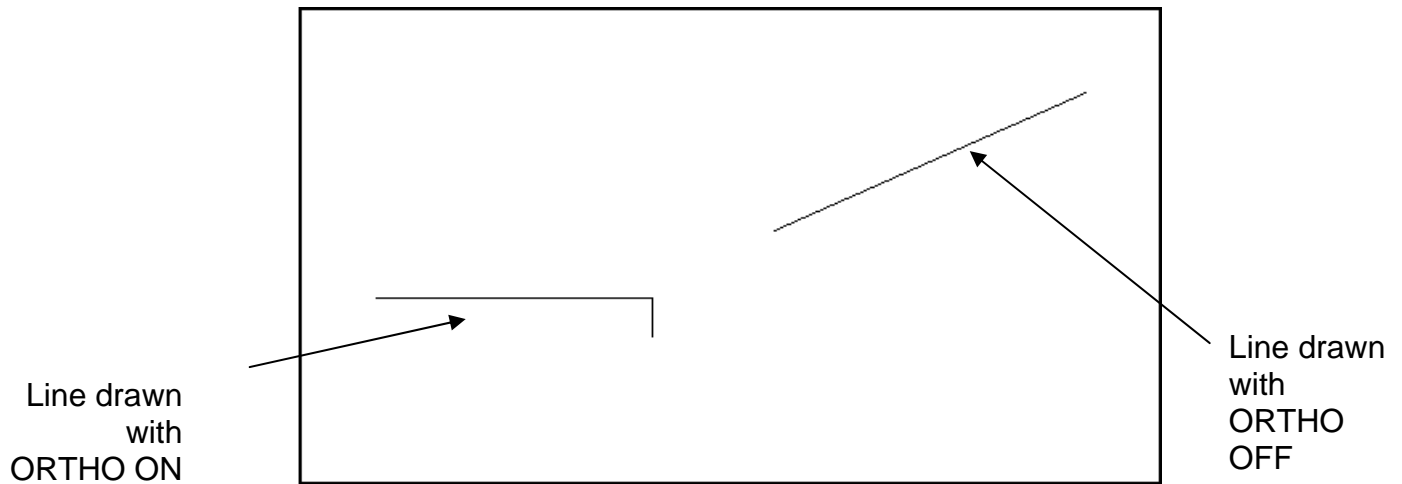

3.5 Polar Tracking

Polar Snaps work independently from snaps. With Polar Snaps on, AutoCAD shows the distances and angles being displayed as the cursor moves.

1. **Choose** Tools, Drafting Settings
or
2. **Type** DDSETTINGS at the command prompt.
Command : **DDESTTINGS**
3. **Choose** the Polar trackingTAB from the dialog box.
4. **Select** the desired incremental angle from the dropdown list (or create a new angle).

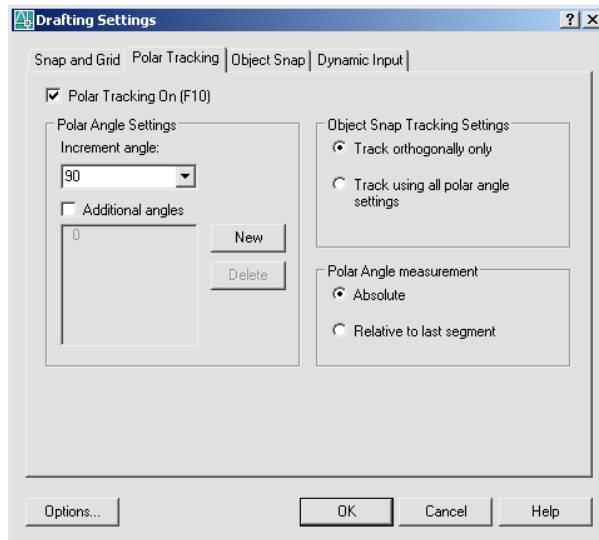

5. **Pick** OK to exit the dialog box.
6. **Draw** a LINE using the Polar Snap references.

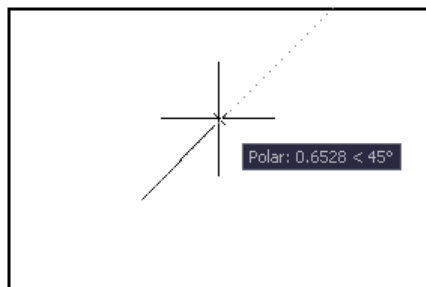

3.6 Circles

Circle Command

1. **Choose** Draw, Circle.
or
2. **Click** the Circle icon. 
- or
3. **Type** CIRCLE at the command prompt.
Command: **CIRCLE**
4. **Type** One of the following options:
3P/2P/TTR/⟨⟨center point⟩⟩:
or
5. **Pick** A center point.
6. **Type** A radius or diameter.
or
7. **Pick** A radius or diameter
Diameter/⟨⟨radius⟩⟩:

Circle, Center Radius

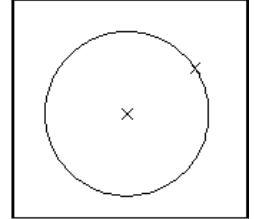

Circle, Center Diameter

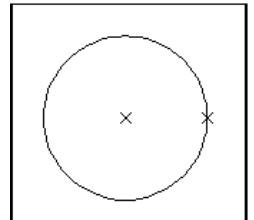

Circle, Tangent, Tangent Radius

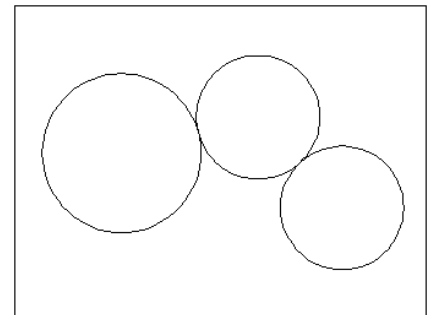

Circle, Tangent, Tangent, Tangent

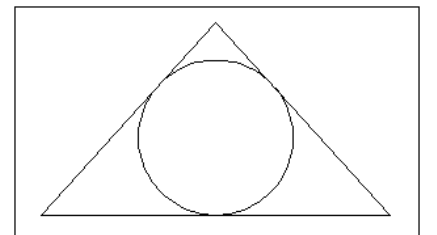

TIPS:

- To create circles that are the same size, press ENTER when asked for the circle radius.
- When selecting a circle with a pickbox, be sure to select the circumference of the circle.

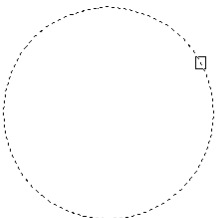

3.7 Arc Command

1. **Choose** Draw, Arc.
or
2. **Click** the Arc icon. 
- or
3. **Type** ARC at the command prompt
Command: **ARC**
4. **Draw** One of the arcs.

TIPS:

-Except for 3 point arcs, arcs are drawn in a COUNTERCLOCKWISE direction.

- While in the arc command, press the right mouse button to select the following options for arcs:

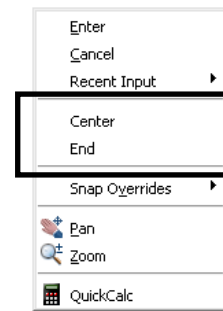

Arc Examples

3 point arc

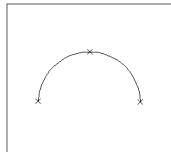

Start ,center, chord length

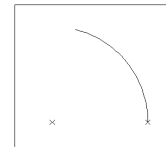

start, center, end



Start, end, radius

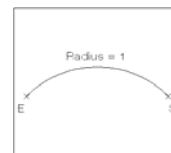

Start , center, included angle

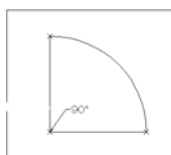

Start, end, direction

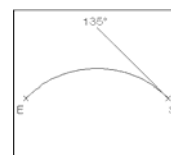

Chapter 4

Erase and Selection Sets

4.1 Erase and Selection Sets

Erasing Objects

1. **Choose** Modify, Erase.
or
2. **Click** the Erase icon. 
or
3. **Type** ERASE at the command prompt.
Command : **ERASE** or **E**
4. **Pick** Object at the select object prompt.
Select objects: (**pick object**)
5. **Press** ENTER when you are done choosing objects.
Select objects: **ENTER**

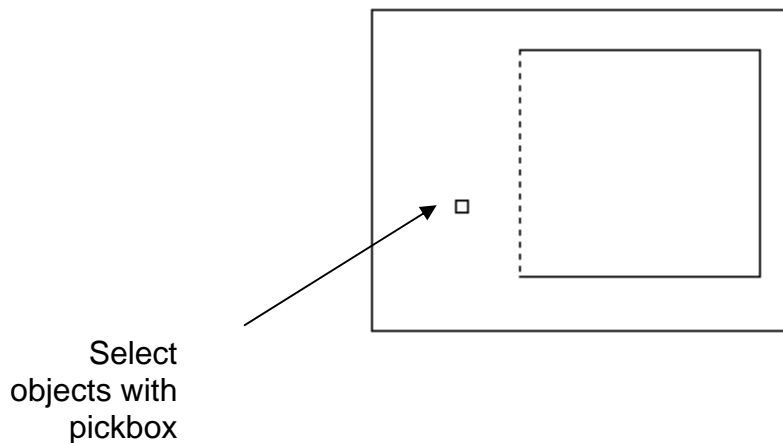

TIP:

- If the cursor is not touching an object, AutoCAD will create a crossing or window selection as defined on the following pages.

4.2 Selection Set Options

Type one of the following options at the Select objects: prompt: (point)One object.

ALL	All objects within the drawing are selected unless they are on frozen or locked layers.
Multiple	Multiple objects selected without high lighting (faster edits).
Last	Last object.
Previous	All objects in the previous selection-set.
Group	Objects in a named group.
AUto	Automatic BOX (if pick in empty area).
Single	One selection (any type).
Add	Add mode: adds following objects to selection-set.
Remove	Remove mode: removes following objects from selection-set.

Window and Crossing

Window
Objects fully enclosed within Window.

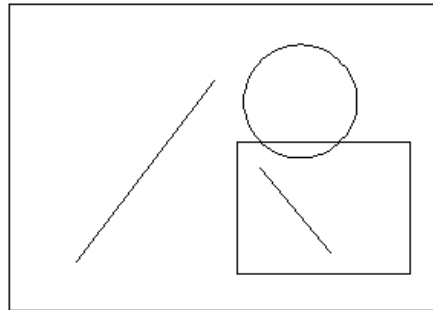

Crossing
Objects within or Crossing a window.

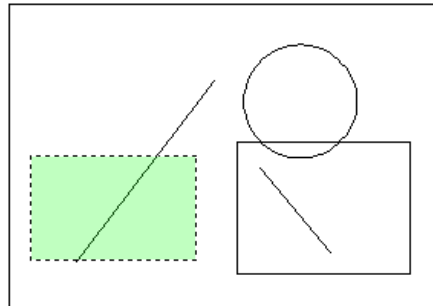

WPolygon

All entities within the boundaries of a polygon created by inputted points.

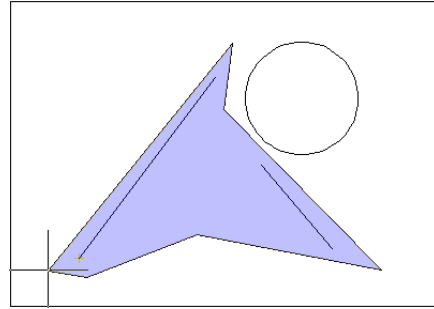

CPolygon

All entities within or touching the boundaries of a polygon created by input.

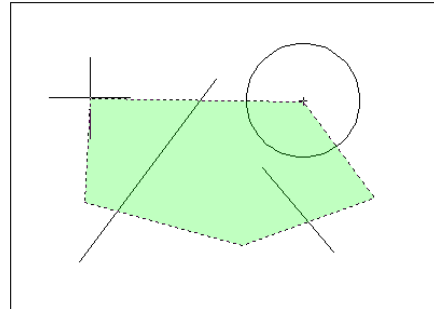

Fence

Objects that are crossed by a temporary line.

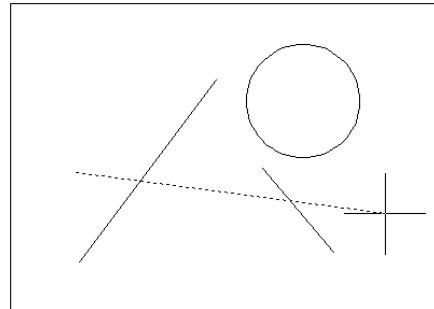

Remove from Selection Set

1. **Press** **SHIFT** and select entities to remove them from the selection set.

4.3 OOPS

Reinserts the last erased set of objects or block even if it was not the last command issued. Otherwise Oops acts like UNDO.

1. **Type** OOPS at the command prompt to reinsert erased objects
Command: **OOPS**

4.4 Selection Preview

SELECTIONPREVIEW

Controls the display of selection previewing

Chapter 5

Basic Display Commands

5.1 ZOOM

Increases or decreases the apparent size of objects in the current viewport

1. **Choose** View, Zoom.
or
2. **Click** a Zoom icon. 
3. **Type** ZOOM at the command prompt.
Command: **Zoom** or **Z**
4. **Type** One of the following zoom options:

The following are basic zoom options:

- All** Places entire drawing (all visible layers) on display at once. Forces a regeneration.
- Extents** Displays current drawing content as large as possible.
- Previous** Restores previous view.
- Window** Designates rectangular area to be drawn as large as possible.
- Number** Magnification relative to ZOOM All display
- Number X** Magnification relative to current display (1X)
- Center** Specifies center point and new display height.
- Dynamic** Permits you to pan a box representing the viewing screen around the entire generated portion of the drawing and enlarge or shrink it.

TIPS:

-While in the ZOOM command, click with the right mouse button to see the menu to the right.

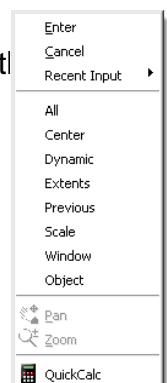

5.2 PAN

Shifts the location of a view.

1. **Choose** View, Pan.

or

2. **Click** the Pan icon. 

or

3. **Type** PAN from the command prompt.

Command: **PAN** or **P**

TIPS:

- While in the PAN command, click with the right mouse button to see the following menu.

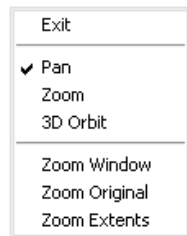

- Panning can also be done by using the window scroll bars

5.3 Redraw and Regen

Redraw refreshes the current view.

1. **Type** Redraw at the command prompt
Command: **Redraw** or **R**

REGEN regenerates the entire drawing and recomputes the screen coordinates for all objects. It also re-indexes the drawing database for optimum display and object selection performance.

1. **Type** REGEN at the command prompt.
Command: **REGEN** or **RE**

TIP: When BLIPMODE is on, marker blips left by editing commands are removed from the current viewport

Blips showing

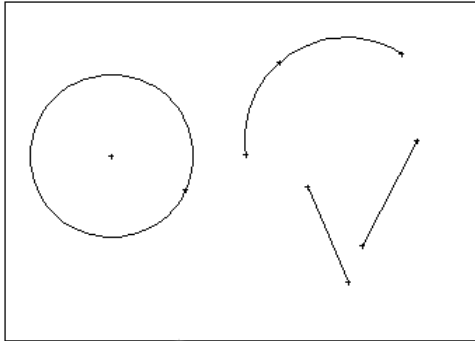

Blips removed after redraw

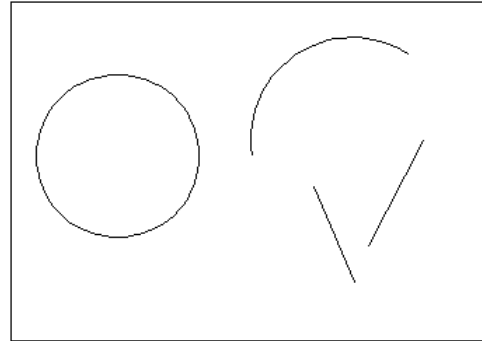

5.4 Blipmode

Controls the display of marker blips. When Blip mode is on, a temporary mark in the shape of a plus sign (+) appears where points are specified. BLIPMODE is off by default.

1. **Type** BLIPMODE at the command prompt.
Command: **BLIPMODE**

Chapter 6

Drawing Aids

6.1 SNAP Command

1. **Choose** Tools, Drafting Settings...
or
2. **Type** SNAP at the command prompt.
Command: **SNAP or SN**
3. **Type** One of the following options: Snap spacing or [ON/OFF/Aspect/Style/Type]:

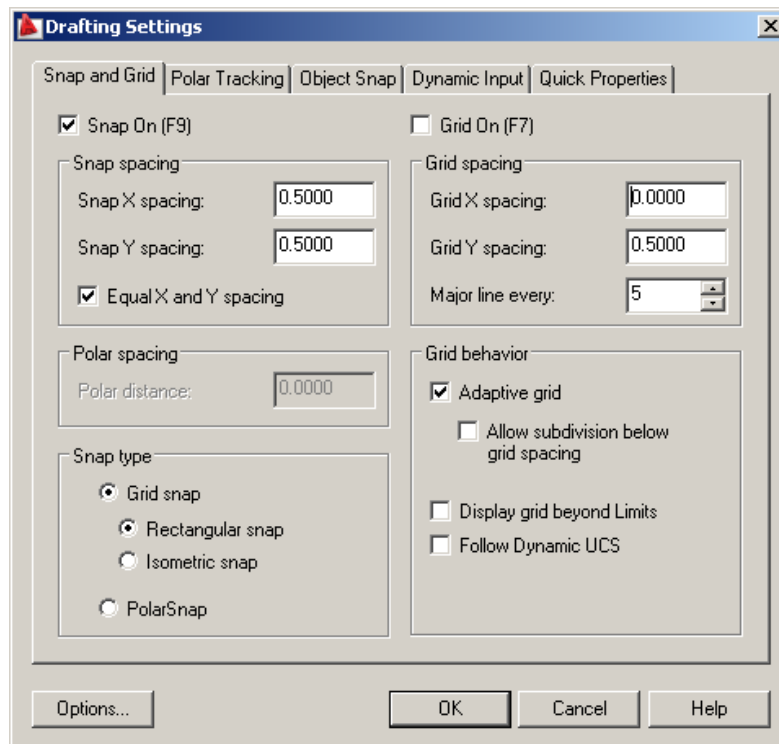

Turn Snap On/OFF

1. **Press** Function Key **F9** to turn the snap ON/OFF.
or
2. **Double Click** SNAP on the Status Bar.
or
3. **Press** CTRL + B.

TIP:

Click with the right mouse button on the SNAP option from the status bar as a shortcut to changing the snap settings.

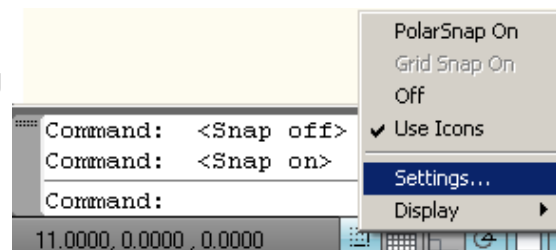

6.2 Grid Command

1. **Choose** Tools, Drafting Settings...
or
2. **Type** DSETTINGS at the command prompt.
Command : DSETTINGS (DS)
or
3. **Type** GRID at the command prompt.
Command: **GRID**
4. **Type** One of the following options:
Grid spacing(X) or ON/OFF/Snap/Aspect
<0000>:

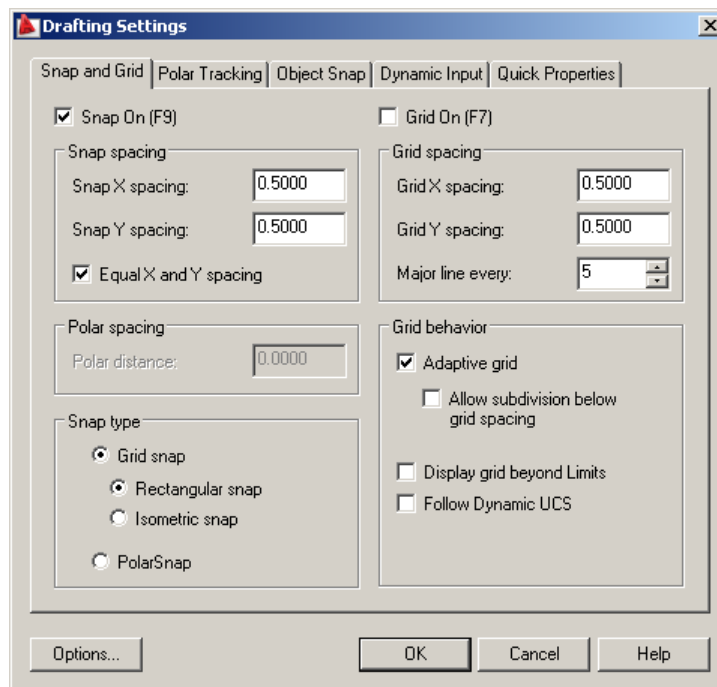

Turn Grid On/Off

1. **Press** Function Key **F7** to turn the grid ON/OFF.
or
2. **Double Click** GRID on the Status Bar.
or
3. **Press** CTRL + G.

7.1 Running Object Snaps

An object snap mode specifies a snap point at an exact location on an object. OSNAP specifies running object snap modes, which remain active until you turn them off.

1. **Choose** Tools, Drafting Settings...
or
2. **Type** DDOSNAP at the command prompt
Command: **DDOSNAP**
or
3. **Click** OSNAP on the Status Bar.
4. **Right Click** the Object Snap TAB.
5. **Choose** an object snap to turn ON/OFF from the dialog box.

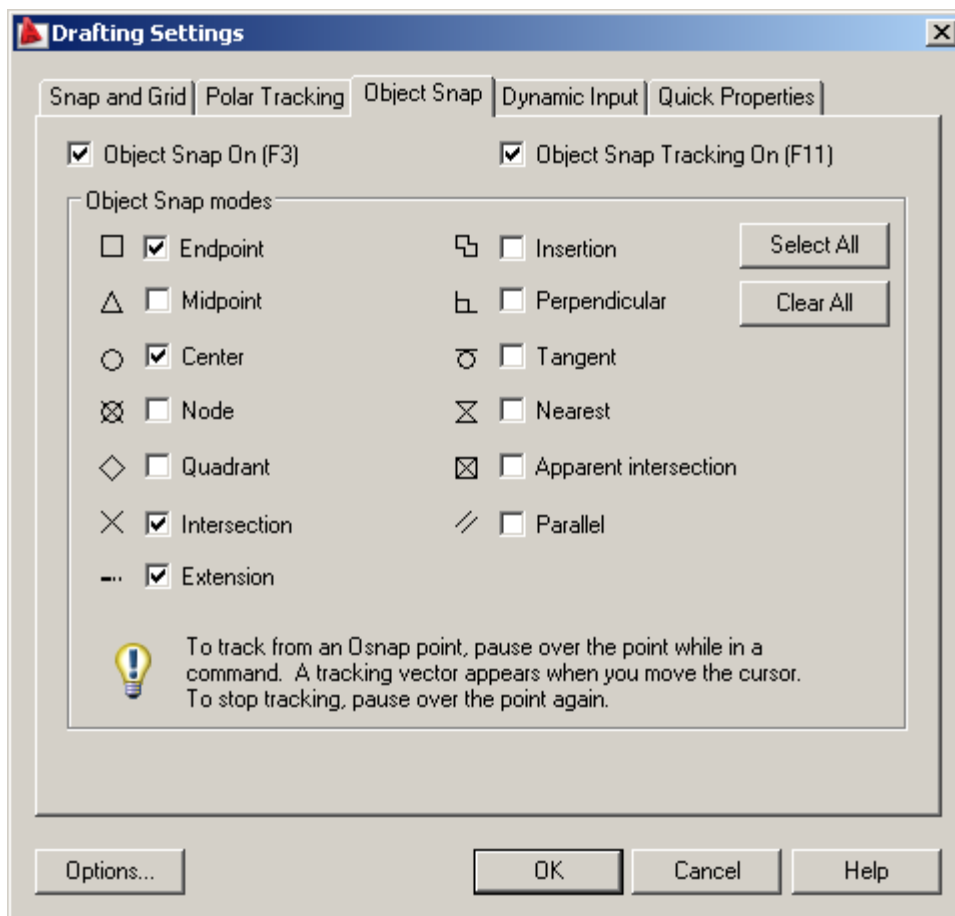

7.2 Case by Case (Temporary Mode)

1. **Press** SHIFT + the RIGHT MOUSE BUTTON.

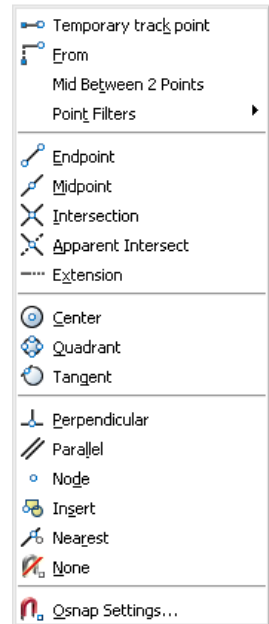

or

2. **Click** one of the object snaps located Object Snap toolbar icon.



or

3. **Type** The object snap at the prompt line.
Command: Line
From pt: **ENDP**
To pt: **MID**
To pt: **CEN**

TIP:

Case by Case objects snaps will override running mode object snaps

7.3 Osnap Settings

When you use any of the object snap settings, AutoSnap displays a marker and a Snap tip when you move the cursor over a snap point.

1. **Choose** Tools, Options...
2. **Select** the Drafting tab in the Options dialog box.
3. **Change** settings and choose OK.

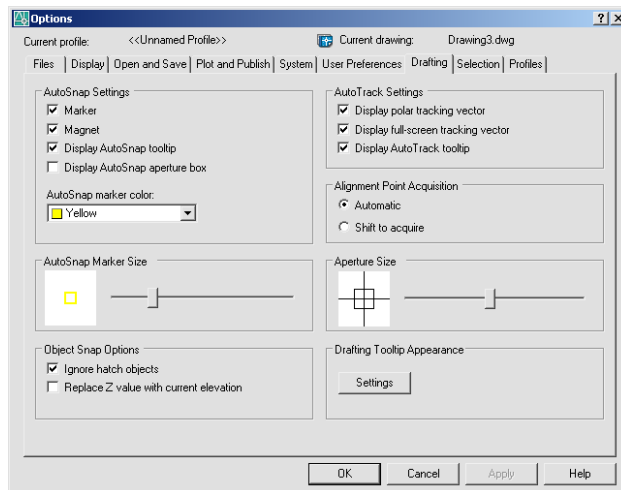

The following are object snap modes:

CEN ter	Center of Arc or Circle
END point	Closest endpoint of Line/Arc
INS ertion	Insertion point of Text/Block/Shape/ Attribute
INT ersection	Intersection of Lines/Arcs/Circles
MID point	Midpoint of a line/Arc or midpoint
NEA erst	Nearest point on a Line/Arc/Circle/Point
APP arent Int	Finds where two entities would intersect
NOD e	Nearest point entity (or Dimension defini tion point)
NON e	None (off)
PER pendicular	Perpendicular to a Line/Arc/Circle
QUA drant	Quadrant point on an Arc/Circle
QUI ck	Quick mode (first find, not closest)
TAN gent	Tangent to Arc or Circle

7.4 Aperture

Controls the size and appearance of the pickbox used for object snap selection.

1. **Type** APERTURE at the command prompt
Command: **APERTURE**
2. **Type** The size of the target box (3-8 is a good size)
Size of target box in pixels (1-50): (**number**)

or

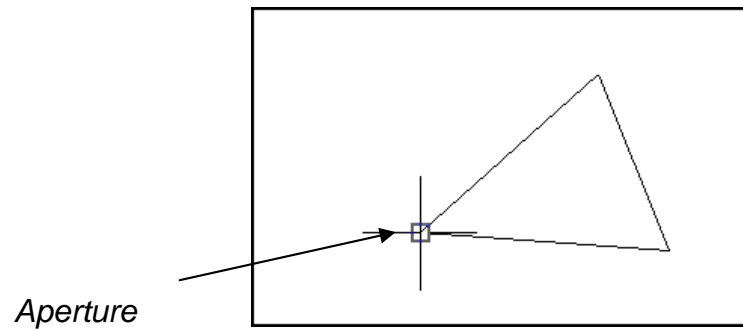

Chapter 8
Setting Up a Drawing

AutoCAD 2D Tutorial

List Command 8.1

1. **Choose** Tools, Inquiry, List.
or
2. **Click** the List icon from the Inquiry Toolbar. 
- or**
3. **Type** LIST at the command prompt.
Command: **LIST** or **LI**
4. **Pick** The object or objects to list.
Select objects: (**select**)
5. **Press** ENTER when you are finished choosing objects:

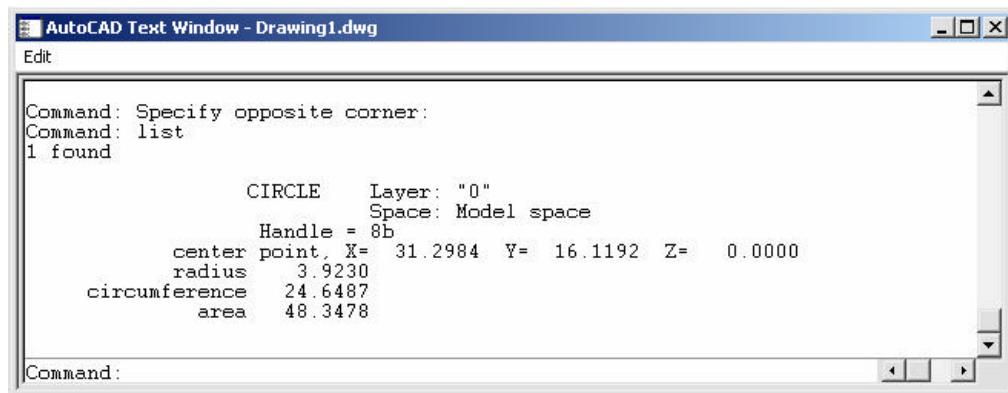

```
AutoCAD Text Window - Drawing1.dwg
Edit
Command: Specify opposite corner:
Command: list
1 found

          CIRCLE   Layer: "0"
                   Space: Model space
                   Handle = 8b
center point, X= 31.2984 Y= 16.1192 Z= 0.0000
radius         3.9230
circumference  24.6487
area           48.3478

Command:
```

AutoCAD 2D Tutorial

Measuring Distances 8.2

1. **Choose** Tools, Inquiry, Distance.
or
2. **Click** the Distance icon from the Inquiry Toolbar. 
- or**
3. **Type** DIST at the command prompt
Command: **DIST**
4. **Pick** The first point to measure from
First point: **pick point**
5. **Pick** The second point to measure to
Second point: **pick point**

Distance Between Circle Centers

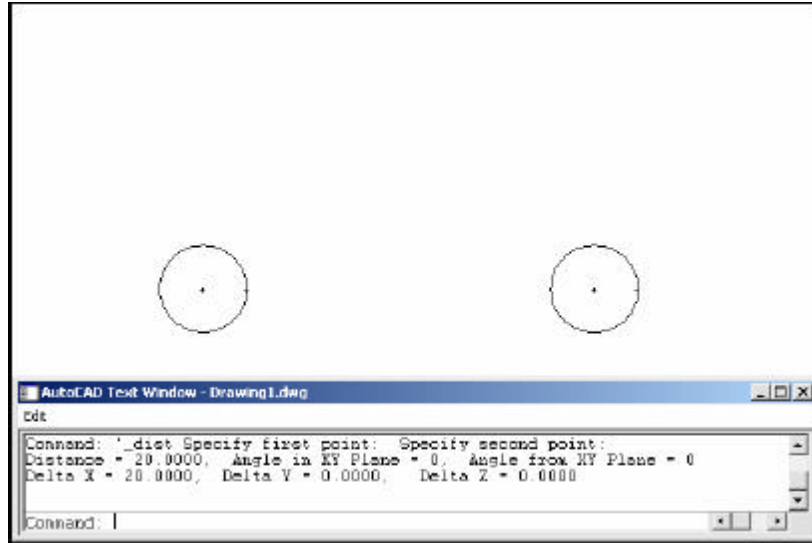

TIP:

Be sure to use Object Snaps with the MEASURE command.

AutoCAD 2D Tutorial

Calculating Areas 8.3

1. **Choose** Tools, Inquiry, Area.
or
2. **Click** the Area icon. 
- or
3. **Type** AREA at the command prompt
Command: **AREA**
4. **Pick** The first point for area calculation
<First point>/Object/Add/Subtract: **pick**
5. **Pick** Next point: **pick**
6. **Pick** Next point: **pick**
7. **Press** ENTER when you are finished choosing points.
Area of Rectangle

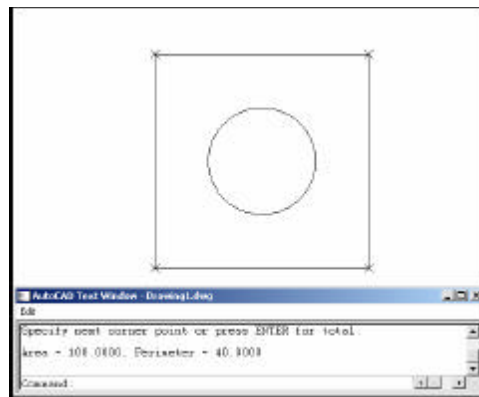

- Object** Allows user to pick an object to calculate area (circle or polyline).
- Add** Adds separate areas for a total area calculation
- Subtract** Subtracts areas from each other.

TIPS:

Be sure to use Object Snaps with the MEASURE command

To subtract an area, you must first be in “add” mode to add the first area.

AutoCAD 2D Tutorial

ID Command 8.4

1. **Choose** Edit, Inquiry, Locate Point.

or

2. **Click** the Locate Point Icon from the Inquiry Toolbar.



or

3. **Type** ID at the command prompt.

Command: **ID**

4. **Pick** A point to identify

Point : **pick point**

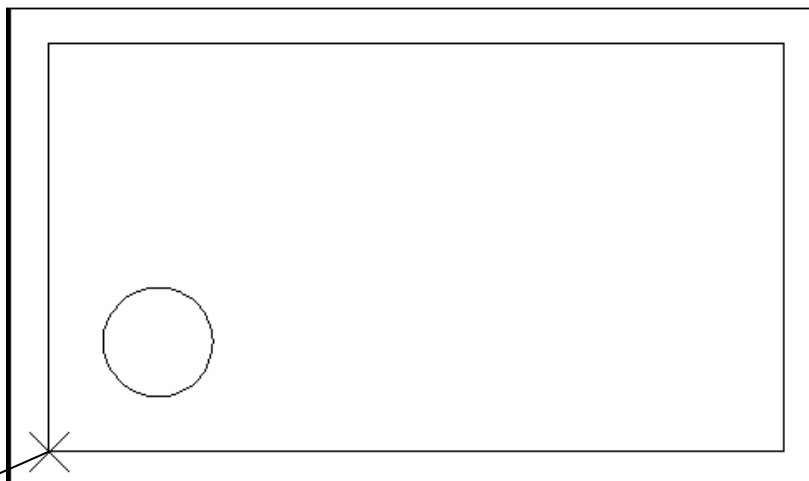

Using ID at the corner of the box rests the "0,0" origin for relative coordinates

TIP:

AutoCAD returns the X,Y, and Z coordinates as well as making this the last point entered in the drawing (to move relative from)

Be sure to use Object Snaps with the ID command.

AutoCAD 2D Tutorial

UNITS Command 8.5

1. **Choose** Format, Units...
or
2. **Type** DDUNITS at the command prompt.
Command: **DDUNITS** or **UN**
3. **Choose** a units and angle setting.
4. **Choose** a precision setting.

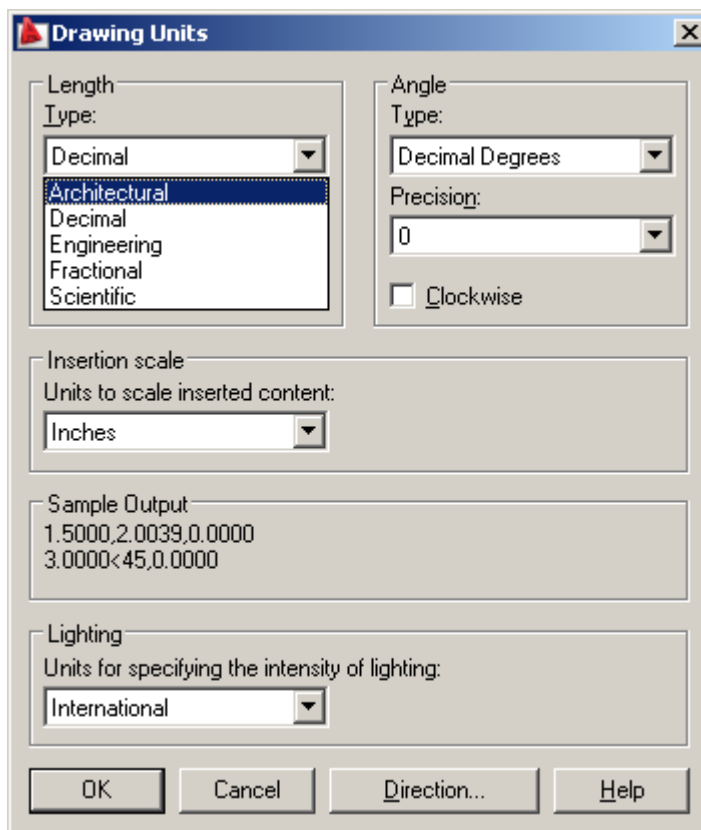

AutoCAD 2D Tutorial

Drawing Limits 8.6

The drawing limits are two-dimensional points in the World Coordinate System that represent a lower-left limit and an upper-right limit.

The drawing limits also govern the portion of the drawing covered by the visible grid and determine the minimum area a ZOOM All displays.

1. **Choose** Format, Drawing Limits.
or
2. **Type** LIMITS at the command prompt
Command: **LIMITS**
3. **Type** One of the following options
On/Off/Lower left corner <.000,0.000>: **0,0**
4. **Type** One of the following options for the
upper right limit:
Upper right corner <12.0000,9.0000>:**36,24**

Drawing with lower left limit of 0,0 and upper right limit of 36,24



TIPS:

You can also pick points to define the limits.

The limcheck variable controls whether or not you can draw outside the limits that are set. A setting of 0 (off) indicates that you can draw outside the limits and a setting of 1 (on) indicates that you cannot.

AutoCAD 2D Tutorial

Plot Scales and Paper Sizes 8.7

The following is an example of setting up an AutoCAD drawing for a D size sheet of paper (36 x24) with a scale of 1/16=1').

1. **Size** the object you're drawing.
2. **Border Size** 36 x 24 plotted, 576' x 384' drawn.
For some plotters, deduct a 1/2 margin on top, bottom, and left, and a 1 margin on the right.
3. **Limits** Lower left limit 0,0.
Upper right limit 576', 384'.
4. **Text Height** for 1/8 notes, multiply by 192 which is the reciprocal of the plot scale.
1/8 plotted, 24" drawn.
5. **Hatch Scale** for patterns other than architectural.
Hatch Scale = 192
6. **Dimension Scale** Dimscale = 192
7. **Ltscale** Lt scale = 96

Determine your object size

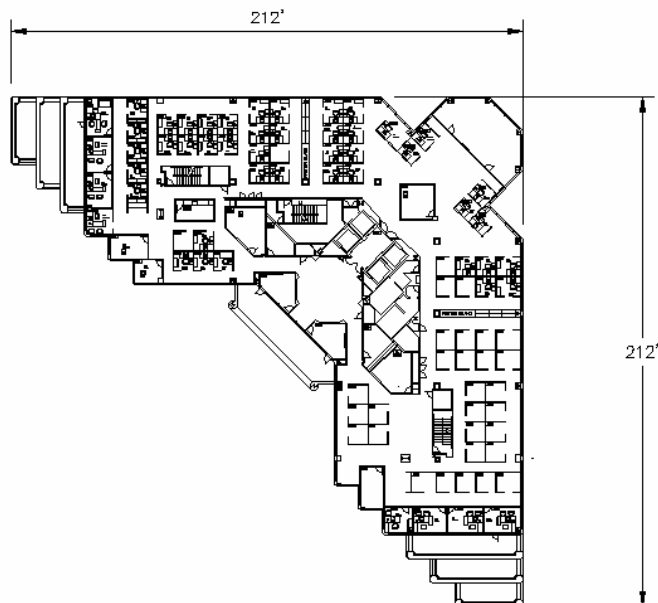

AutoCAD 2D Tutorial

Decide Border (Paper) Size

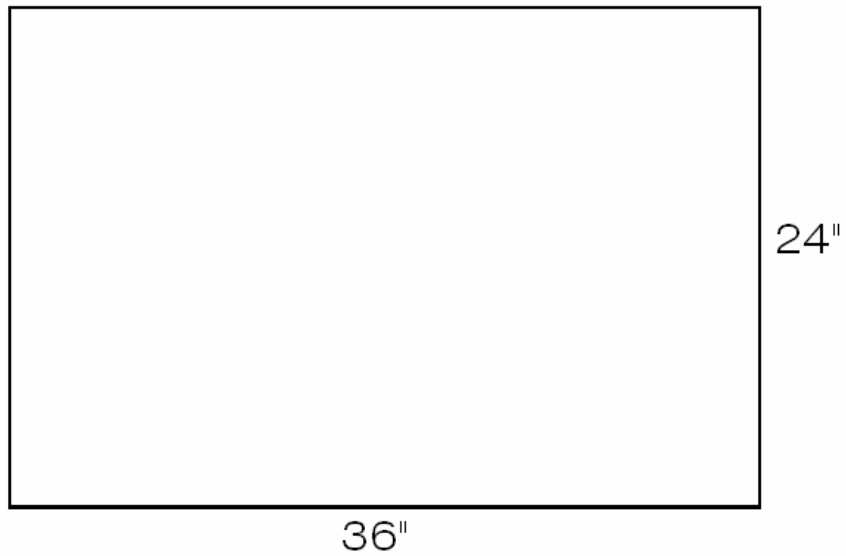

Decide the Scale Factor for Object which is at least 212', 212'. To do this, multiply the scale factor x paper size. (i.e.: 1/16"=1'-0' has scale factor 192)

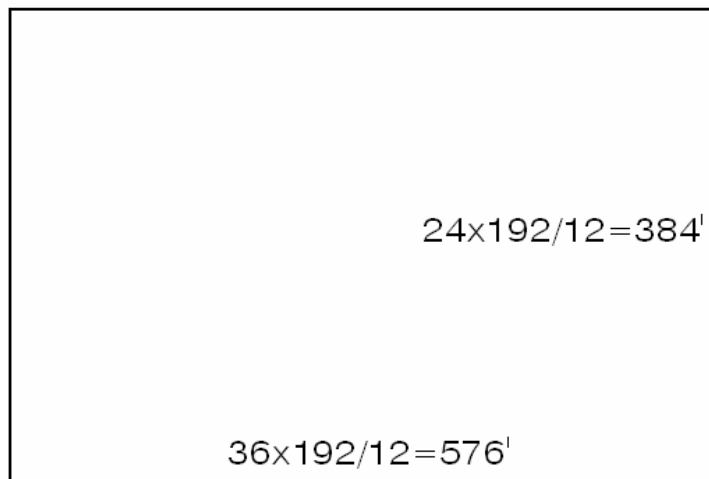

AutoCAD 2D Tutorial

Set Drawing Limits

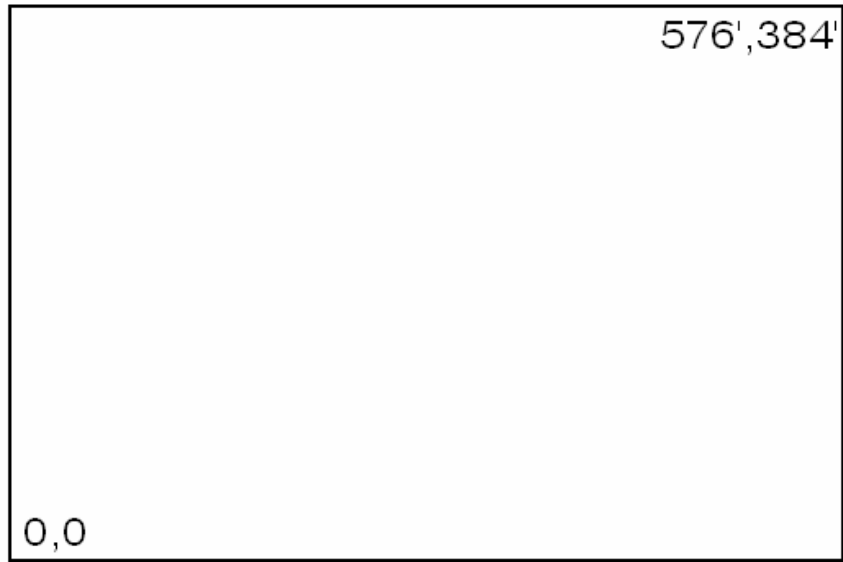

Determine Dim Scale, Hatch Scale, Lt scale, and Text Height

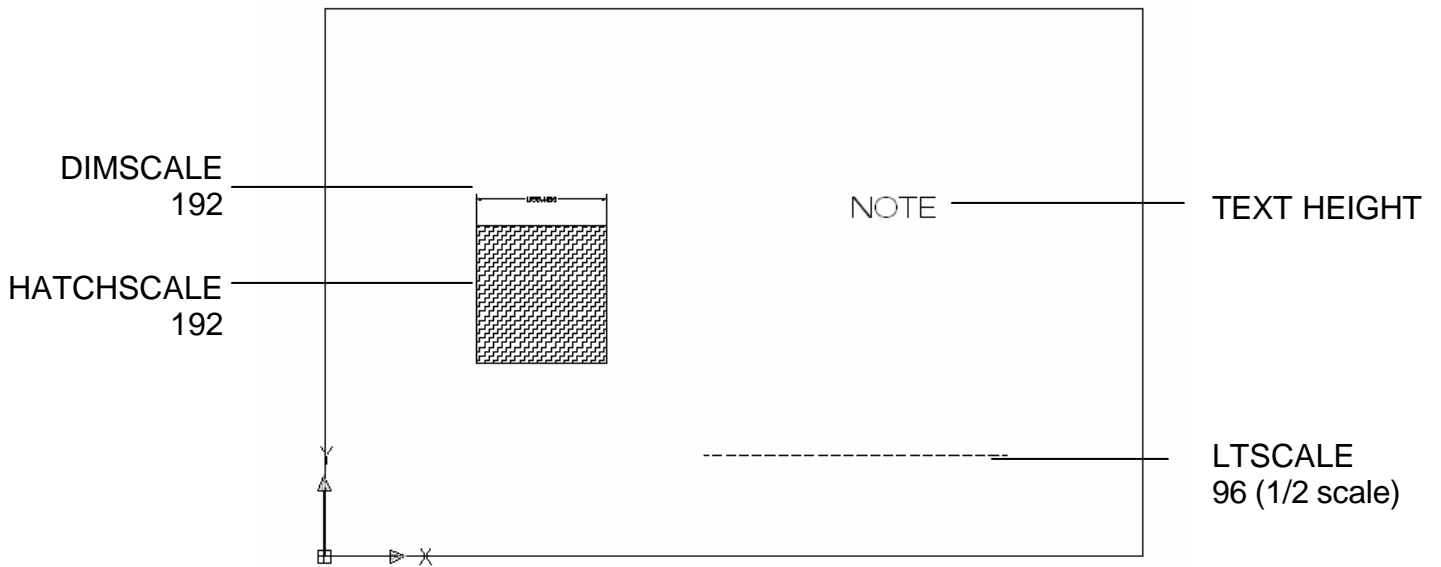

Chapter 9 Plotting

AutoCAD 2D Tutorial

Plot Command 9.1

1. **Choose** File, Plot.
or
2. **Click** the Plotter icon. 
or
3. **Type** PLOT at the command prompt.
Command: **PLOT** or **PRINT**
or
4. **Press** CTRL + P

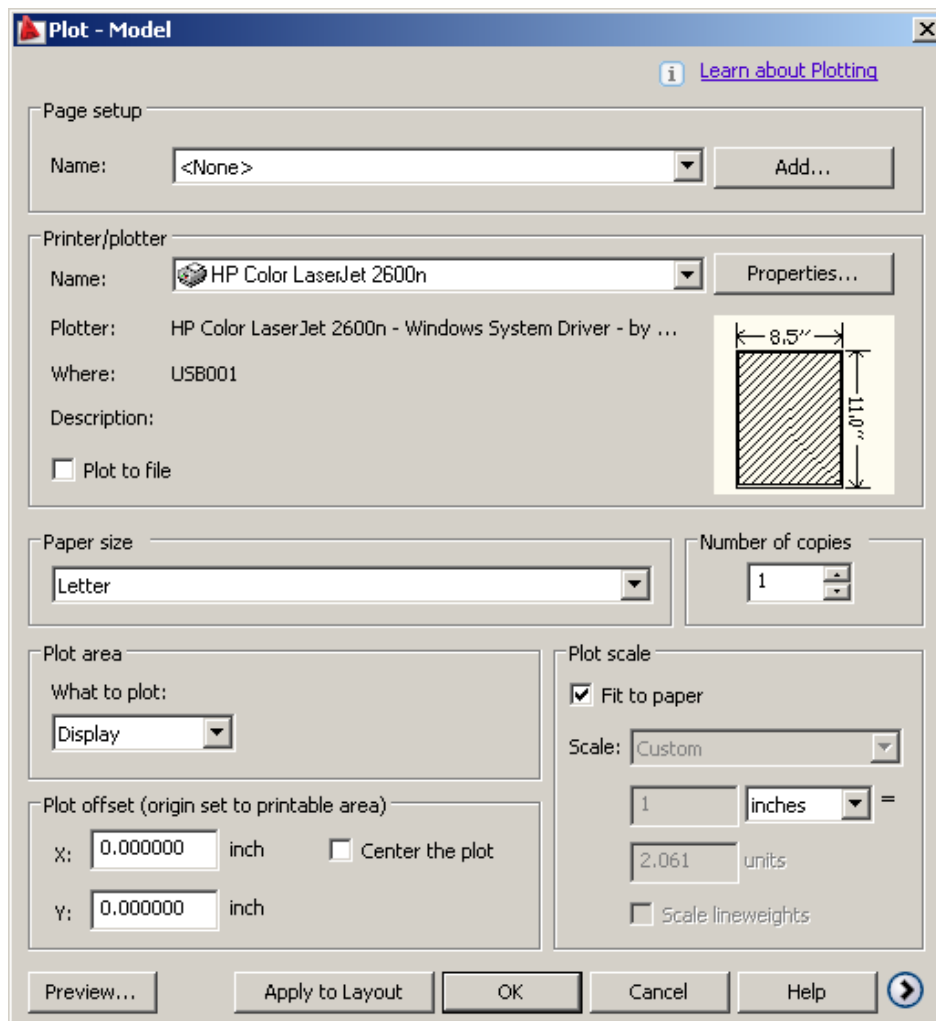

AutoCAD 2D Tutorial

Plot Settings

1. **Choose** the Plot Settings tab.
2. **Choose** the appropriate paper size based on the chosen plotter.
3. **Choose** the paper units (inches or mm).
4. **Choose** the drawing orientation (Portrait, Landscape, Upside down).
5. **Choose** the plotting area.
6. **Choose** the plot scale.
7. **Choose** plot to center or specify an x or y offset.
8. **Click** OK.

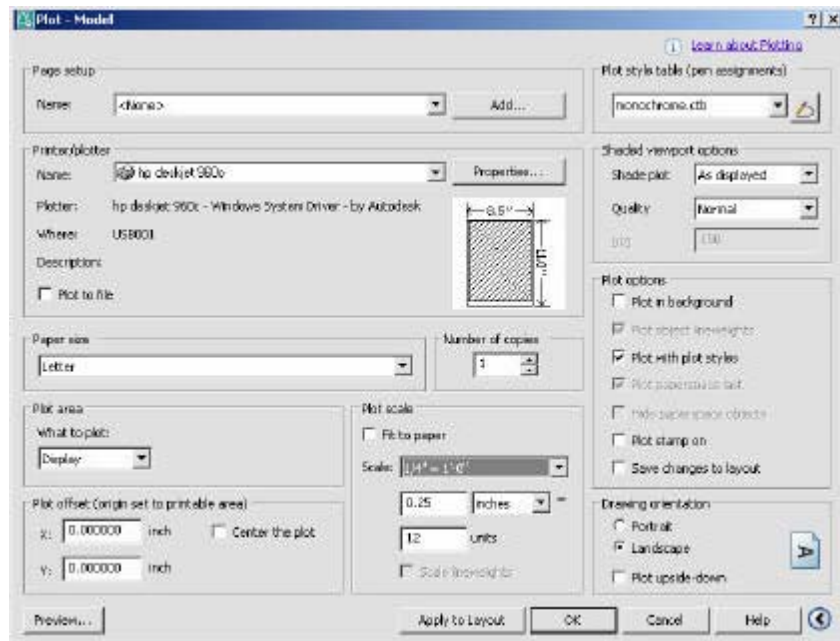

AutoCAD 2D Tutorial

Adding a Plotter 9.2

Plotter Manager Wizard

1. **Choose** File, Plotter Manager
2. **Double-Click** the Add a Plotter Wizard icon.

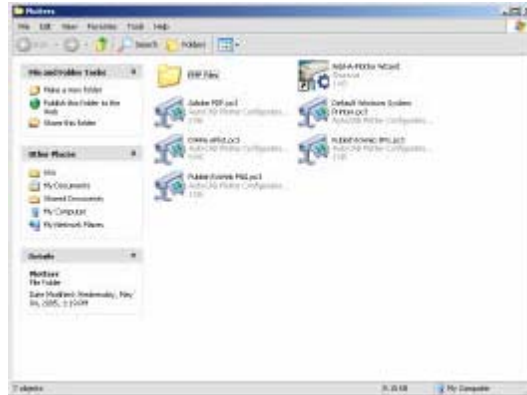

AutoCAD adds a plotter configuration to a saved plot file called ?.PC3. You can then load from this file later.

3. **Click** Next >
4. **Choose** My Computer.

My Computer will configure a plotter using Autodesk Drivers. *System Printer* will configure AutoCAD using Window's printer drivers that are already installed.



5. **Click** Next >

AutoCAD 2D Tutorial

Choosing a Plotter Driver

6. **Choose** one of the Autodesk Plotter options.

Your purchased plotter should be listed here. If it is not, you can choose “Have Disk...” and specify a location for a plotter driver.

You can also plot to a file by choosing the DXB, Autodesk ePlot, or Raster File options.

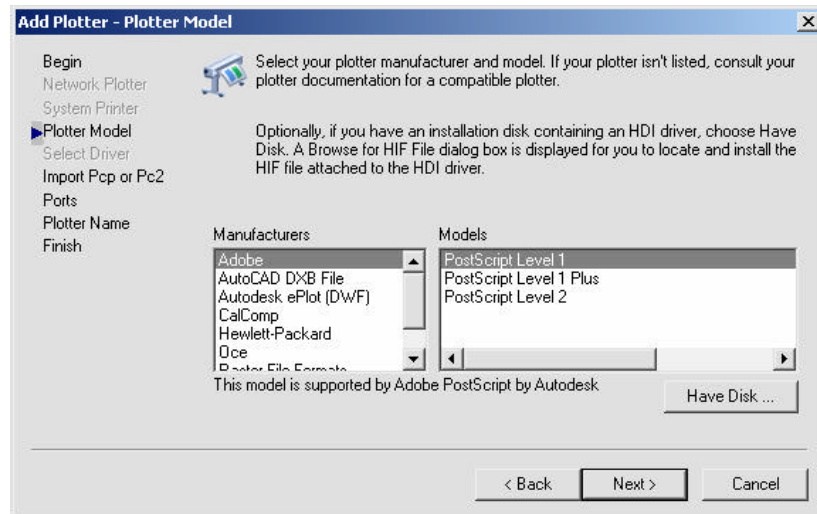

Importing a .PCP or .PC2 file

7. **Choose** Import File...if you wish to import a previously saved plot configuration file.
8. **Click** Next >

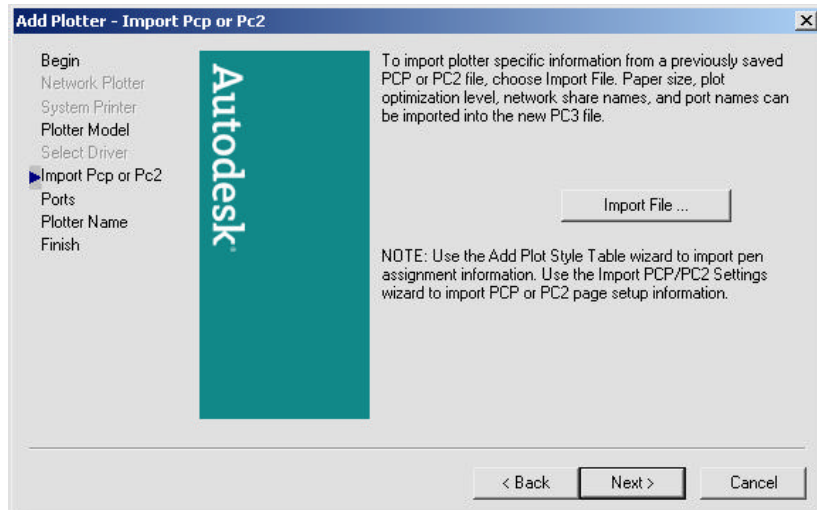

AutoCAD 2D Tutorial

Define a Port

9. **Choose** an available port.
NOTE: You can plot to a specific file name or "Autospool" to a file which can be automatically sent to the plotter at a later date.
10. **Choose** Next >

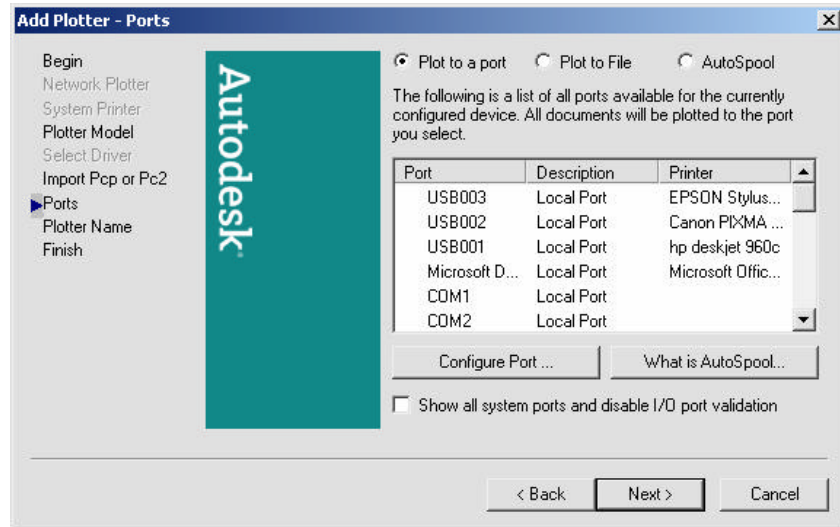

Saving a Plot Configuration Name

11. **Type** the file name you wish to save.
12. **Choose** Next >
13. **Click** Finish

AutoCAD will save a new Plot configuration icon.



DWF6 ePlot.pc3

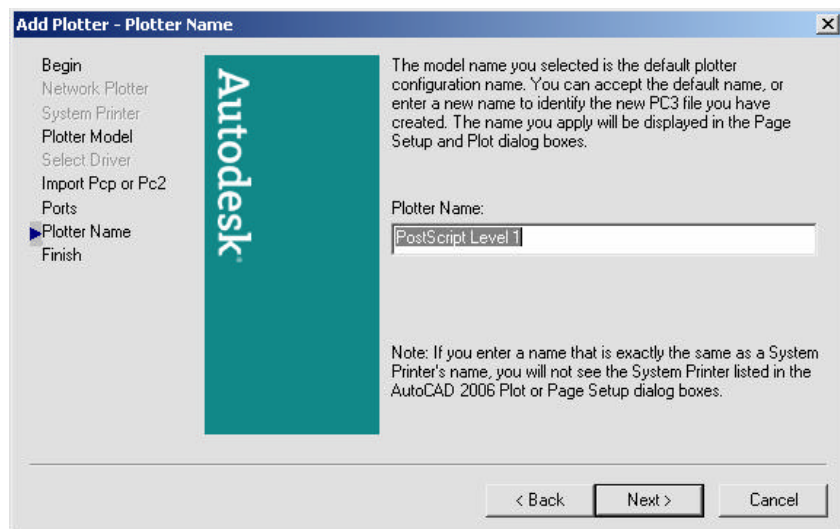

AutoCAD 2D Tutorial

Plot Styles 9.3

Add a Plot Style

A plot style controls how an object or layer is plotted by determining plotted properties such as lineweight, color, and fill style. Plot style tables collect groups of plot styles. The Plot Style Table Manager is a window that shows all the plot style tables available in AutoCAD.

There are two plot style types: color-dependent and named. A drawing can only use one type of plot style table. You can convert a plot style table from one type to the other. You can also change the type of plot style table a drawing uses once it has been set.

1. **Choose** File, Plot Style Manager.
2. **Double-Click** Add a Plot Style Table Wizard icon.



3. **Click** Next >
4. **Choose** Start from Scratch to create a new Plot Style.

You can also use a previously configured plot style, import a style from a previous release of AutoCAD, or import a pen table.

5. **Click** Next >

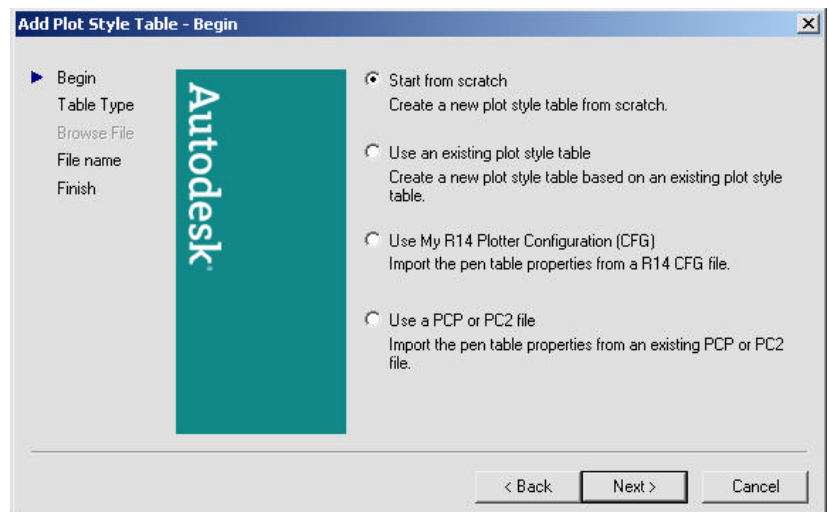

AutoCAD 2D Tutorial

6. **Choose** Color-Dependent Plot Style Table
7. **Click** Next >

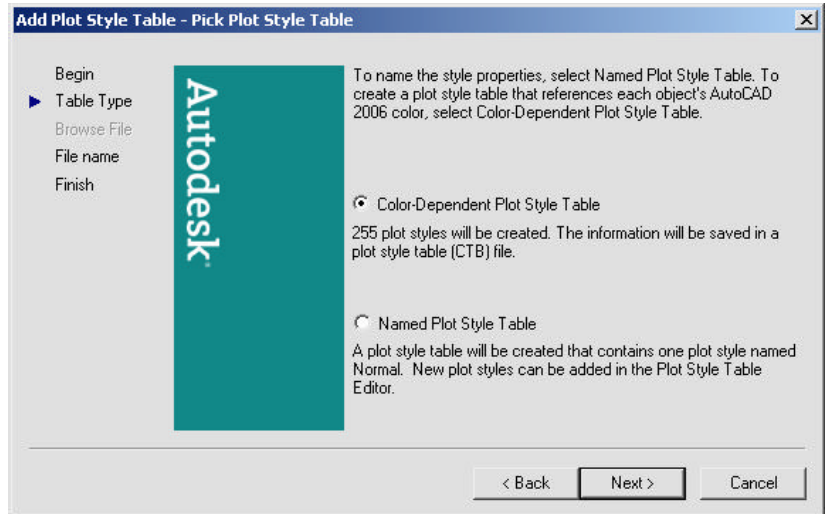

8. **Type** a name for the plot style table.
9. **Click** Next>

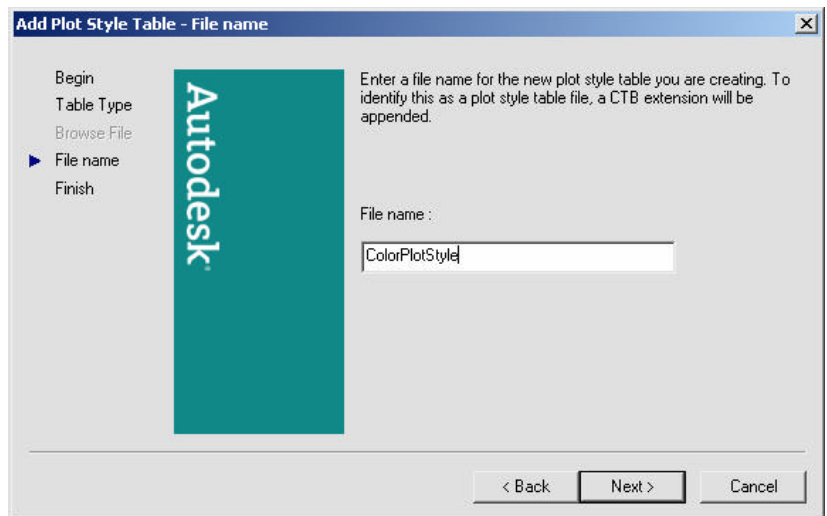

AutoCAD 2D Tutorial

10. **Choose** "Plot Style Table Editor..."

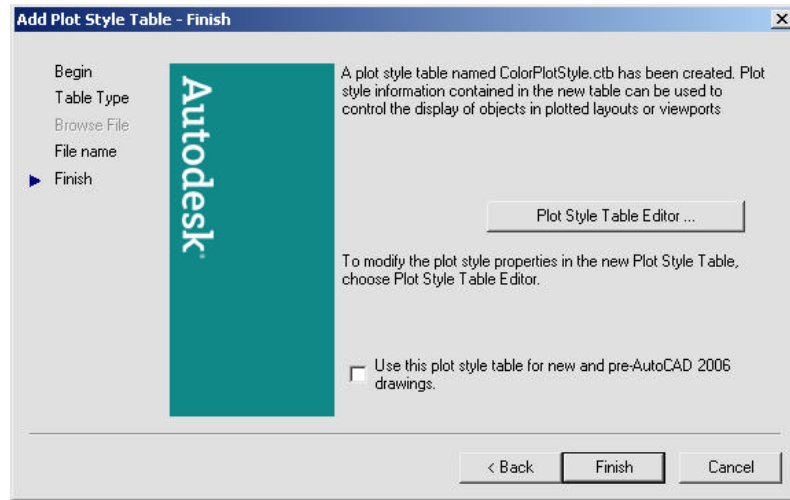

11. **Pick** an AutoCAD color and assign properties to it.

For example, if you want all RED objects to be plotted with a pen width of .25 mm, choose that lineweight.

12. **Choose** Save and Close

13. **Choose** Finish

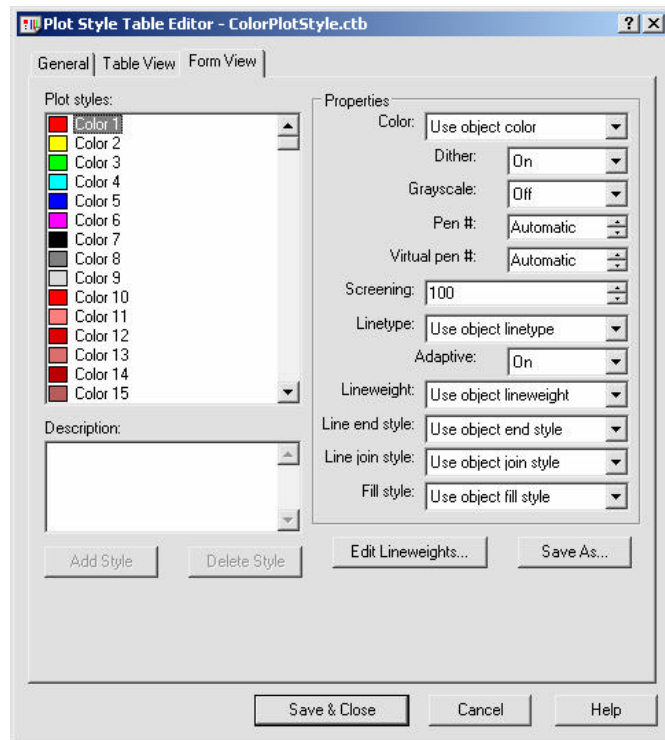

AutoCAD will save the file called COLORPLOTSTYLE.CBT

AutoCAD 2D Tutorial

Named Plot Styles 9.4

1. **Choose** File, Plot Style Manager.
2. **Double-Click** Add a Plot Style Table Wizard icon.
3. **Click** Next >
4. **Choose** Start from Scratch to create a new Plot Style.
5. **Click** Next >
6. **Choose** Named Plot Style Table
7. **Click** Next >
8. **Type** a name for the plot style table.
9. **Click** Next>
10. **Choose** “Plot Style Table Editor...”
11. **Create** names for various styles.
12. **Choose** Save and Close.

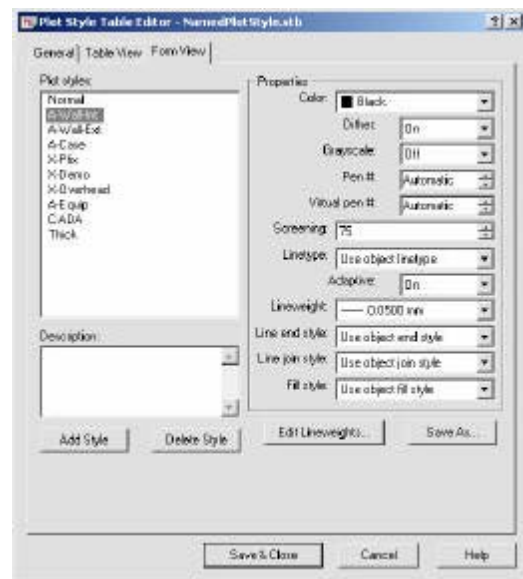
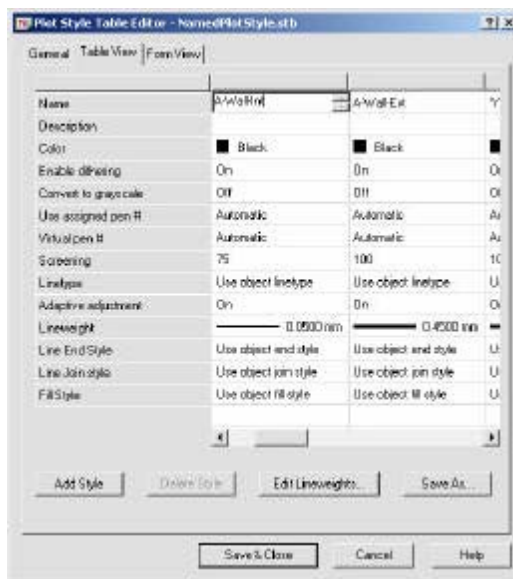

Chapter 10 Edit Commands

AutoCAD 2D Tutorial

Move Command 10.1

1. **Choose** Modify, Move.
or
2. **Click** the Move icon. 
- or
3. **Type** MOVE at the command prompt
Command: **MOVE or M**
4. **Pick** Objects to move
Select objects: (**select**)
5. **Pick** A point to move from
Base point or displacement: (**pick point**)
6. **Pick** A point to move to
Second point of displacement: (**pick point**)

Circle before move

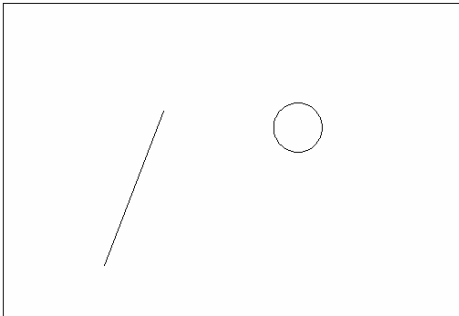

Circle after move

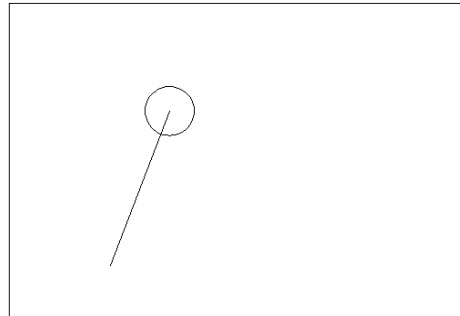

TIP:

To move an object a specified distance, type a distance at the second point of displacement prompt: **@1<0**

AutoCAD 2D Tutorial

Copy Command 10.2

1. **Choose** Modify, Copy.
or
2. **Click** the Copy icon. 
- or**
3. **Type** COPY at the command prompt.
Command: **COPY or CP**
4. **Pick** Objects to copy.
Select objects: (**select**)
5. **Pick** A point to move from.
Base point or displacement/Multiple: (**pick point**).
6. **Pick** A point to copy to.
Second point of displacement: (**pick point**)
or
7. **Type** A point to copy to.
Second point of displacement: **@ 1<0**

Duplicate objects copied

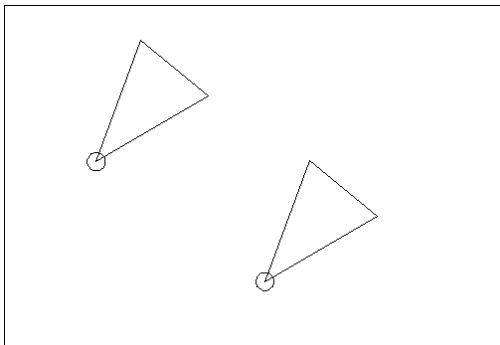

Multiple objects copied

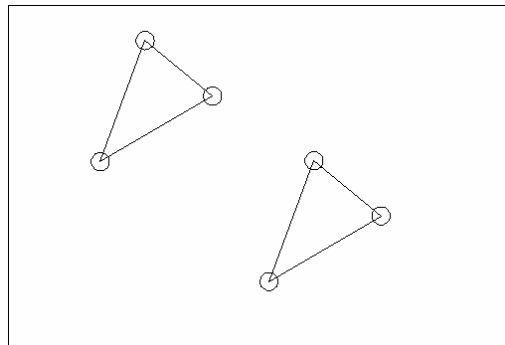

TIP:

- To copy many objects in the same copy command, type M for Multiple at the “Base point or displacement/Multiple” option.

AutoCAD 2D Tutorial

Previous Selection 10.3

Places selected objects in the Previous selection set

1. **Choose** Modify, Move.
or
2. **Click** the Move icon. 
3. **Type** MOVE at the command prompt.
Command: **MOVE or M**
4. **Pick** Objects to move.
Select objects: **(P)**

Previous Selection Set Highlighted

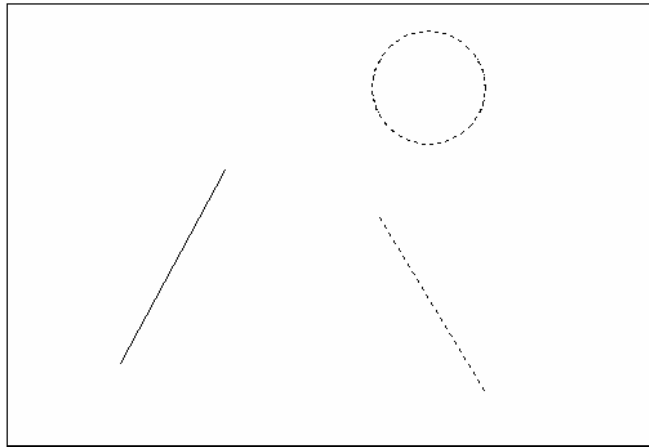

TIP:

AutoCAD requires that objects be selected in order to be processed. The Select Objects prompt occurs after many commands, including the SELECT command itself.

AutoCAD 2D Tutorial

Offset Command 10.4

Offset Distance

To offset a specified distance:

1. **Choose** Modify, Offset.
or
2. **Choose** the Offset icon. 
or
3. **Type** OFFSET at the command prompt.
Command: **OFFSET** or **O**
4. **Type** The distance to offset.
Offset distance or <Through point>: **(number)**
5. **Pick** The object to offset.
Select object to offset: **(select object)**
6. **Pick** A side to offset object to.
Side to offset: **(pick side)**
7. **Pick** Another object to offset
Select object to offset: **(pick side)**
or
8. **Press** Enter to end the command.

Offsetting objects by specifying a distance

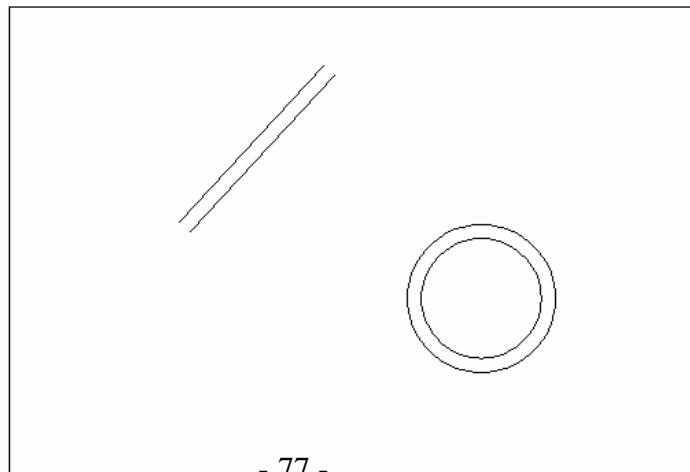

AutoCAD 2D Tutorial

Offset Through Point

To offset through point :

1. **Type** OFFSET at the command prompt
 Command: **OFFSET**
2. **Type** T to specify a through point
 Offset distance or <Through point>: **(T)**
3. **Pick** A point to offset through (HINT: use object
 snaps) Select object to offset: **(pick)**
 Through point: **(select object)**

Offset through a point

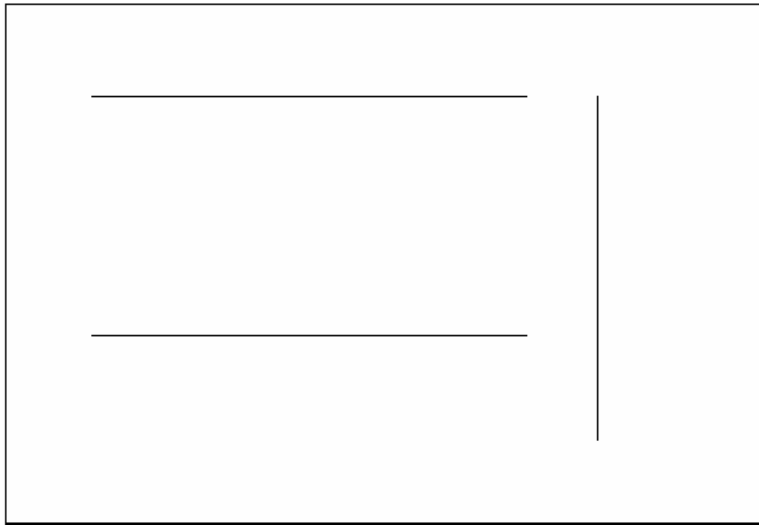

AutoCAD 2D Tutorial

EXTEND 10.5

1. **Choose** Modify, Extend.
or
2. **Click** the Extend icon. 
- or**
3. **Type** EXTEND at the command prompt
Command: **EXTEND**
Select boundary edge(s)...
4. **Pick** The BOUNDARY edge to extend to
Select objects: (**select**)
5. **Press** ENTER to accept the boundary edge
Select objects: (**press enter**)
6. **Pick** The objects to extend
<Select object to extend> / Project / Edge / Undo: Select an object, enter an option, or press enter : (**select**)
7. **Press** ENTER when you are done choosing objects

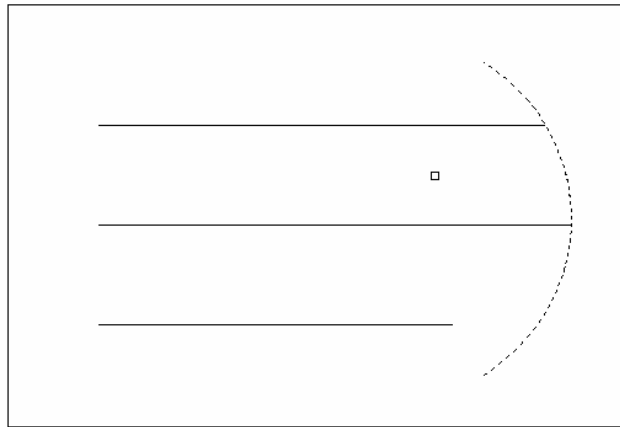

*Lines Extended
to an Arc
(Arc is boundary edge)*

TIP:

- Use the object selection option FENCE to choose multiple objects

AutoCAD 2D Tutorial

TRIM 10.6

The TRIM command allows you to trim objects in a drawing so they end precisely at a cutting edge defined by one or more other objects in the drawing.

1. **Choose** Modify, Trim.
or
2. **Click** the Trim icon. 
3. **Type** TRIM at the command prompt
Command: **TRIM**
Select cutting edge(s)...
4. **Pick** The CUTTING edge to extend to
Select objects: (**select**)
5. **Press** ENTER to accept the cutting edge
Select objects: (**press enter**)
6. **Pick** Objects to trim
<Select object to trim> / Project / Edge / Undo:
Select an object, enter an option, or press enter
7. **Press** ENTER when you are done choosing objects
Select object to trim/Undo: (**press enter**)

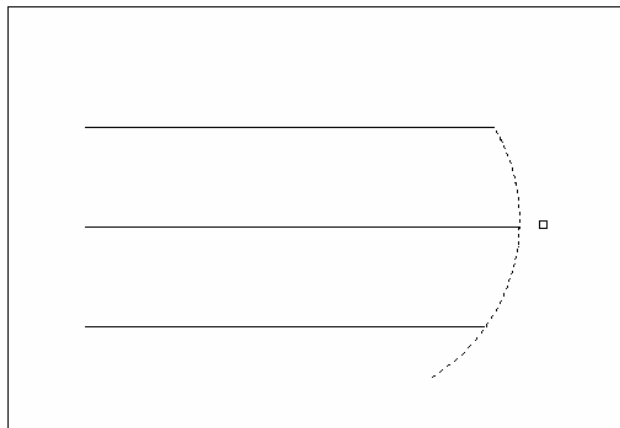

*Lines Trimmed
to an Arc
(Arc is cutting
edge)*

TIP: Hold the SHIFT key to interactively extend instead of trim.

AutoCAD 2D Tutorial

Edgemode

Controls how the TRIM and EXTEND commands determine cutting and boundary edges.

0 Uses the selected edge without an extension.

1 Extends the selected edge to its natural boundary.

AutoCAD 2D Tutorial

MIRROR 10.7

1. **Choose** Modify, Mirror.
or
2. **Click** the Mirror icon. 
or
3. **Type** MIRROR at the command prompt.
Command: **MIRROR**
4. **Pick** Objects to mirror.
Select objects:(**select**)
5. **Pick** First point of mirror line: (**point**)
6. **Pick** Second point: (**point**)
7. **Type** Yes to delete the original objects and
No to keep them.
Delete old objects? **Y** or **N**

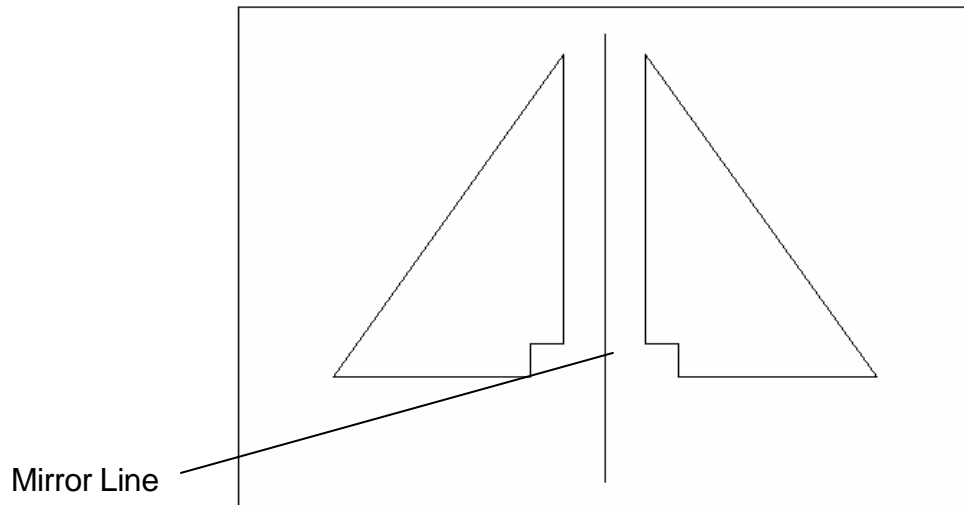

AutoCAD 2D Tutorial

Mirrtext 10.8

Mirror reflects (mirrors) text if 1, retains text direction if 0.

1. **Type** MIRRTEXT at the command prompt.

Command: **MIRRTEXT**

2. **Type** 1 to reflect the text and 0 to retain the text.

Current value <0> New value: **1** or **0**

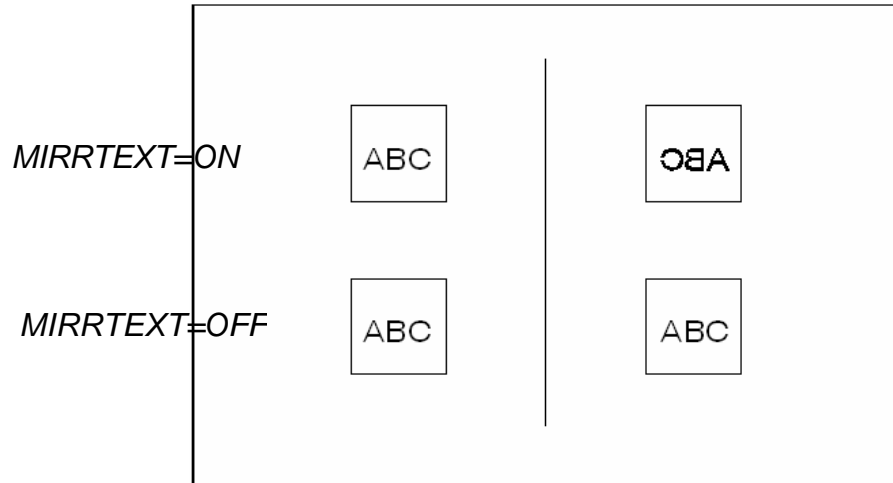

AutoCAD 2D Tutorial

ROTATE 10.9

1. **Choose** Modify, Rotate.
or
2. **Click** the Modify icon. 
or
3. **Type** ROTATE at the command prompt
Command : **ROTATE**
4. **Pick** Objects to rotate:
Select objects:(**select**)
5. **Pick** A pivot point to rotate around
Base point: (**point**)
6. **Type** A rotation angle<Rotation angle>/Reference:
(**number**)
or
7. **Pick** A rotation angle<Rotation angle>/Reference: (**point**)

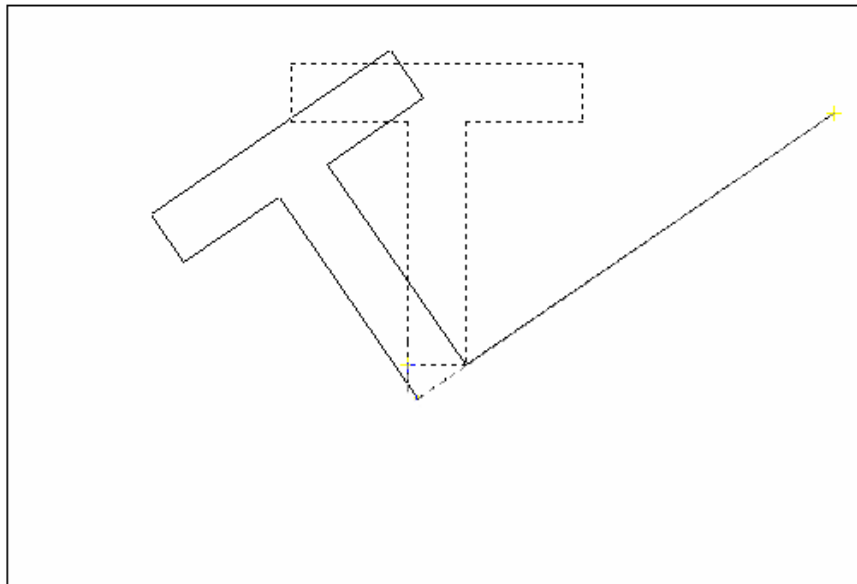

AutoCAD 2D Tutorial

Reference Angle Rotation

A positive angle causes counterclockwise rotation, and a negative angle produces clockwise rotation. If you respond to the last prompt with r, you can specify the current rotation and the new rotation you want. AutoCAD prompts:

1. **Type** R for a rotation angle<Rotation angle>/Reference: (**R**)
2. **Choose** An existing rotation angle Rotation angle:
(**number or points**)
3. **Choose** A new rotation angle New angle:
(**number or points**)

TIP:

You can show AutoCAD the reference angle (by pointing to the two endpoints of a line to be rotated), and then specify the new angle. You can specify the new angle by pointing or by dragging the object.

AutoCAD 2D Tutorial

SCALE 10.10

1. **Choose** Modify, Scale.
or
2. **Click** the Scale icon. 
or
3. **Type** SCALE at the command prompt
Command: **SCALE**
Select objects: (**select objects**)
4. **Pick** A pivot point to scale about Base point: (**point**)
5. **Type** A rotation angle<Scale factor>/Reference:(**number**)
or
6. **Pick** A scale factor<Scale factor>/Reference:
(**point**)
Scale factor/Reference: (**points**)

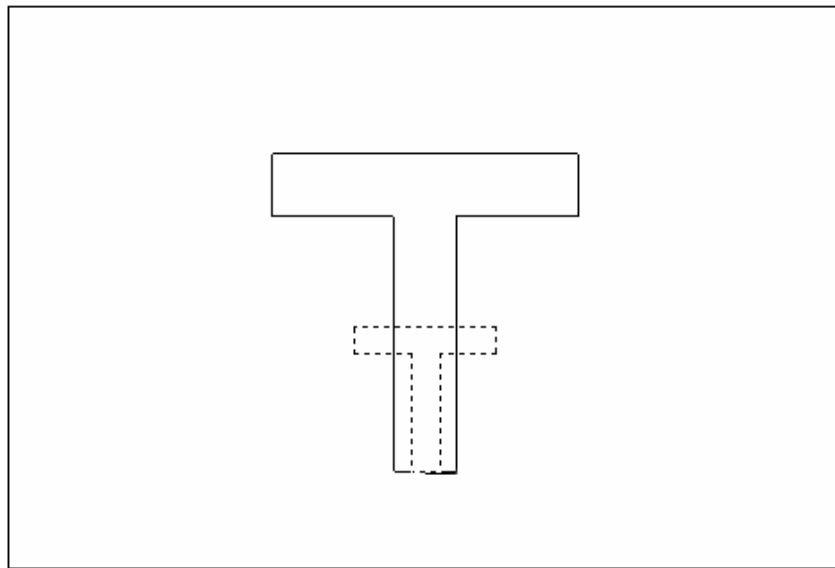

AutoCAD 2D Tutorial

Scale by Specifying Length

You can show AutoCAD the reference length (by pointing to the two endpoints of a line to be scaled), and then specify the new length. You can specify the new length by pointing, or by dragging the object.

1. **Type** R to define a reference length
Scale factor/Reference: (R)
2. **Choose** A reference scale factor
Reference length : (number or points)
3. **Choose** A new scale factor
New length: (number or points)

Chapter 11 Text

AutoCAD 2D Tutorial

Text Command 11.1

Text

Creates a single-line text object

1. **Type** TEXT at the command prompt
Command: **TEXT**
or
2. **Pick** the Single Line Text icon from the Text Toolbar. 
3. **Pick** A start point
Justify/Style/<Start Point>: (**point**)
or
4. **Type** J to change the justification or S to change the text style.
5. **Type** A text height
Height <default>: (**type value or pick two points**)
6. **Type** A rotation angle
Rotation angle <default>: (**angle or point**)
7. **Type** A text string
Text: (**type text string**)
8. **Press** enter to exit the Text: prompt.

DTEXT (Dynamic Text)

Creates a single-line text object, showing the text dynamically on the screen as it is entered.

1. **Choose** Draw, Text, Single Line Text.
or
2. **Type** DTEXT at the command prompt
Command : **DTEXT**
3. **Follow** the steps 3-8 from above.

AutoCAD 2D Tutorial

Text Justification 11.2

1. **Type** JUSTIFYTEXT at the command prompt
Command: **JUSTIFYTEXT**

or

2. **Pick** the Justify Text icon from the Text Toolbar.



AutoCAD 2D Tutorial

Text Justifications

- A** Aligns text between two designated endpoints (height and angle are not requested in this case).
- C** Centers the text around a specified point.
- F** Aligns the text between two designated endpoints with a specified height that varies only in its X scale factor.
- M** Centers the text both horizontally and vertically around a specified point.
- R** Right justifies the text at a designated endpoint.
- S** Selects a different text style.
- TL** Starts the top left portion of text at a given point.
- TC** Centers the top center of the text at a given point.
- TR** Ends the top of text at a given point.
- ML** Starts the middle left portion of the text at a given point.
- MC** Centers the middle of text at a given point.
- MR** Ends the text at the middle right portion at a given point.
- BL** Starts the bottom left portion of the text at a given point.
- BC** Centers the bottom center portion of the text at a given point.
- BR** Ends the bottom of text at a given point.

AutoCAD 2D Tutorial

Text Styles 11.3

Style Command

1. **Choose** Format, Text Style...
or
2. **Type** STYLE at the command prompt.
Command: **STYLE**
3. **Pick** the Text Style icon from the Text Toolbar.
4. **Choose** a style from the menu or create a NEW style.
5. **Choose** a font file.
6. **Type** a height for the text (set to zero to vary heights)
7. **Type** a width factor for each character.
Width factor <1>: (**enter**)
8. **Type** an obliquing (slant) angle.
Obliquing angle <0>: (**angle or enter**)
9. **Type** Yes or No to place characters backwards.
Backwards? (**Y or N**)
10. **Type** Yes or No to draw characters upside down.
Upside down? (**Y or N**)
11. **Type** Yes or No to draw characters vertically

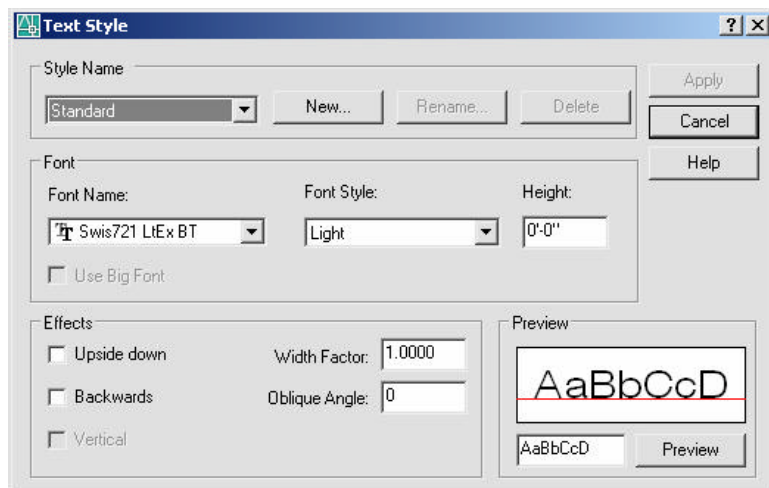

AutoCAD 2D Tutorial

Font Files

AutoCAD supports the following font types:

.SHX	AutoCAD Fonts
.PFB	Adobe Type I Fonts
.PFA	
.TTF	Windows True Type Fonts

TIP:

To replace the font globally in a drawing, type style at the command prompt and keep the same style name but replace the font file with the new font. When AutoCAD regenerates, it will replace all text drawn with that style with the new font.

AutoCAD 2D Tutorial

Multiline Text 11.4

Mtext Command

1. **Choose** Draw, Text, Multiline Text...
or
2. **Pick** the Mtext icon. 
or
3. **Type** MTEXT at the command prompt.
Command: **MTEXT**
4. **Type** One of the following options
Height/Justify/Rotation/Style/Width:
or
5. **Pick** 2Points to define the text window.



6. **Type** text or change an MTEXT setting.

AutoCAD 2D Tutorial

MTEXT options:

- Rotation** Controls the rotation angle of the text boundary.
- Style** Specifies the text style to use in paragraph text.
- Height** Specifies the height of uppercase text
- Direction** Specifies whether text is vertical or horizontal.
- Width** Specifies the width of the text boundary.

MTEXT Editor

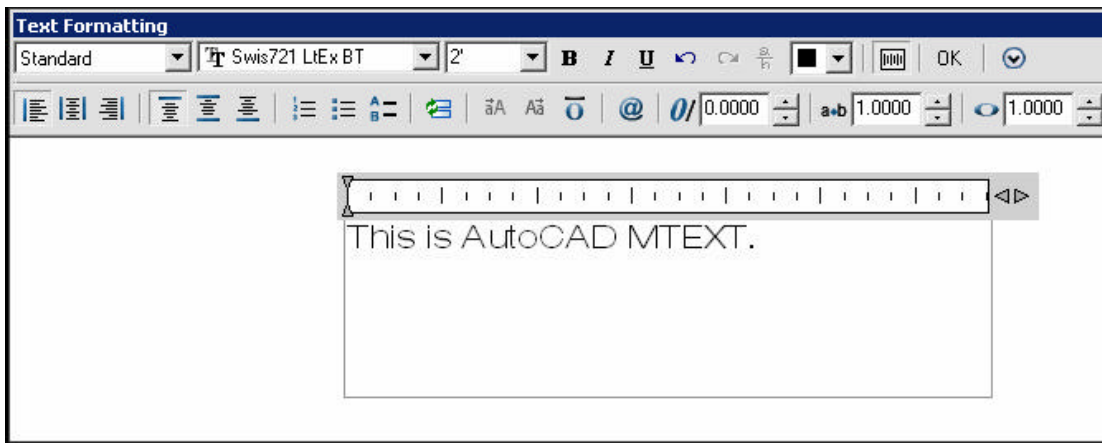

AutoCAD 2D Tutorial

Editing Text 11.5

DDEDIT

1. **Choose** Modify, Text...
or
2. **Click** the Edit Text icon from the Text toolbar. 
3. **Type** DDEDIT at the command prompt.
Command: **DDEDIT** or **ED**
4. **Pick** The text to edit.
Select objects: (pick text)
5. **Pick** Additional text or ENTER to end the command.
Select objects: ENTER

Text Edit Dialog Box for TEXT and DTEXT Commands



Text Edit for MTEXT command

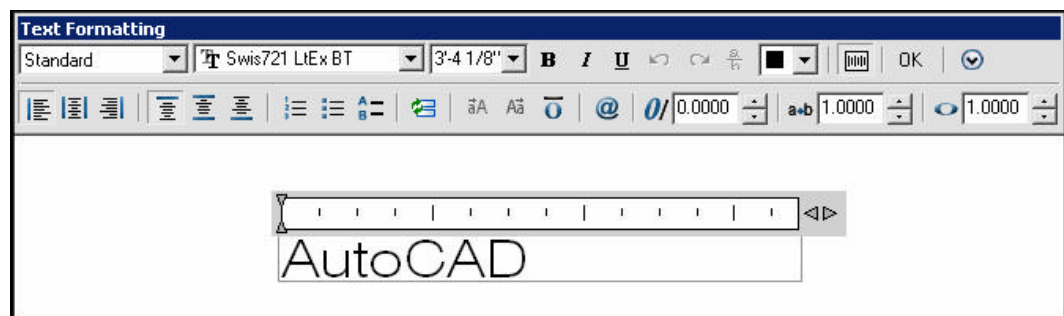

AutoCAD 2D Tutorial

Special Control Codes 11.6

AutoCAD provides special control codes to return drafting symbols when using text.

- Type** The following characters to return equivalent symbol:

%%d	degree symbol (°)
%%c	diameter symbol (∅)
%%p	plus minus symbol (±)
%%u	to start and stop underlining (NOTE)
%%o	to start and stop overscoring (NOTE)

The MTEXT command has additional symbols that can be accessed by right-clicking in the MText Editor for more Special Symbols.

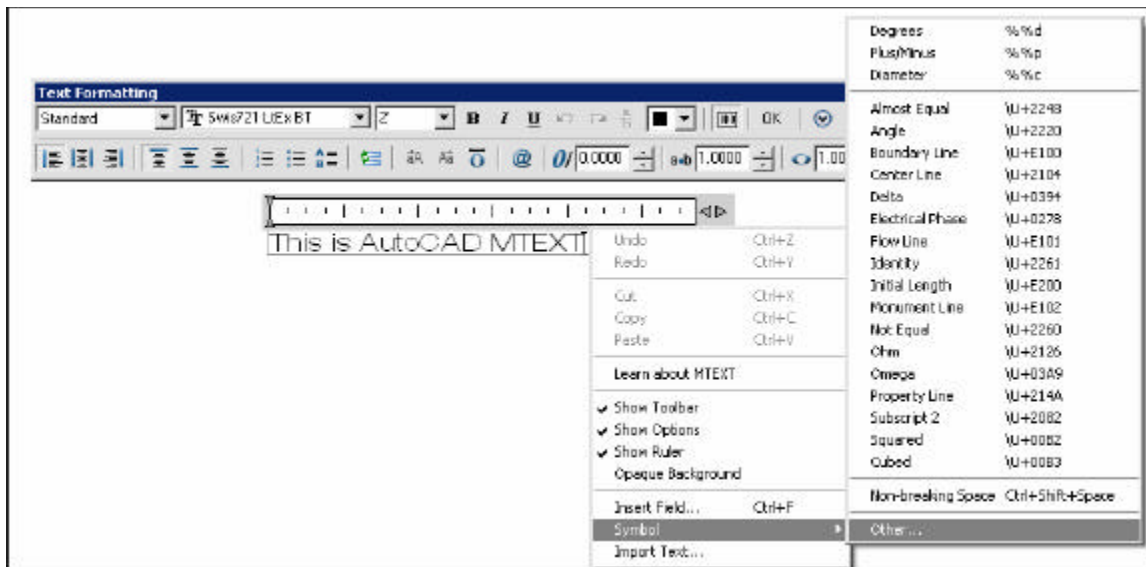

AutoCAD 2D Tutorial

Spell Check 11.7

1. **Choose** Tools, Spelling
or
2. **Type** SPELL at the command prompt.
Command: **SPELL**
3. **Pick** The text to spell check.
Select objects: (**pick text**)
4. **Choose** Change or Ignore to modify or accept the spelling of a word.

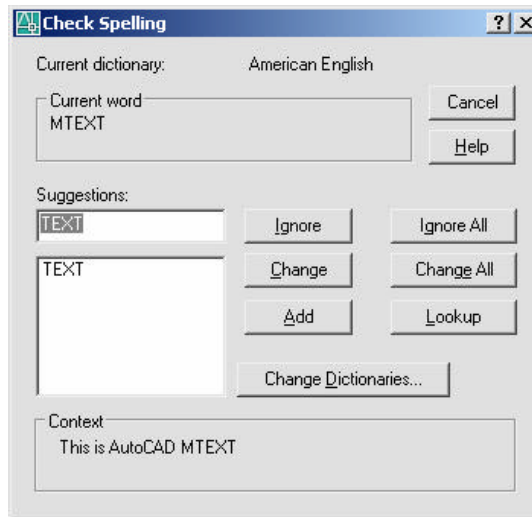

5. **Pick** Change Dictionaries to create your own dictionary.

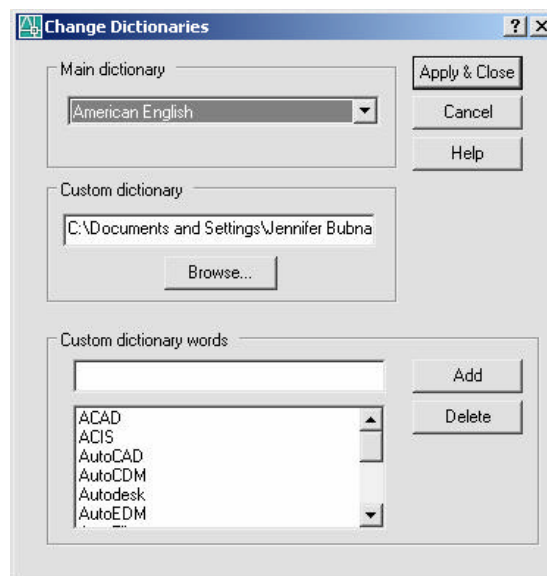

AutoCAD 2D Tutorial

Annotative Text

Use annotative text for notes and labels in your drawing. You create annotative text by using an annotative text style, which sets the height of the text on the paper.

The current annotation scale automatically determines the display size of the text in model space or paper space viewports.

For example, you want text to display at a height of 3/16" on the paper, so you can define a text style to have a paper height of 3/16". When you add text to a viewport that has a scale of 1/2"=1'0", the current annotation scale, which is set to the same scale as the viewport's, automatically scales the text to display appropriately at 4.5".

1. Create an Annotative text style using the **STYLE** command.

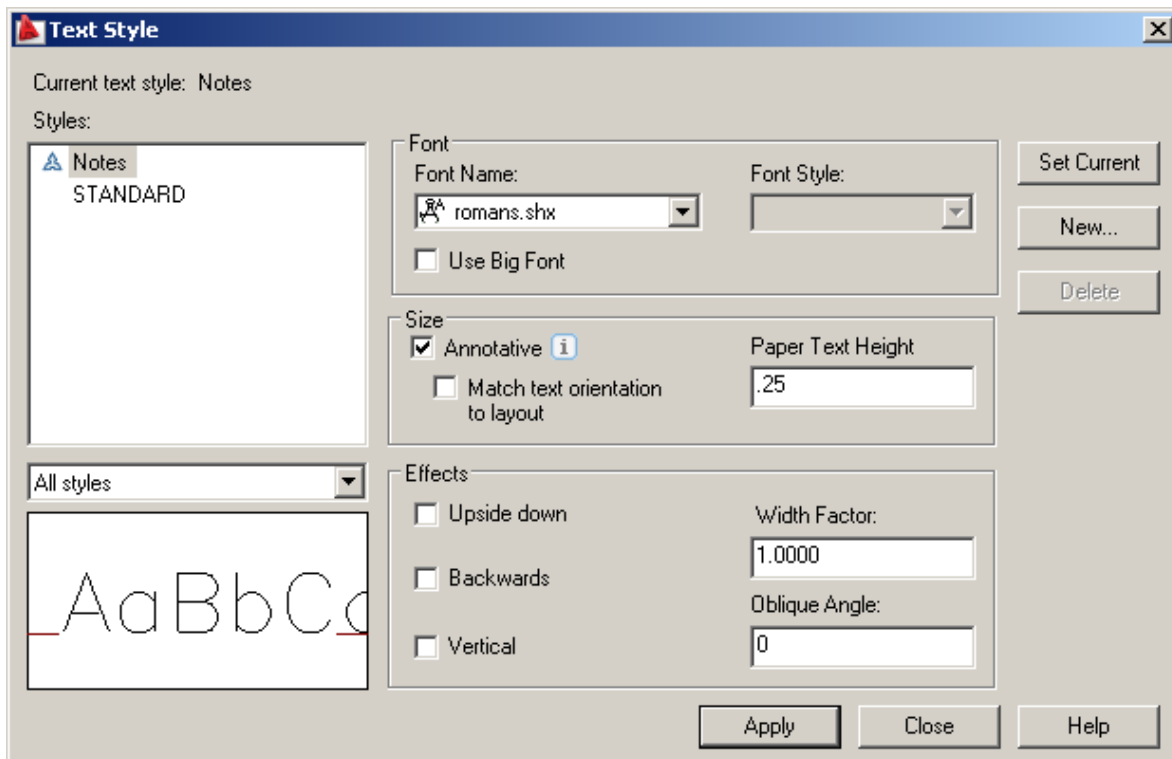

AutoCAD 2D Tutorial

Annotative Hatch

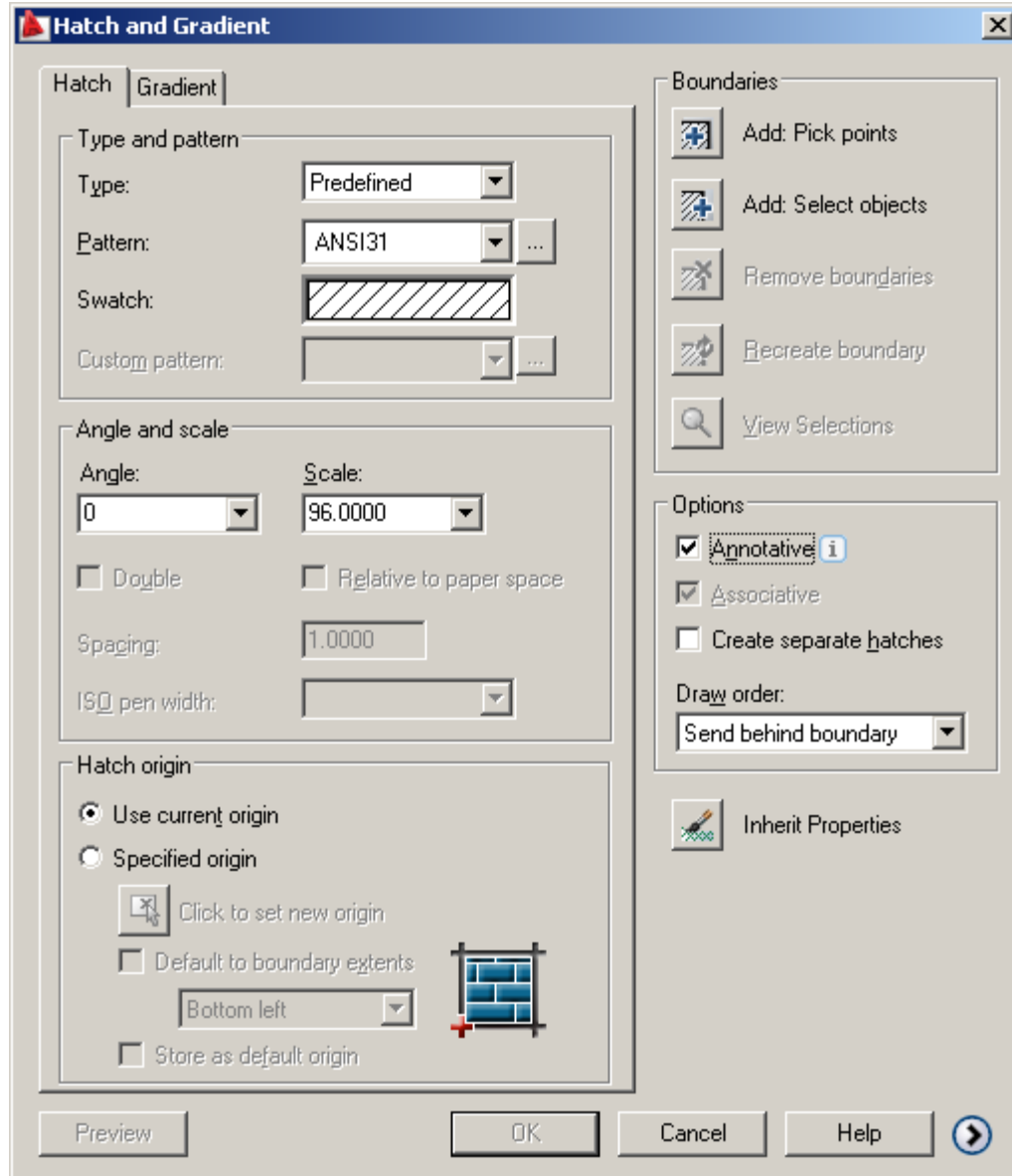

AutoCAD 2D Tutorial

Scales

Add Scale

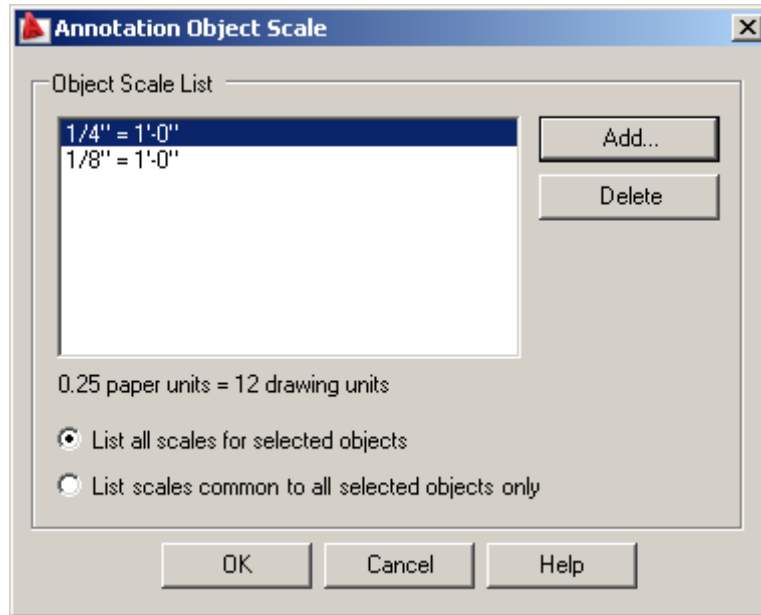

Change Scales

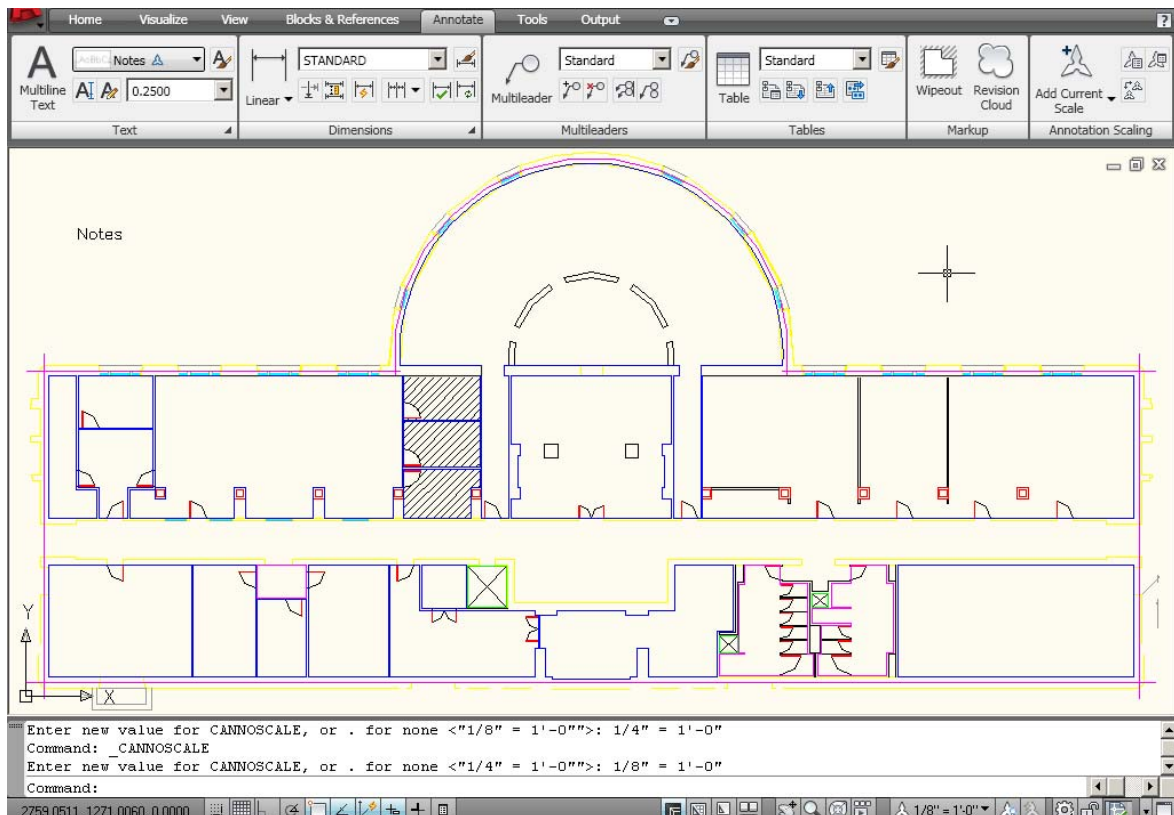

AutoCAD 2D Tutorial

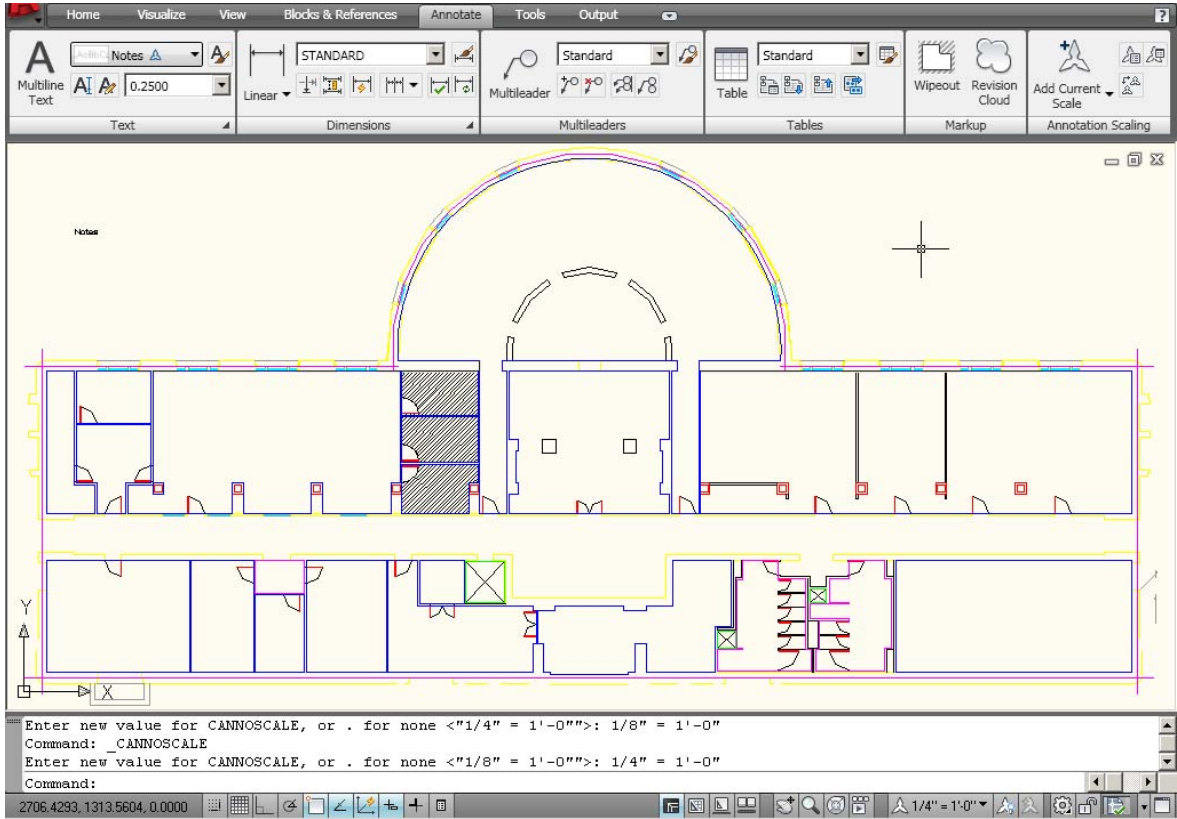

Chapter 12

Layers, Linetypes, Colors

AutoCAD 2D Tutorial

Introduction to Layers and Layer Dialog Box 12.1

1. **Choose** Format, Layer.
or
2. **Type** LAYER at the command prompt.
Command: **LAYER (or LA)**
or
3. **Pick** the layers icon from the Layer Control box on the object properties toolbar.



AutoCAD 2005

Layer Properties

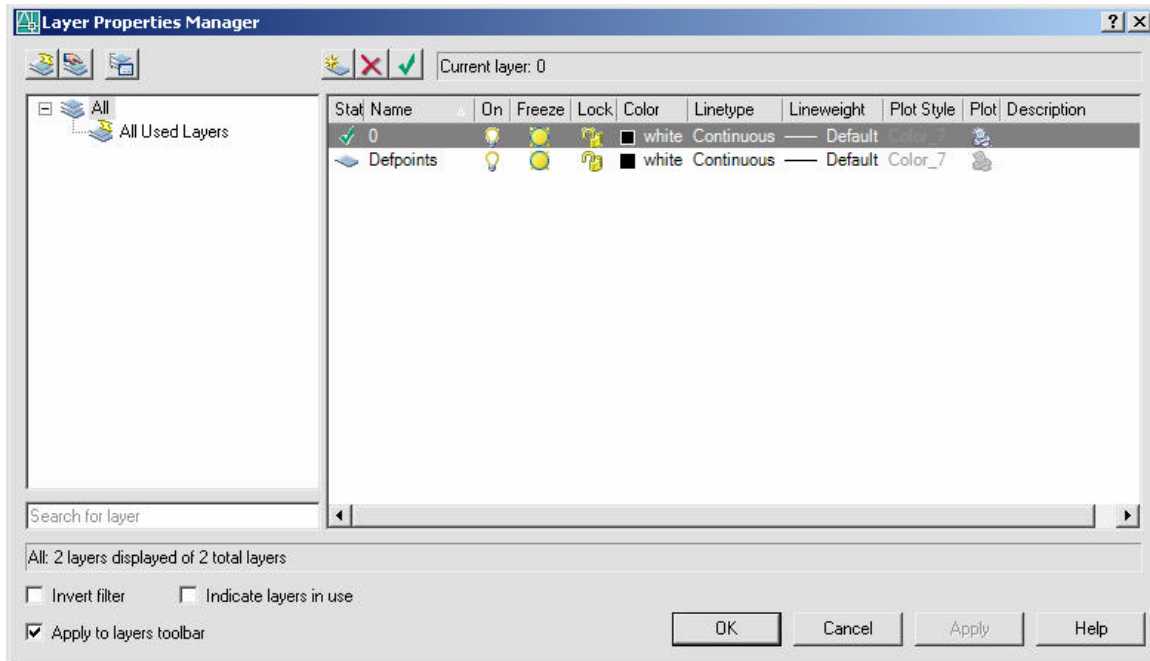

AutoCAD 2D Tutorial

Layer Options 12.2

?	Lists layers, with states, colors and linetypes.
Make	Creates a new layer and makes it current.
Set	Sets current layer.
New	Creates new layers .
ON	Turns on specified layers.
OFF	Turns off specified layers.
Color	Assigns color to specified layers.
Ltype	Assigns linetype to specified layers.
Freeze	Completely ignores layers during regeneration.
Thaw	Unfreezes specified layers Ltype.
Lock	Makes a layer read only preventing entities from being edited but available visual reference and osnap functions.
Unlock	Places a layer in read write mode and available for edits.
Plot	Turns a Layer On for Plotting
No Plot	Turns a Layer Off for Plotting
LWeight	Controls the line weight for each layer

TIP:

Layers can be set using the command line prompts for layers. To use this, type -LAYER or -LA at the command prompt

1. **Type** Command: **-LAYER** or **LA**
2. **Type** One of the following layer options
?/Make/Set/New/ON/OFF/Color/Ltype/Freeze/Thaw:

AutoCAD 2D Tutorial

Layer Shortcuts 12.3

Changing the Layer of an Object

1. **Click** Once on the object to change.
2. **Select** the desired layer from the Layer Control Box dropdown.

AutoCAD will move the object to the new layer.

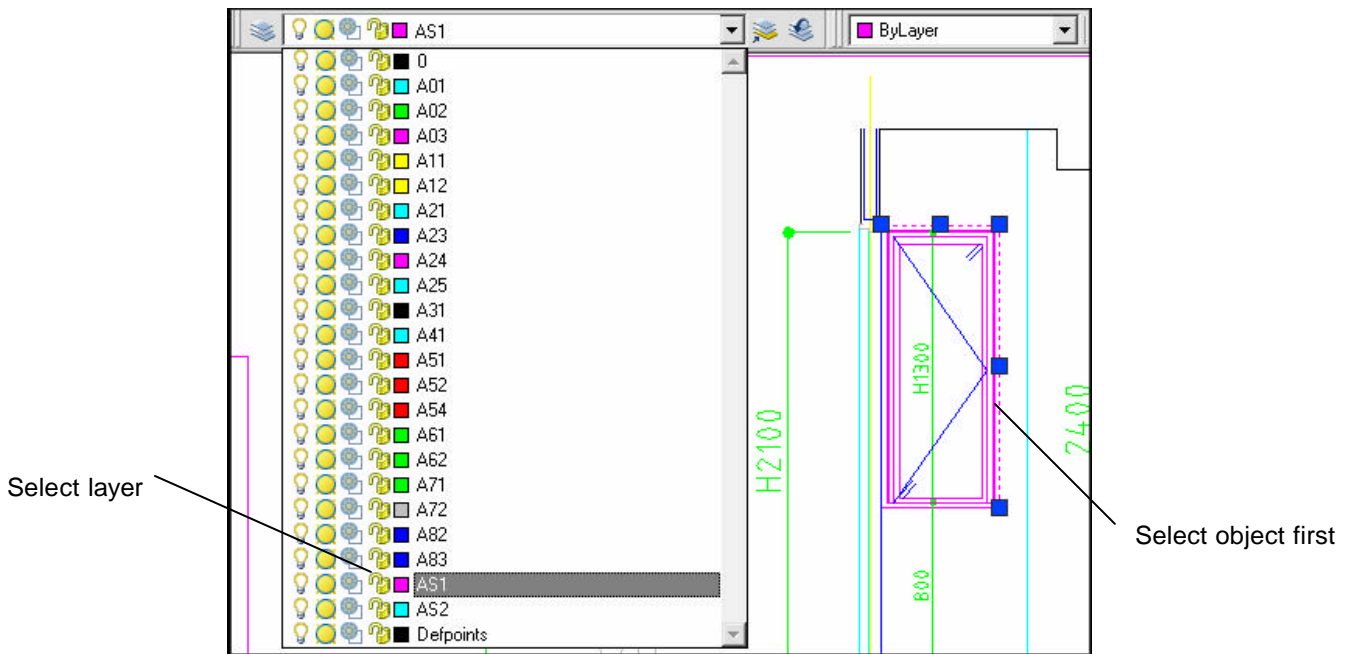

AutoCAD 2D Tutorial

Making a Layer Current

1. **Click** once on the Make Object's Layer Current icon. 
2. **Select** object whose layer will become current:

Match Properties

1. **Choose** Modify, Match Properties.
or
2. **Click** the Match Properties Icon from the Standard toolbar.
or
3. **Type** Command : **MATCHPROP** or **MA**
4. **Select** the object whose properties you want to copy (1).
5. **Select** the objects to which you want to apply the properties (2).

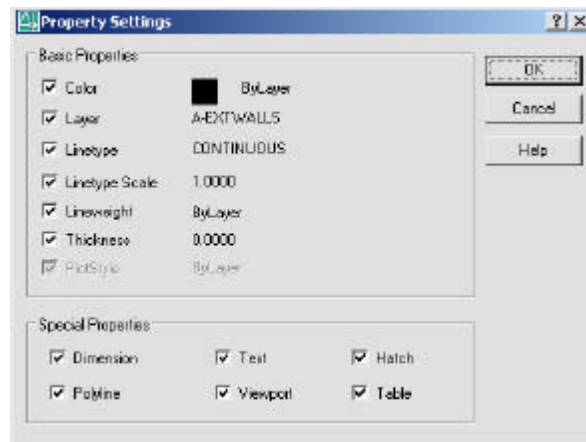

AutoCAD 2D Tutorial

Layer Previous 12.4

1. **Open** an AutoCAD drawing with layers.
2. **Turn** layers on/off.
3. **Zoom** or perform any AutoCAD Command.
4. **Type** LAYERP at the command prompt.

Command: LAYERP

or

5. **Click** the Layer Previous icon. 

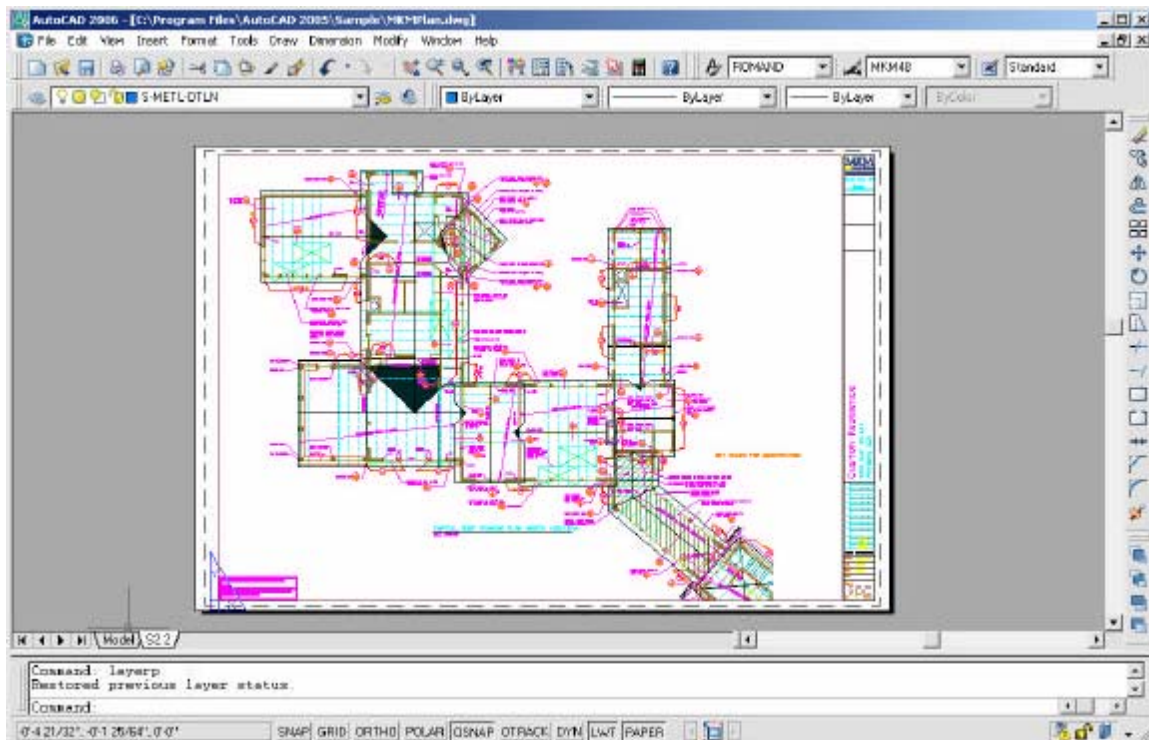

AutoCAD 2D Tutorial

Layer States 12.5

1. **Choose** the layer icon.
2. **Select** various layers to be ON,OFF,FROZEN,LOCKED, etc.
3. **Choose** the Save State button.
4. **Choose** Restore State to restore the layer settings.

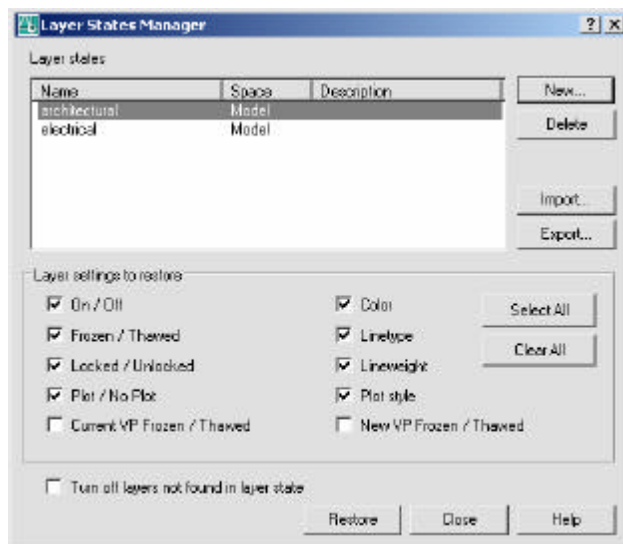
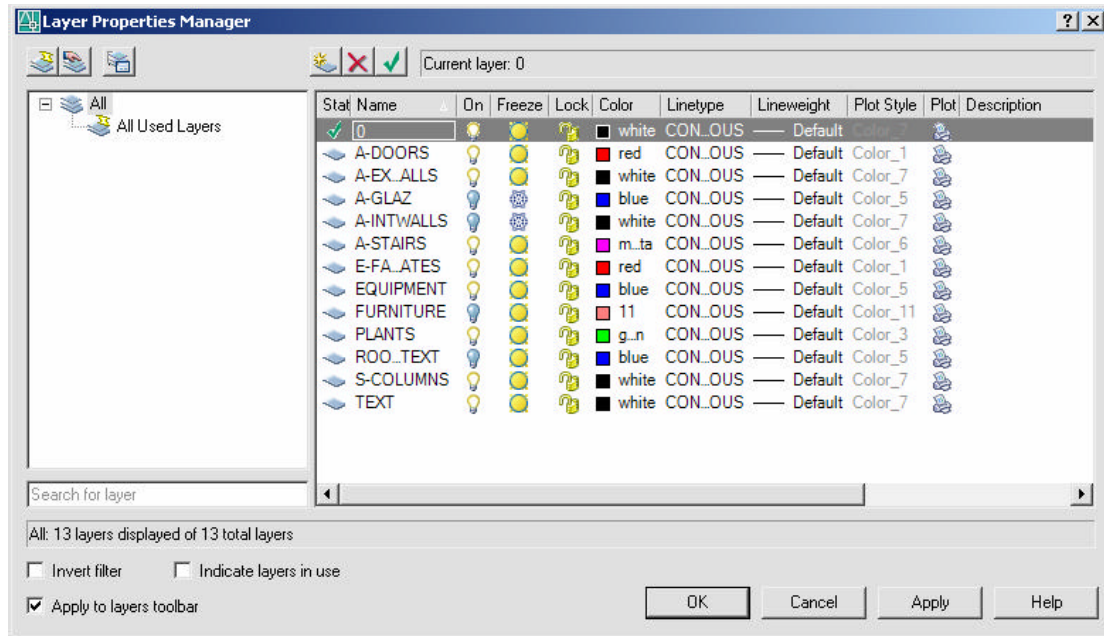

AutoCAD 2D Tutorial

Color Command 12.6

1. **Choose** Format, Color.
or
2. **Type** DDCOLOR at the command prompt.
Command: **DDCOLOR or COL**
or
3. **Choose** Color on the Object Properties toolbar and then select a color from the list or select Other to display the Select Color dialog box.

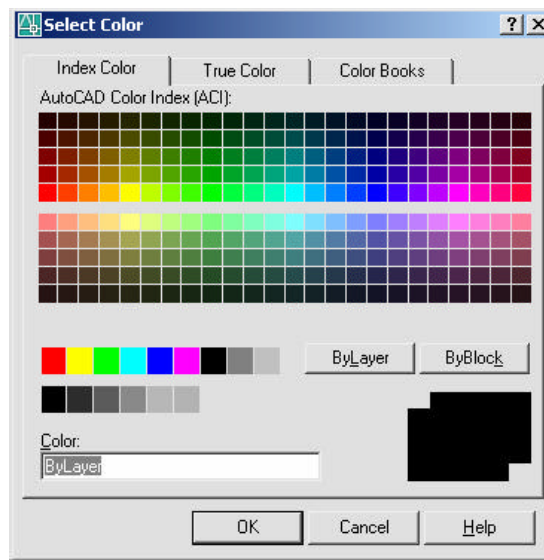

TIP:

These settings ignore the current layer settings for color.

By Layer

If you enter bylayer, new objects assume the color of the layer upon which they are drawn.

By Block

If you enter byblock, AutoCAD draws new objects in the default color (white or black, depending on your configuration) until they are grouped into a block. When the block is inserted in the drawing, the objects in the block inherit the current setting of the COLOR command.

AutoCAD 2D Tutorial

Linetypes 12.7

Loading and Changing Linetypes

1. **Choose** Format, Linetype...
or
2. **Type** DDLTYPE at the command prompt.
Command: **DDLTYPE** or **LT**
3. **Choose** Load... to see a list of available linetypes.



4. **Choose** the desired linetype to assign.

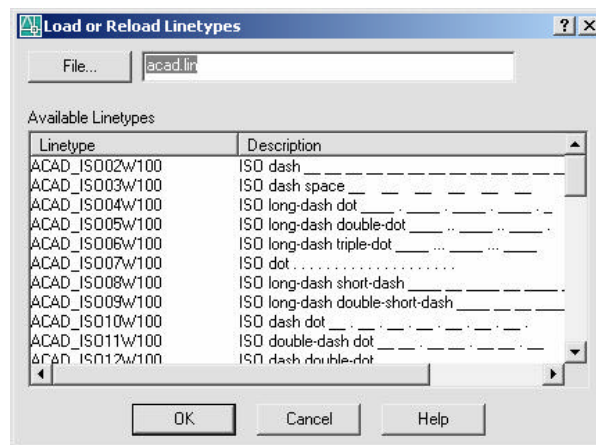

5. **Click** OK.

AutoCAD 2D Tutorial

Lineweights 12.8

Loading and Changing Lineweights

1. **Choose** Format, Lineweight...
- or**
2. **Type** LINEWEIGHT at the command prompt.
Command: **LINEWEIGHT** or **LWEIGHT**
- or**
4. **Pick** a lineweight to make current from the Object Properties menu.

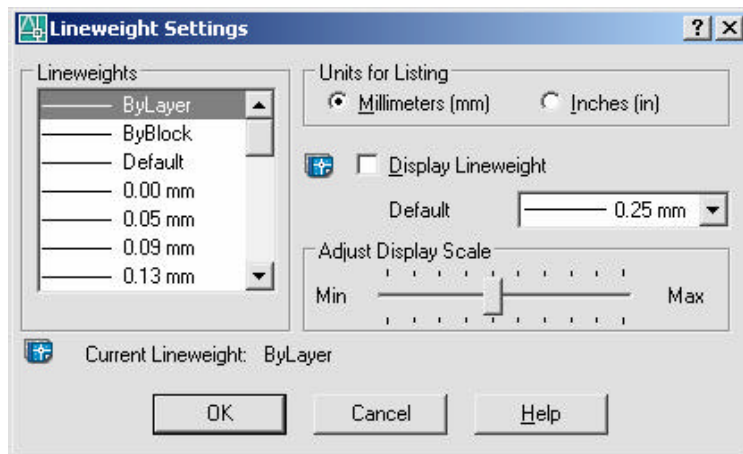

TIPS:

- Lineweights can also be assigned to layers.
- The Display Lineweights feature can be turned on/off on the status bar to show or not show lineweights in the drawing, thus making regenerations faster.

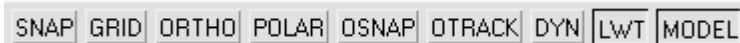

- Lineweights are displayed using a pixel width in proportion to the real-world unit value at which they plot. If you are using a high-resolution monitor, you can adjust the lineweight display scale to better display different lineweight widths.

AutoCAD 2D Tutorial

Object Properties 12.9

1. **Choose** Modify, Properties.
or
2. **Click** the Properties icon.
or 
3. **Type** DDCHPROP or DDMODIFY at the command prompt.
Command: **DDCHPROP** (CH) or
DDMODIFY (MO)
4. **Pick** Objects whose properties you want to change
Pick a window for DDCHPROP, single object for DDMODIFY.
Select objects:(select)
5. **Press** ENTER to accept objects.
Select objects: (press enter)
6. **Choose** One of the following properties to change.

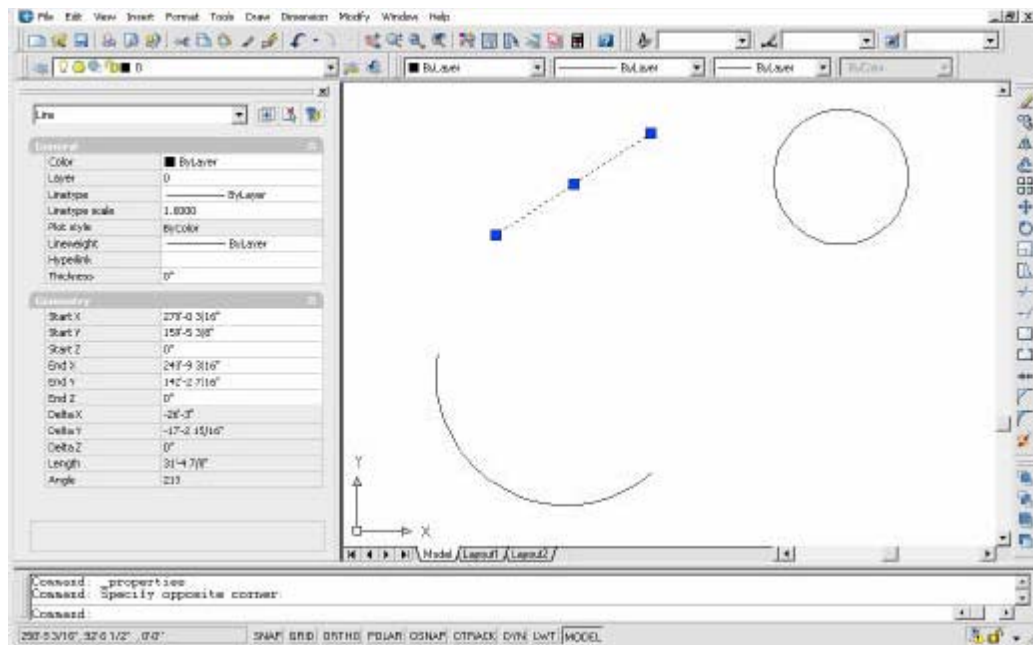

Chapter 13
More Edit Commands

AutoCAD 2D Tutorial

Break 13.1

1. **Choose** Modify, Break.
or
2. **Click** the Break icon. 
or
3. **Type** BREAK at the command prompt. Command: **BREAK**
4. **Pick** Object to break.
Select object: (**select one object**)
5. **Pick** A second break point.
Enter second point : (**point**)

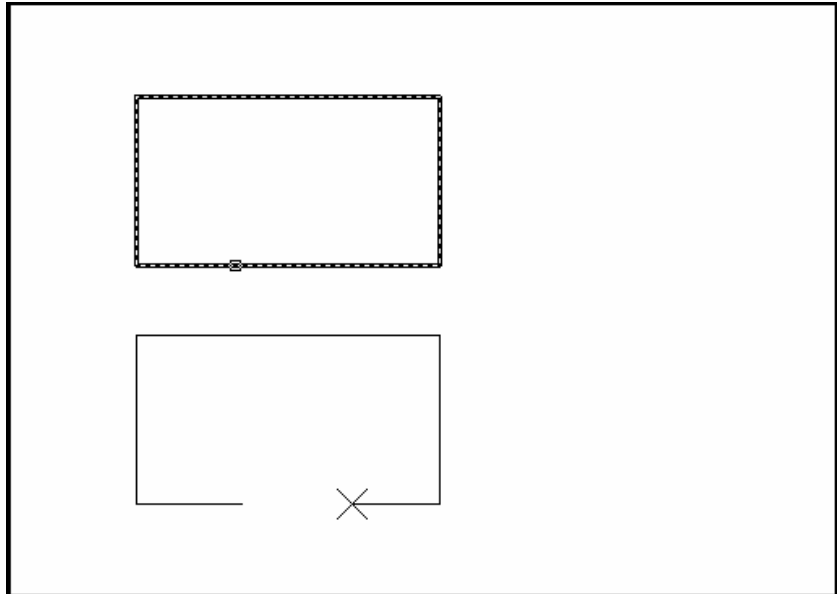

or

6. **Type** F to choose a different break point
Enter second point (or F for first point):(**F**)

AutoCAD 2D Tutorial

7. **Pick** The first break point on the object
Enter first point: **(point)**
8. **Pick** A second break point

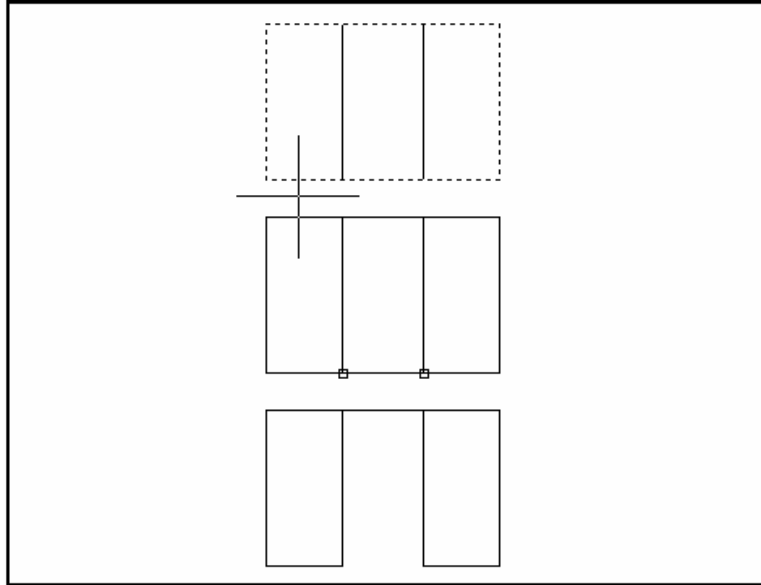

TIP:

You can also type coordinates instead of picking a break point. Enter second point (or F for first point):
@3'<0

If you break a circle, it changes to an arc by deleting the portion from the first point to the second, going counterclockwise.

Breaking a Polyline with nonzero width will cause the ends to be cut square.

AutoCAD 2D Tutorial

Stretch 13.2

1. **Choose** Modify, Stretch.
or
2. **Click** the Stretch icon. 
3. **Type** STRETCH at the command prompt.
Command : **STRETCH** Select
objects to stretch by window...
4. **Type** C to choose CROSSING window
Select objects: **C**
5. **Pick** A first corner to stretch. First corner: **(point)**
6. **Pick** The opposite corner to window the objects to stretch.
Other corner: **(point)**

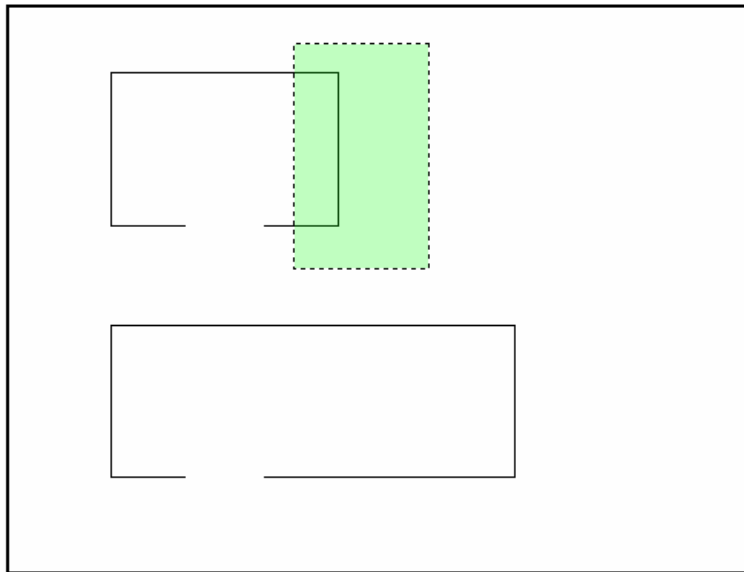

7. **Press** ENTER to accept objects to stretch.
8. **Pick** A base point to stretch from Base point:
(point)

AutoCAD 2D Tutorial

- 9. **Pick** A point to stretch to Newpoint: (**point**)
or
- 10. **Type** A distance to stretch. Newpoint: **@1<0**

TIP:

The Stretch command must use a CROSSING window or a CROSSING POLYGON window.

AutoCAD 2D Tutorial

Fillet 13.3

1. **Choose** Modify, Fillet.
or
2. **Click** the Fillet icon. 
or
3. **Type** FILLET at the command prompt. Command: **FILLET**
4. **Pick** First object to fillet. Polyline/Radius/Trim<Select two objects>: select first object.
5. **Pick** Second object to fillet.
Select second object: select second object.
or
6. **Type** One of the following options:

- P** Fillets a entire Polyline.
- R** Sets the fillet radius.
- T** Sets the trim mode (trim cuts the fillet corner and no trim keeps the fillet corner).

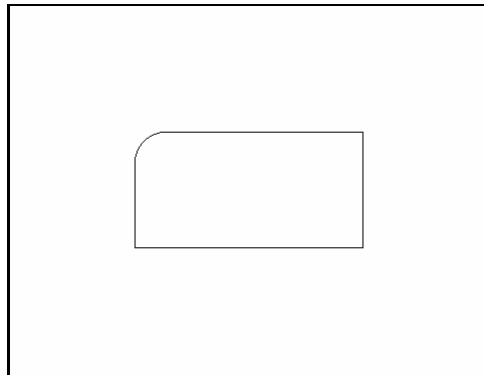

TIP:

- You can also fillet PARALLEL lines as well as PLINES with LINES
- Type a radius of zero (0) to create a clean 90 degree corner.

AutoCAD 2D Tutorial

Chamfer 13.4

1. **Choose** Modify, Chamfer.
or
2. **Click** the Chamfer icon. 
or
3. **Type** CHAMFER at the command prompt.
Command: **CHAMFER**
4. **Pick** First object to chamfer.
Polyline/Distance/Angle/Trim/Method<Select first line>: **select first object**
5. **Pick** Second object to chamfer.
Select second object: select second object.
or
6. **Type** One of the following options:

P Chamfers entire Polyline.
D Sets chamfer distances.
A Uses a distance and angle method instead of two distances.
T Sets the trimmode
M Sets the method to distance or angle.

Chamfer with equal distances

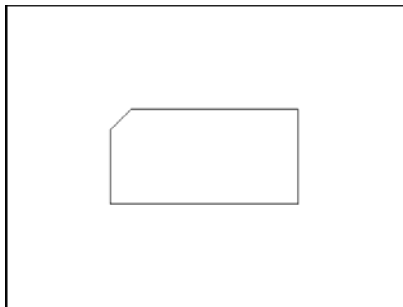

Chamfer with different distances

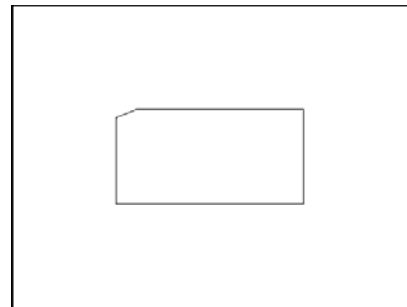

AutoCAD 2D Tutorial

Array 13.5

Rectangular Array

To draw rectangular array:

1. **Choose** Modify, Array.
or
2. **Click** the Array icon. 
3. **Type** *ARRAY* at the command prompt. Command : **ARRAY**
4. **Pick** Objects to array. Select objects : (**select**)
5. **Type** *The number of rows top to bottom.* Number of rows(---) <1>: (**number**)
6. **Type** *The number of columns left to right.* Number of columns (|||)<1>: (**number**)
7. **Type** *The unit cell distance between items in each row.* *Distance between rows: (+ number=up, -number =down)*
8. **Type** *The unit cell distance between items in each column.* *Distance between columns: (+number=right, - number =left)*

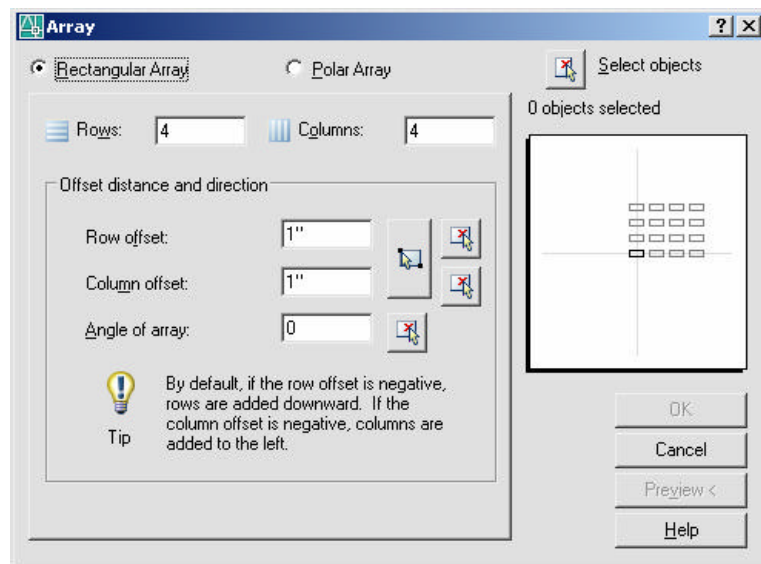

AutoCAD 2D Tutorial

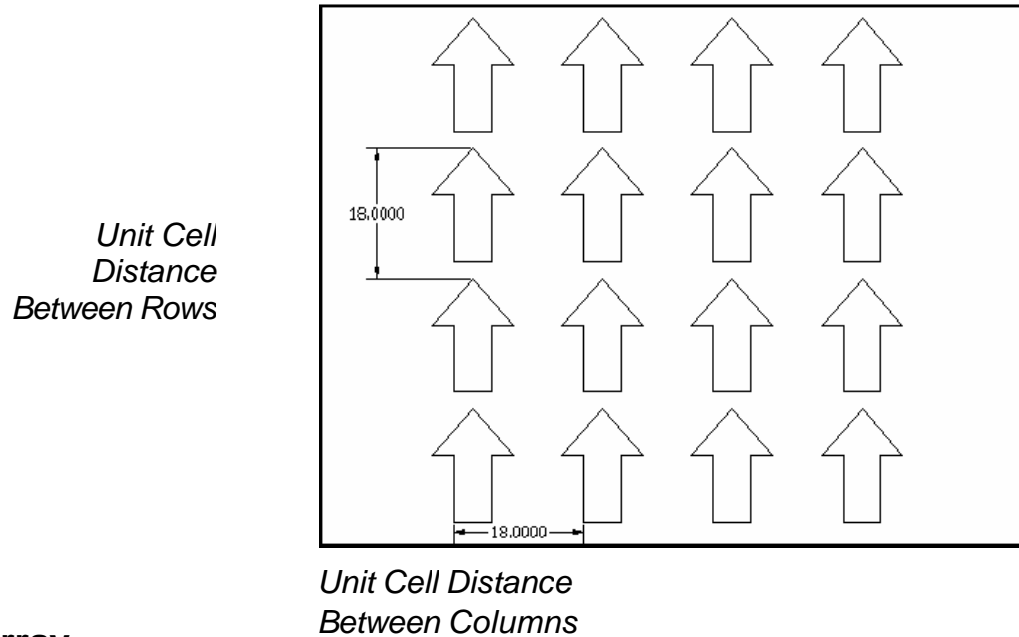

Polar Array

To draw a polar array:

1. **Choose** Modify, ARRAY.
or
2. **Click** the Arrayicon. 
or
3. **Type** *ARRAY at the command prompt. Command: **ARRAY***
4. **Pick** Objects to array. Select
objects:(**select**)
5. **Type** P to draw a polar array. Rectangular or Polararray
(R/P): **P**
6. **Pick** A center point for the array. Center point of array: **pick point**
7. **Type** The TOTAL number of items in the array. *Number of items: **number***
8. **Type** The number of degrees to rotate the objects. Degrees to fill (+=CCW, -=CW)<360>:
number

AutoCAD 2D Tutorial

9. **Type**

Yes or No to rotate objects.

Rotate objects as they are copied? <y> **Y or N**

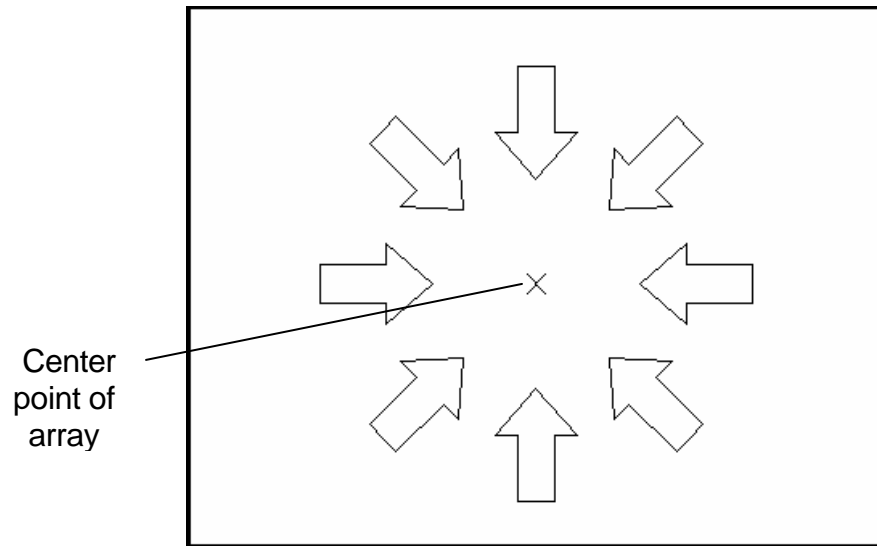
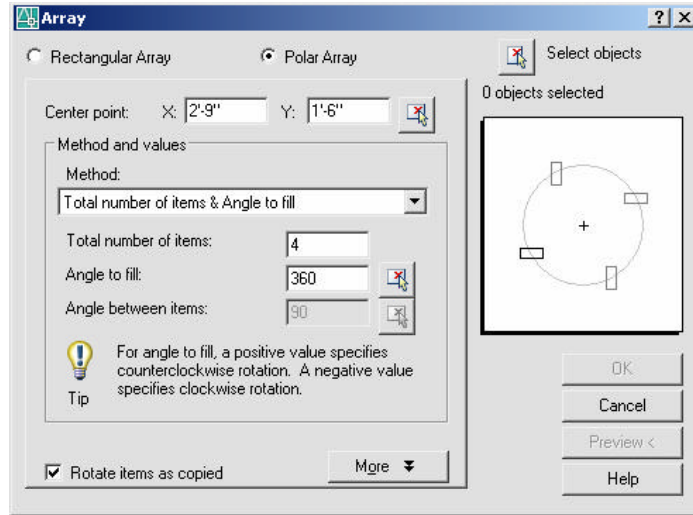

AutoCAD 2D Tutorial

Lengthen 13.6

1. **Choose** Modify, LENGTHEN.

o
r

2. **Type** LENGTHEN at the command prompt. Command: **_lengthen**

Select an object or [DElta/Percent/Total/
Enter delta length or [Angle] <0.0000>: **2**

Select an object to change or [Undo]: **pick object**

Object before lengthen

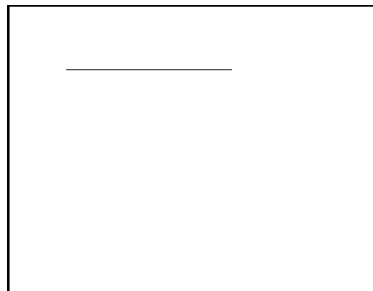

Object after lengthen



Chapter 14 Advanced Display Commands

AutoCAD 2D Tutorial

Transparent Commands 14.1

Transparent commands are those started while another is in progress. Precede transparent commands with an apostrophe.

- Type** LINE at the command prompt.
Command: **LINE**
Specify first point: **(pick point)**
Specify next point or [Undo]: **'zoom**
>>Specify corner of window, enter a scale factor (nX or nXP), or
[All/Center/Dynamic/Extents/Previous/Scale/Window]
<real time>: **(pick corner)**
>>>>Specify opposite corner: **(pick other corner)**

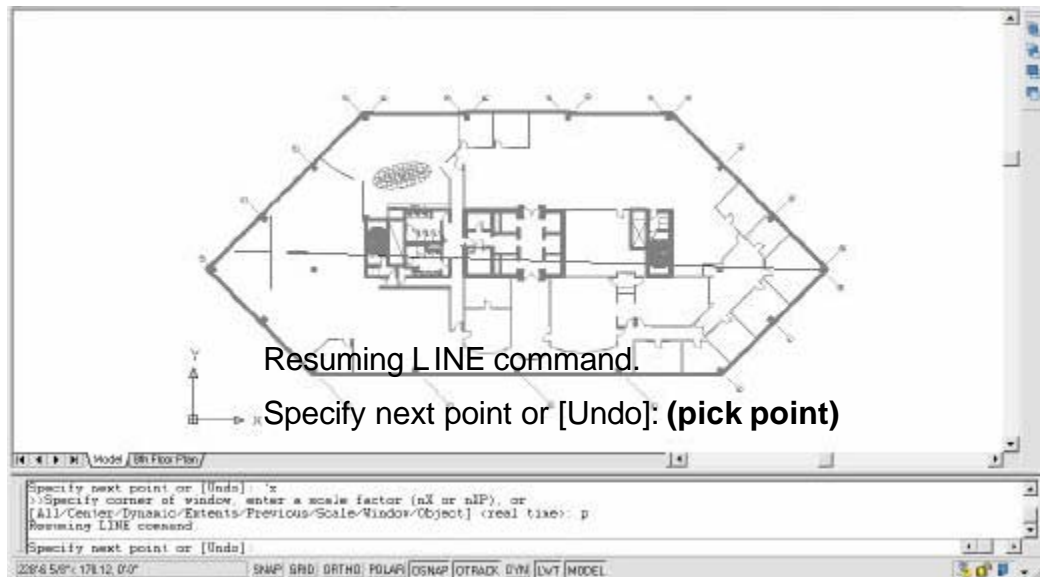

TIP:

Commands that do not select objects, create new objects, or end the drawing session usually can be used transparently.

AutoCAD 2D Tutorial

Multiple Command 14.2

Multiple repeats the specified command until canceled

If you want to repeat a command that you have just used, press ENTER or SPACEBAR, or right-click your pointing device at the Command prompt.

You also can repeat a command by entering multiple, a space, and the command name, as shown in the following example:

1. **Type** **MULTIPLE** before each command

Command: multiple circle

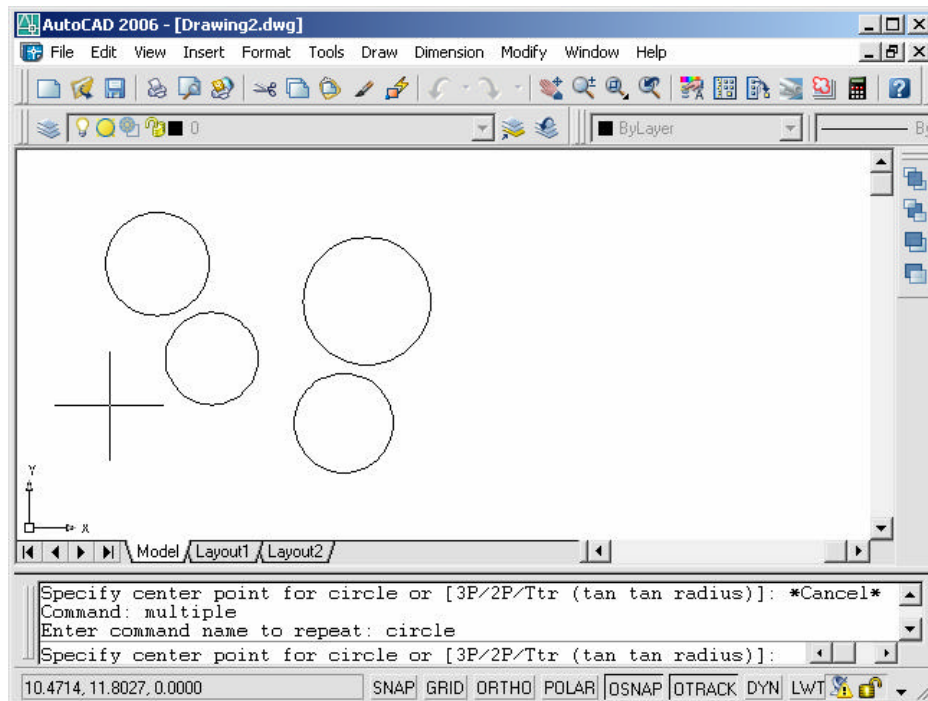

AutoCAD 2D Tutorial

Calculator (CAL Command) 14.3

Evaluates mathematical and geometric expressions

- Type** CAL at the command prompt. Command: **cal**
(or 'cal) Initializing...>>
Expression: **1+1**
2

Numeric operators

- ()** Groups expressions
- ^** Indicates exponentiation
- *, /** Multiplies, divides
- +, -** Adds, subtracts

Vector operators

- ()** Groups expressions
- &** Determines the vector product of vectors (as a vector)
 $[a,b,c]&[x,y,z] = [(b*z) - (c*y) , (c*x) - (a*z) , (a*y) - (b*x)]$
- *** Determines the scalar product of vectors (as a real number)
 $[a,b,c]*[x,y,z] = ax + by + cz$
- *, /** Multiplies, divides a vector by a real number a^*
 $[x,y,z] = [a*x,a*y,a*z]$
- +, -** Adds, subtracts vectors (points)
 $[a,b,c] + [x,y,z] = [a+x,b+y,c+z]$

AutoCAD 2D Tutorial

Converts units of measure

- Type** CAL at the command prompt.
Command: **cal(or 'cal)**
Initializing...>> Expression: **cvunit(1,inch,cm)**
2.54

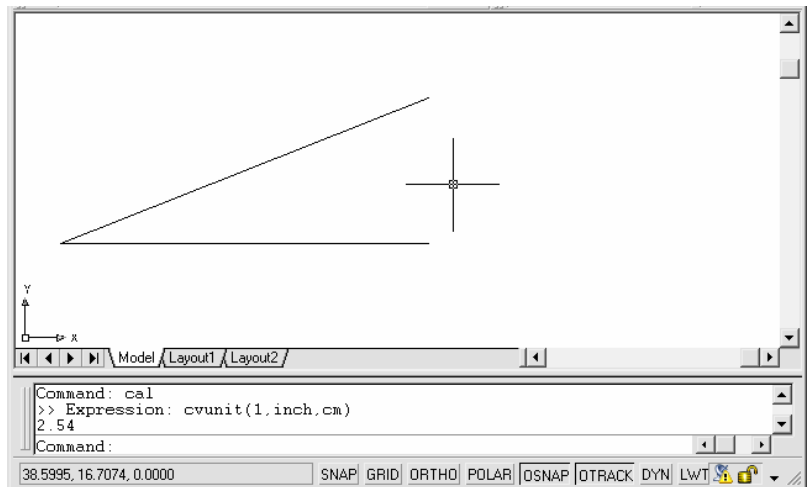

Determines Angles

- Type** CAL at the command prompt.
Command: **cal(or 'cal)**
Initializing...>> Expression: **ang(end,end,end)**
45

Chapter 15 Polylines

AutoCAD 2D Tutorial

Pline Command 15.1

A polyline is a connected sequence of line segments created as a single object. You can create straight line segments, arc segments, or a combination of the two.

1. **Choose** Draw, Polyline.
or
2. **Pick** the Pline icon. 
3. **Type** PLINE at the command prompt
Command : **PLINE** or **PL**
4. **Pick** A point on the drawing to start the polyline
From point:(**select**)
5. **Type** One of the following options
Arc/Close/Halfwidth/Length/Undo/Width/<endpoint of line>:
or
6. **Pick** A point to continue drawing
Arc/Close/Halfwidth/Length/Undo/Width/<endpoint of line>: (**pick point**)

Polyline as one segment

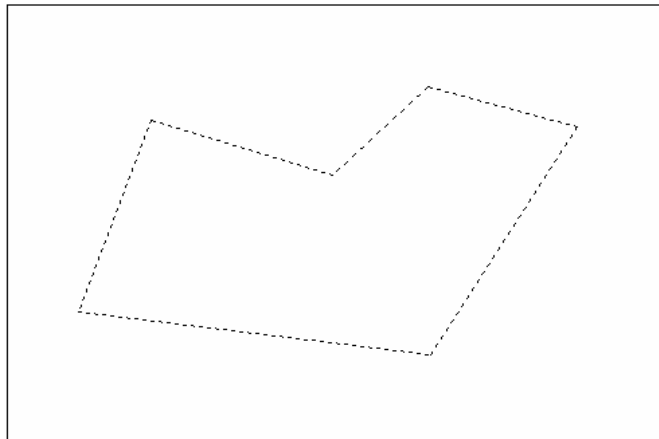

AutoCAD 2D Tutorial

PLINE options:

Arc	Toggles to arc mode and you receive the following: Angle/CENTER/Close/Direction/Halfwidth/Line/ Radius /Second Pt/Undo/Width/<endpt of arc>:
Close	Closes a polyline as it does in the line command.
Halfwidth	Specifies the halfwidth of the next polyline segments. Can be tapered.
Length	Specifies the length to be added to the polyline in the current direction.
Undo	Undoes the previous pline segment as with the line command.
Width	Specifies the width of the next polyline segments. Can be tapered.

Polyline with arcs

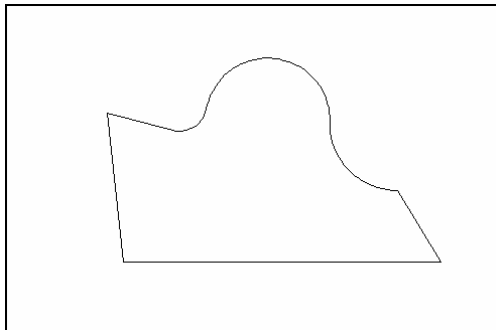

Polyline with width .125

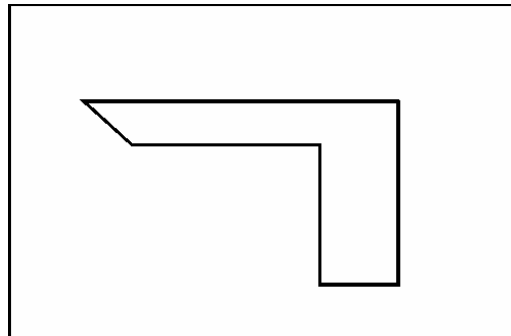

Tapered width polyline

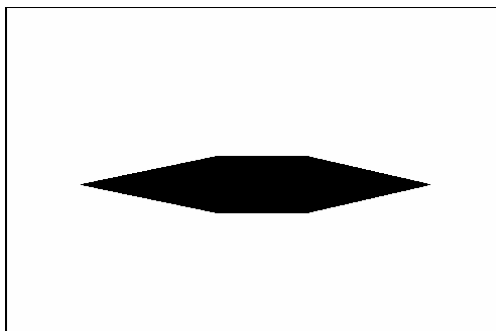

Tapered width arc polyline

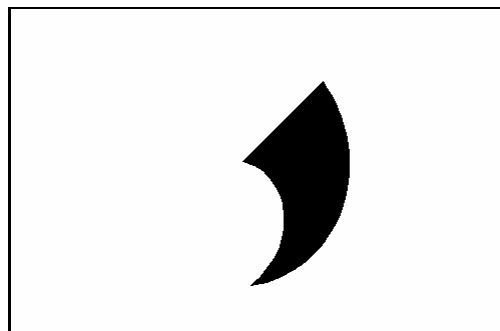

AutoCAD 2D Tutorial

Editing Polylines 15.2

1. **Choose** *Modify, Polyline.*
or
2. **Pick** the Pedit icon from the Modify II toolbar. 
3. **Type** PEDIT at the command prompt
Command: **PEDIT**
4. **Pick** Pick a polyline to edit
Select Polyline:(**pick**)
5. **Type** One of the following options:Close/Join/ Width/Edit vertex/FitCurve/Spline/Curve/Decurve/Undo/eXit

PEDIT options:

- Close** Closes open polyline segments
- Join** Connects polylines, lines, and arcs to existing polylines.
- Width** Changes the width for all polyline segments.
- Fit curve** Creates curved arc segments around pline vertices at the direction you specify.
- Spline Curve** Creates a curve through control points on a polyline.
- Decurve** Straightens curved segments.
- Edit Vertex** Displays the following Edit Vertex Options:

Polyline width change

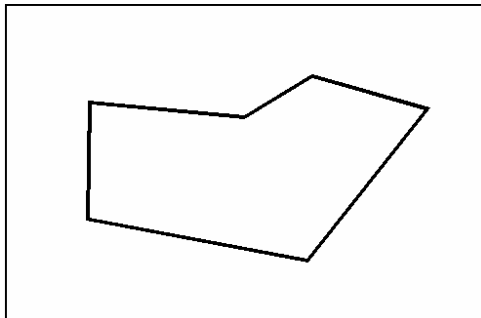

Splined Polyline

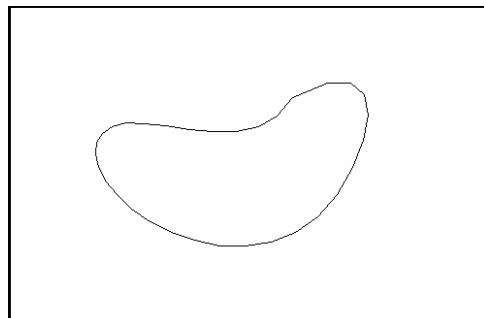

AutoCAD 2D Tutorial

PLINEGEN

Sets how linetype patterns are generated around the vertices of a two-dimensional polyline. Does not apply to polylines with tapered segments.

- 0** Polylines are generated to start and end with a dash at each vertex
- 1** Generates the linetype in a continuous pattern around the vertices of the polyline.

Edit Vertex Options

1. **Type** One of the following vertex options:
Next/Previous/Break/Insert/Move/Regen/Straighten/
Tangent/Width/eXit<N>:
 - Next** Moves the X to the next vertex
 - Previous** Moves the X to the previous vertex
 - Break** Remembers the currently marked vertex and allows you to move to another vertex. You can then remove the segments between these vertices. Closed plines will open.
 - Insert** Adds a new vertex after the currently marked vertex.
 - Move** Moves the location of the currently marked vertex.
 - Regen** Regenerates the pline. Used with the width option.
 - Straighten** Remembers the currently marked vertex and allows you to move to another vertex. You can then replace the segments between these vertices with a straight one.
 - Tangent** Attaches a tangent direction to the current vertex for later use in curve fitting.
 - Width** Changes starting and ending widths for the segment following the marked vertex.
 - eXit** Exits from editing vertices.

AutoCAD 2D Tutorial

Editing Multiple Polylines 15.3

1. **Type** the PEDIT at the command prompt. Command: **PEDIT**

Select polyline or [Multiple]:**M**

Pick multiple polylines to edit.

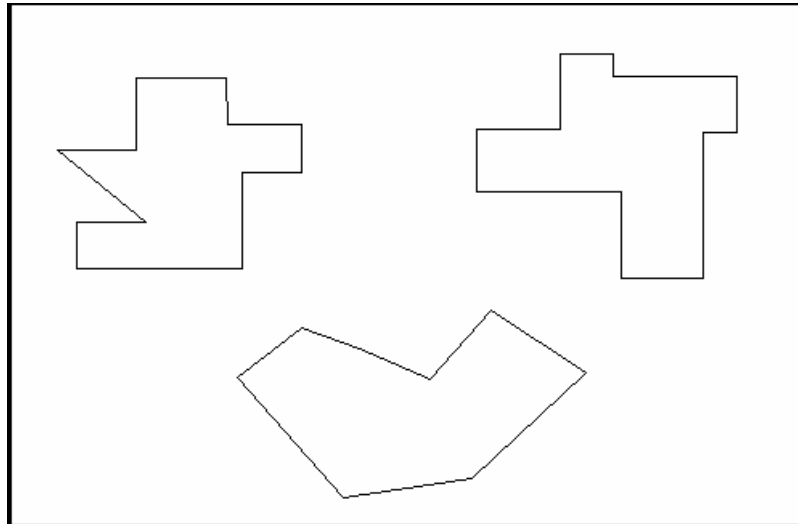

AutoCAD 2D Tutorial

Explode Command 15.4

1. **Choose** *Modify, Explode.*
or
2. **Pick** the Explode icon. 
3. **Type** EXPLODE at the command prompt.
Command: **EXPLODE**
or
4. **Pick** The object to explode. Select objects: (**pick**)

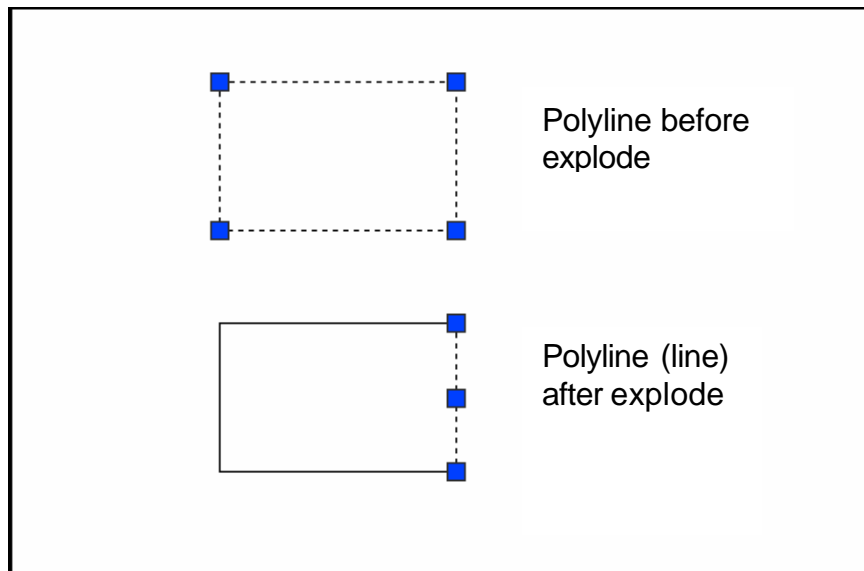

AutoCAD 2D Tutorial

Turning Lines into Polylines 15.5

Use the PEDIT command to pick lines. AutoCAD will ask if you want to turn these lines into polylines. You can then use the JOIN option under PEDIT to join additional lines to the polyline.

1. Command: **pedit**
Select polyline or [Multiple]: **pick line**
Object selected is not a polyline
Do you want to turn it into one? <Y>
Enter an option [Close/Join/Width/Edit
vertex/Fit/Spline/Decurve/Ltype gen/Undo]: j

TIP:

- Lines and Arcs must have a common endpoint to join them together.

Chapter 16

More Draw Commands

AutoCAD 2D Tutorial

Polygon 16.1

1. **Choose** Draw, Polygon.
or
2. **Click** the Polygon icon. 
or
3. **Type** Polygon at the command prompt.
Command: **POLYGON**
4. **Type** The number of sides for the polygon
(3-1024)
Number of sides <default>: **number**
5. **Pick** The center of the polygon. Edge/<Center of polygon>:
pick
or
6. **Type** **E** to define the polygon by two edges.
7. **Type** **I** or **C** to place the polygon inside or outside of an imaginary circle. Inscribed in circle/Circumscribed about circle (I/C):

Polygon Inscribed in an imaginary circle

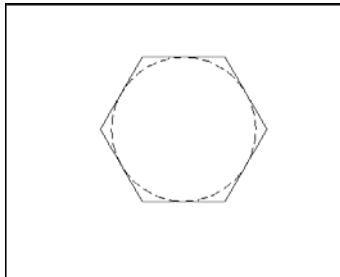

Polygon drawn with Edge

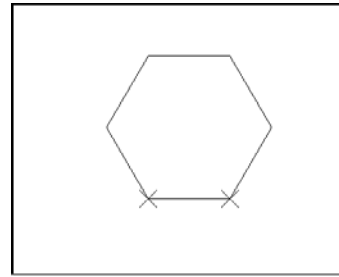

Polygon circumscribed around an imaginary circle

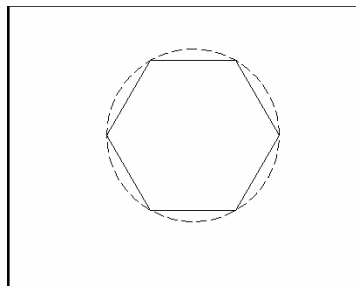

AutoCAD 2D Tutorial

Rectangle 16.2

1. **Choose** Draw, Rectangle.
or
2. **Click** the Rectangle icon. 
- or**
3. **Type** Rectang at the command prompt Command:
RECTANG Chamfer/Elevation/Fillet/Thickness/Width/
<First corner>:
4. **Pick** first corner.
5. **Pick** other corner or type coordinates (**i.e. @4,2**).

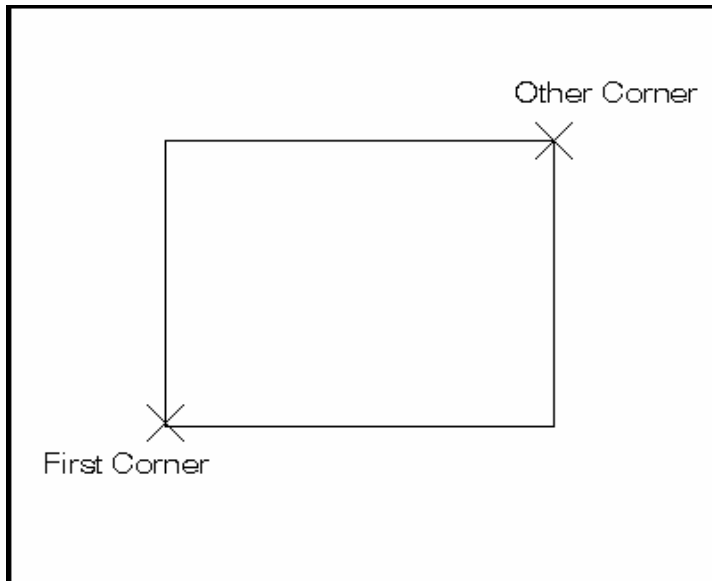

AutoCAD 2D Tutorial

Spline 16.3

The SPLINE command creates a particular type of spline known as a nonuniform rational B-spline (NURBS) curve. A NURBS curve produces a smooth curve between control points

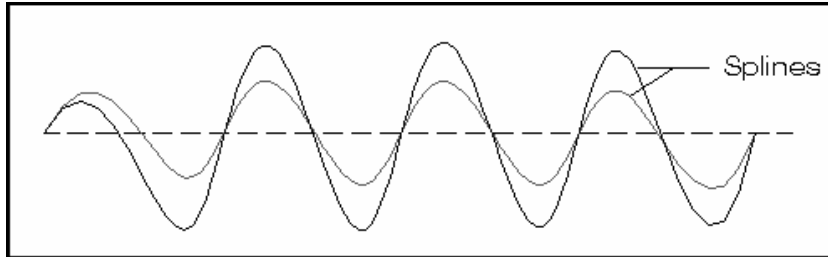

1. **Choose** Draw, Spline.
or
2. **Click** the Spline icon. 
or
3. **Type** SPLINE at the command prompt
Command: **SPLINE**
4. **Pick** A start point for the spline
Object / <Enter first point>: (**pick point**)
5. **Pick** Points until you are done drawing splines
Enter point: (**pick points**)
6. **Press** Enter or close to complete the spline
7. **Pick** Starting tangent point for the spline
Enter start tangent (**pick point**)
8. **Pick** Ending tangent point for the spline
Enter end tangent: (**pick point**)

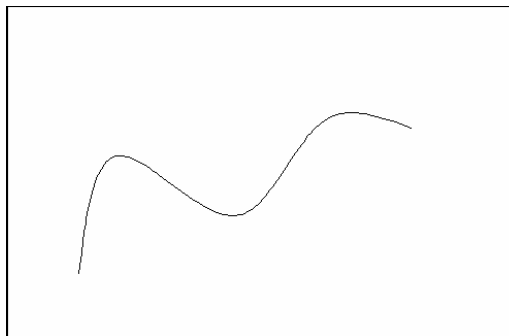

AutoCAD 2D Tutorial

Spline options:

Object	Converts 2D or 3D spline-fit polylines to equivalent Splines
Points	Points that define the spline
Close	Closes a spline.
Fit Tolerance	Allows you to set a tolerance value that creates a smooth spline.

TIP: Refer to AutoCAD online help topic for more information on spline options.

AutoCAD 2D Tutorial

Editing Splines 16.4

1. **Choose** Modify, Object, Spline.

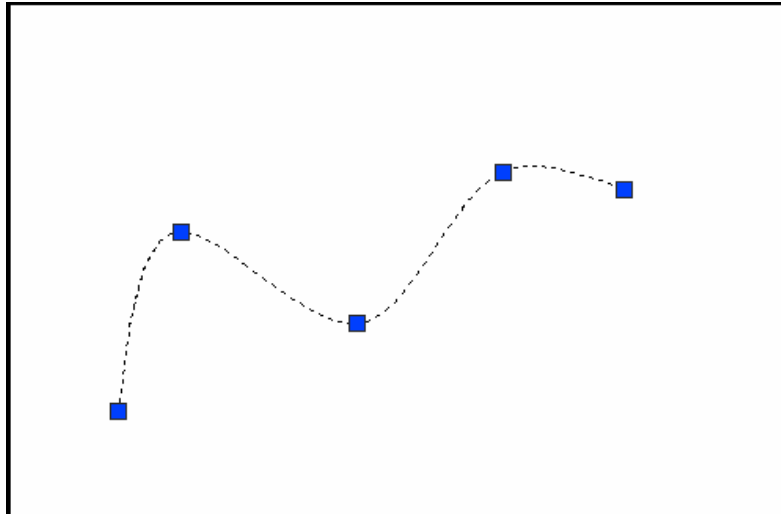

TIP: Drawings containing splines use less memory and disk space than those containing spline-fit polylines of similar shape.

AutoCAD 2D Tutorial

Covert PLINE to Spline 16.5

1. **Draw** a PLINE.
2. **Type** PEDIT to edit the polyline as a spline.
3. **Choose** Draw, Spline.
4. **Type** Object at the command prompt.
5. **Click** once on the polyline to turn it into a spline.

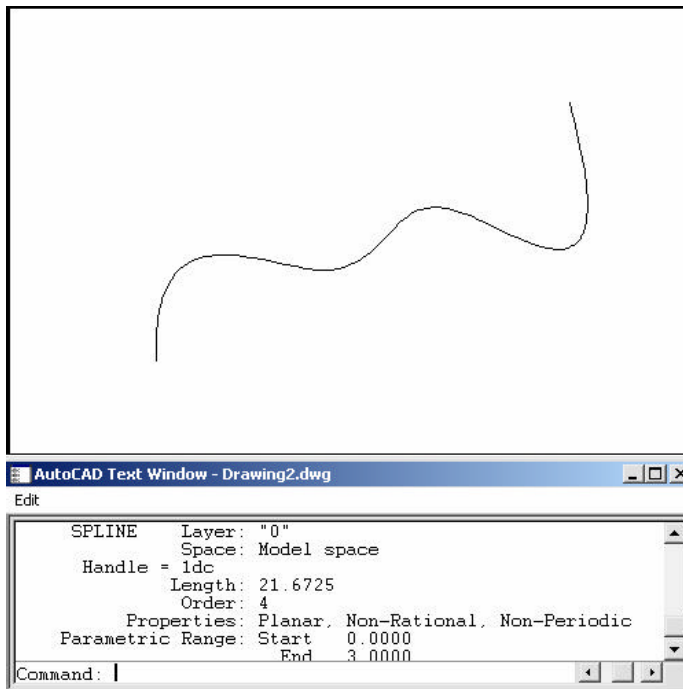

TIP: Use the LIST command to determine if an object is a PLINE or SPLINE.

AutoCAD 2D Tutorial

Donut 16.6

Donuts are filled rings or solid-filled circles that actually are closed polylines with width.

1. **Choose** Draw, Donut.
or
2. **Type** Donut at the command prompt.
Command: **DONUT**
3. **Type** A value for the inside diameter.
Inside diameter <last>: **.5**
4. **Type** A value for the outside diameter.
Outside diameter <last>: **1**
5. **Pick** A point for the center of the donut.
Center of doughnut: **(point)**

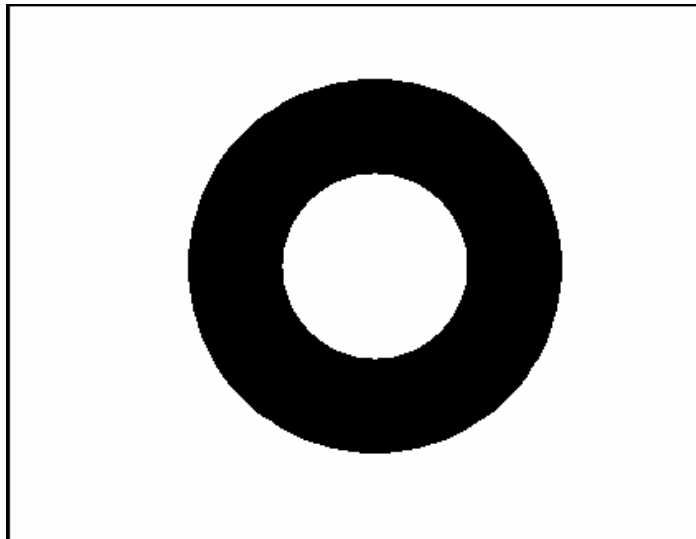

AutoCAD 2D Tutorial

Ellipse 16.7

Creates an ellipse or an elliptical arc.

1. **Choose** Draw, Ellipse.
or
2. **Choose** the Ellipse or Partial Ellipse icon. 
or
3. **Type** ELLIPSE at the command prompt
Command: **ELLIPSE**
4. **Type** One of the following options: Arc/Center/Isocircle /<Axis endpoint 1>:

Ellipse options:

- Axis endpoint 1** Defines the first axis by two specified endpoints. The angle of the first axis determines the angle of the ellipse. The first axis can define either the major or the minor axis of the ellipse.
- Axis endpoint 2:** <Other axis distance> / Rotation: Specify a point or enter a distance
- Arc** Creates an elliptical arc. The angle of the first axis determines the angle of the elliptical arc. The first axis can define either the major or the minor axis of the elliptical arc.
- Center** Creates the ellipse by a specified center point.
- Isocircle** Creates an isometric circle in the current isometric drawing plane.
- Rotation** The major axis is now treated as the diameter of a circle that will be rotated a specified amount around the axis. You enter an angle between 0 and 89.4 degrees.

AutoCAD 2D Tutorial

ELLIPSE,

Axis , Eccentricity (Axis Endpoint, Axis Endpoint, Other Axis Distance)

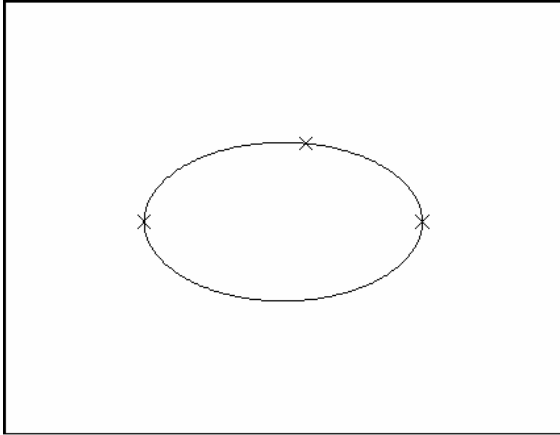

ELLIPSE,

Center, Axis, Axis

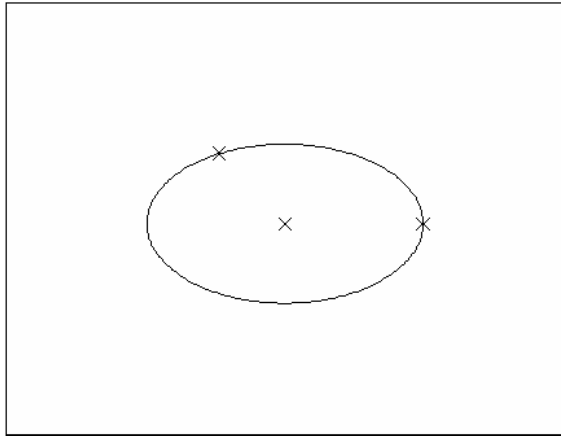

ELLIPSE,

Axis Endpoint, Axis Endpoint, Rotation=60

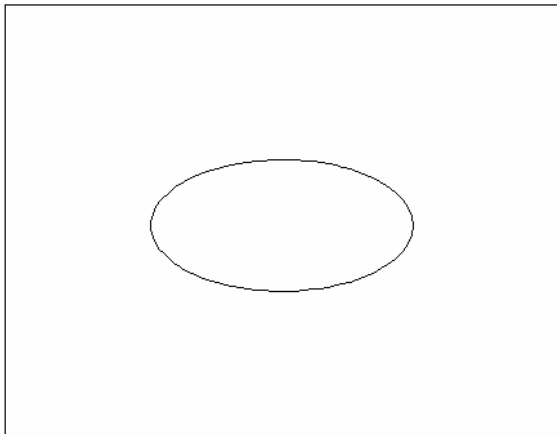

AutoCAD 2D Tutorial

Multilines 16.8

MLINE Command

Creates multiple parallel lines.

1. **Choose** Draw, Multiline.
or
2. **Type** MLINE at the command prompt.
Command: **MLINE**
3. **Pick** A point to start the multiline.
Justification/Scale/STyle/<From point>: pick point
4. **Pick** A second point to continue the multiline.
<To point>: **pick point**
5. **Pick** The next point to continue drawing multilines.
Undo/<To point>: pick point
6. **Press** ENTER to end the multiline
Close/Undo/<To point>: press enter or
7. **Type** C to close the multiline back to the first point.
Close/Undo/<To point>: **c**

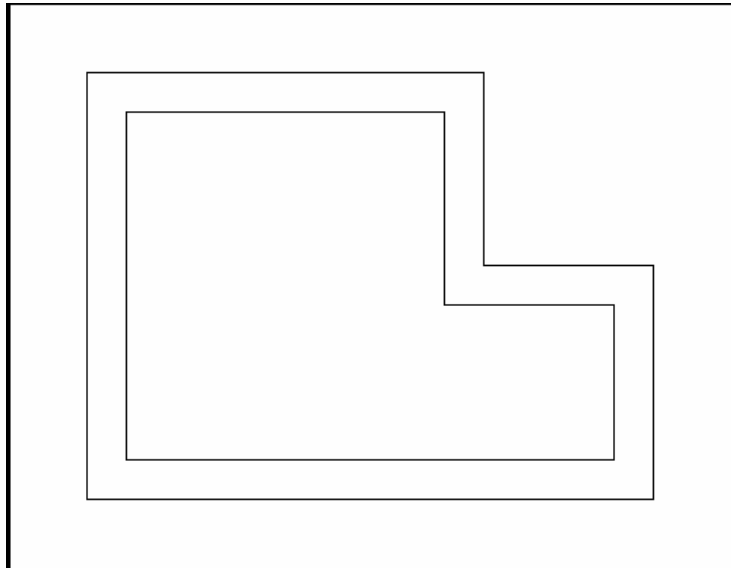

AutoCAD 2D Tutorial

Multiline Justifications

Top Justification

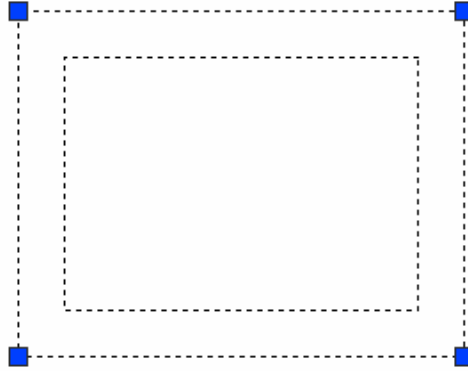

Bottom Justification

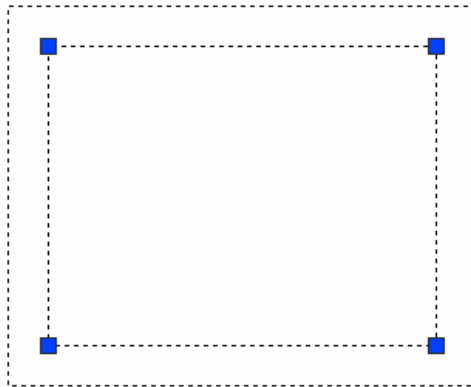

Zero Justification



AutoCAD 2D Tutorial

Multiline Styles 16.9

1. **Choose** Format, Multiline Style...
or
2. **Type** MLSTYLE at the command prompt.
Command: **MLSTYLE**
3. **Rename** The existing style called STANDARD to your newstyle.
4. **Choose** ElementProperties to change the appearance of the multilines.
5. **Choose** ADD to create the new multiline.

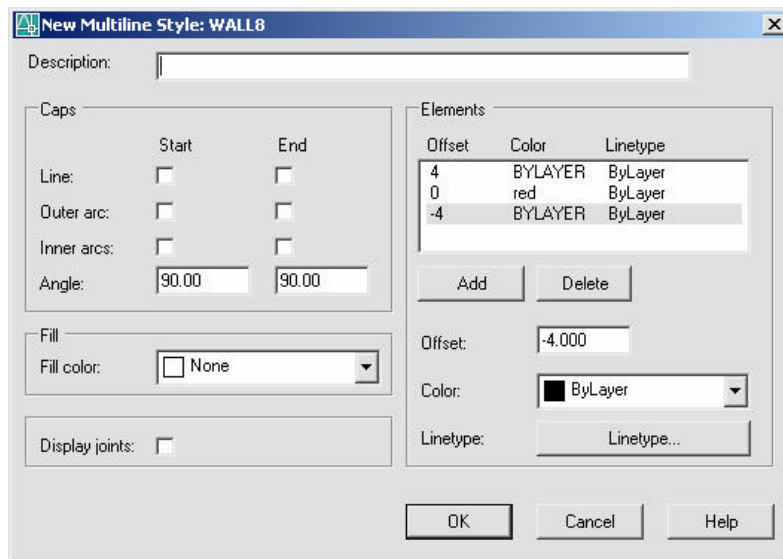
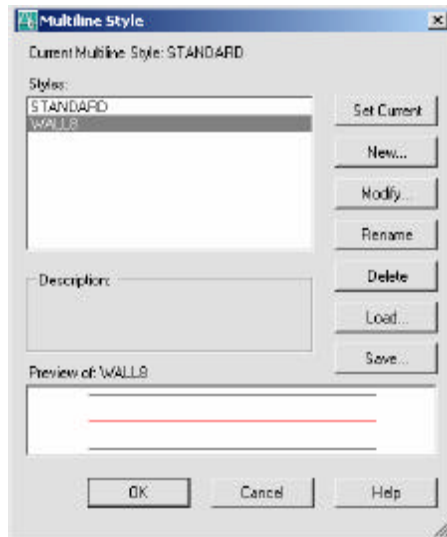

AutoCAD 2D Tutorial

Editing Multilines 16.10

1. **Choose** Modify, Multiline...
or
2. **Type** MLEDIT at the command prompt
Command: **MLEDIT**
3. **Choose** From one of the mledit options:

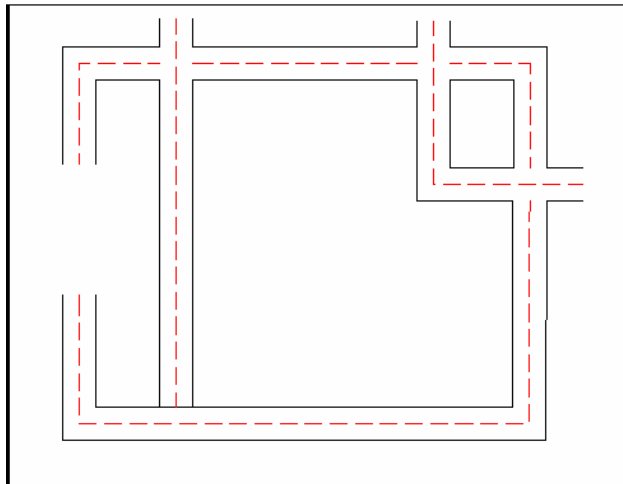
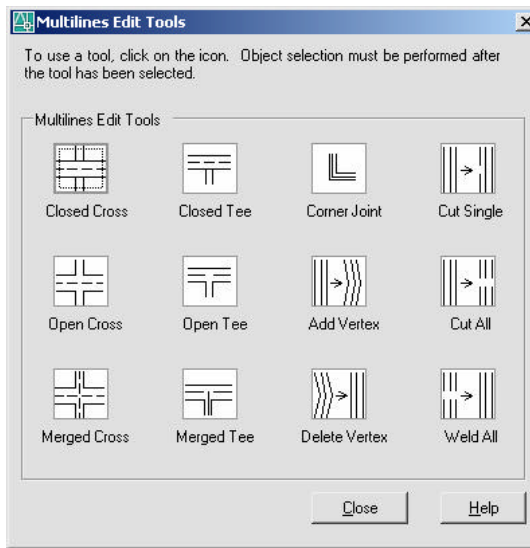

AutoCAD 2D Tutorial

Construction Line 16.11

Creates an infinite line.

1. **Choose** Draw, ConstructionLine
or
2. **Choose** the XLINE icon. 
or
3. **Type** XLINE at the command prompt.

Command: **XLINE**

Specify a point or [Hor/Ver/Ang/Bisect/Offset]:

XLINE Options

- HOR** Creates a horizontal xline passing through a specified point.
VER Creates a vertical xline passing through a specified point.
ANG Creates an xline at a specified angle.
BISECT Creates an xline that passes through the selected angle vertex and bisects the angle between the first and second line.
OFFSET Creates an xline parallel to another object.

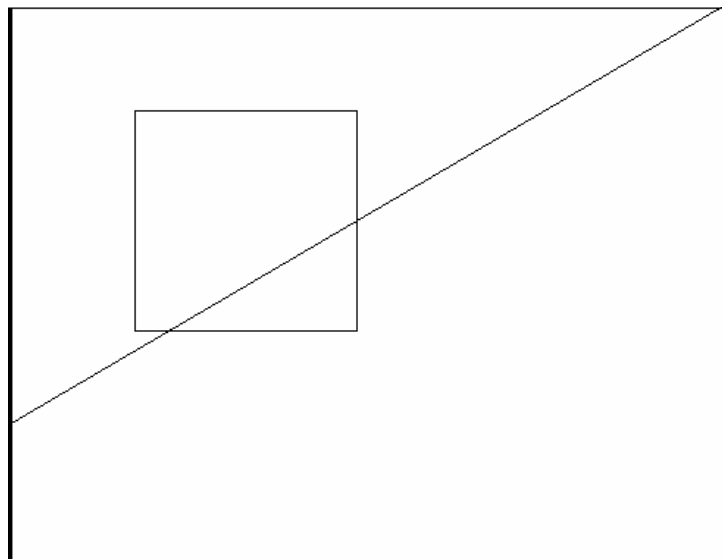

AutoCAD 2D Tutorial

Ray Command 16.12

Creates an infinite line in one direction.

1. **Choose** Draw, RAY
or
2. **Type** RAY at the command prompt.

Command: **RAY**

Specify a point : **(pick through point)**

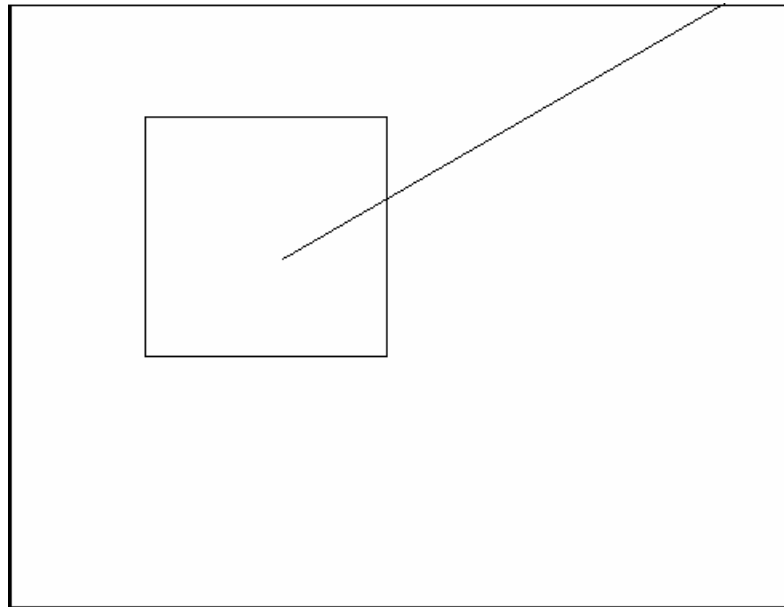

Chapter 17 Crosshatching

AutoCAD 2D Tutorial

BHATCH Command 17.1

1. **Choose** Draw, Hatch...
or
2. **Click** the Hatchicon. 
or
3. **Type** BHATCH at the command prompt
Command: **BHATCH**

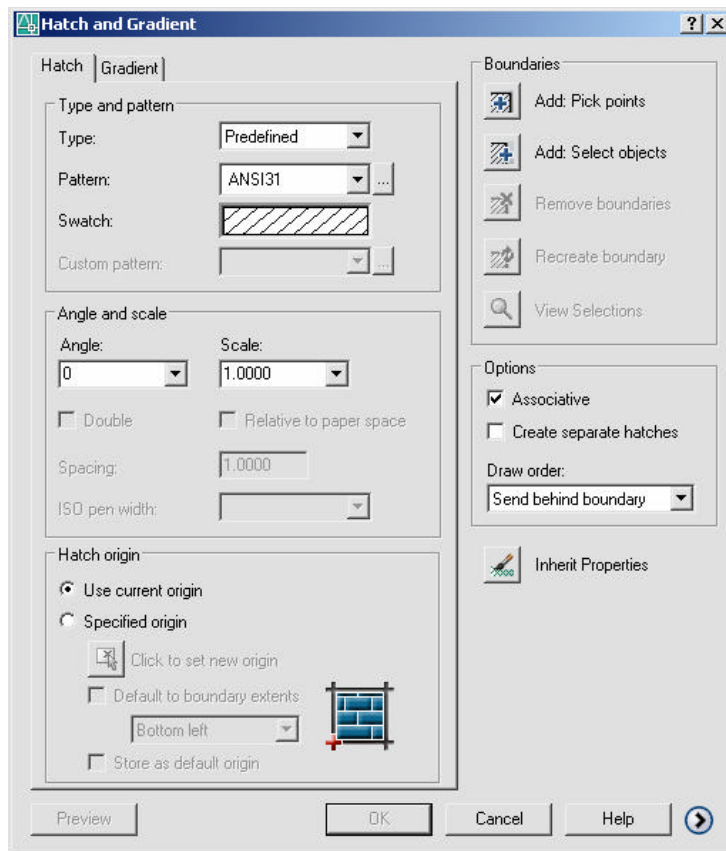

AutoCAD 2D Tutorial

BHATCHoptions:

Pattern Type	Sets the current pattern type by using AutoCAD's predefined patterns or user defined patterns.
Pattern Properties	Sets the current pattern, scale, angle, and spacing. Controls if hatch is double spaced or exploded.
Pick Points	Constructs a boundary from existing objects that form an enclosed area.
Select Objects	Selects specific objects for hatching. The Boundary Hatch dialog box disappears and AutoCAD prompts for object selection.
Inherit Properties	Applies the properties of an existing associative hatch to the current Pattern Type and Pattern Properties options.
Preview Hatch	Displays the hatching before applying it. AutoCAD removes the dialog box and hatches the selected areas.
Associative	Controls associative hatching.
Apply	Creates the crosshatching in the boundary.

AutoCAD 2D Tutorial

Advanced Hatch Options 17.2

1. **Choose** the **Advanced...** TAB from the BHATCH dialog.
2. **Choose** one of the following advanced options:

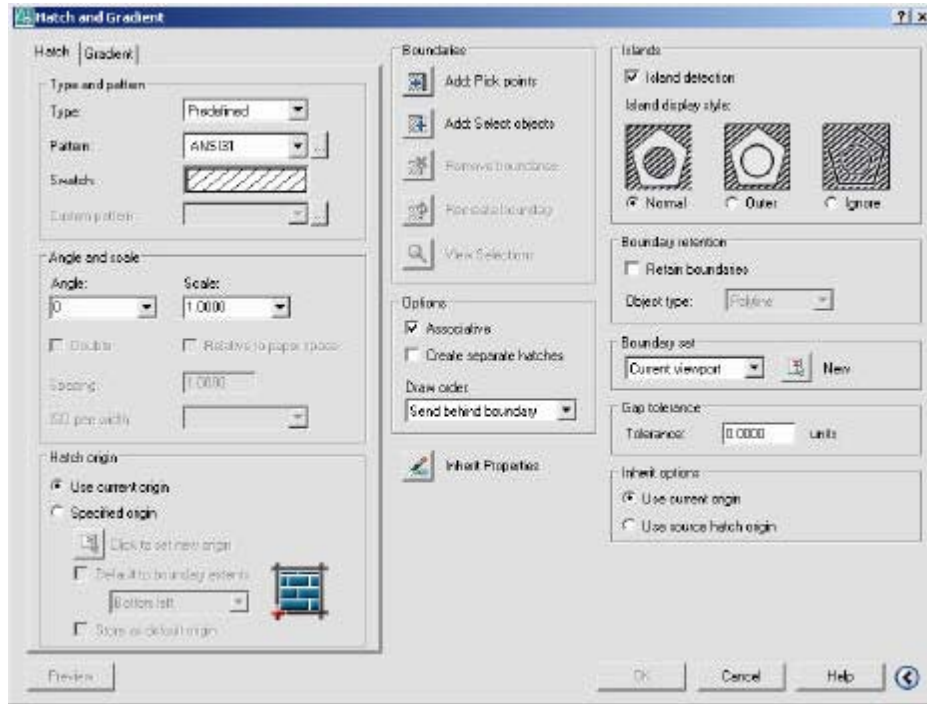

Define Boundary Set

Defines the set of objects AutoCAD analyzes when defining a boundary from a specified pick point.

Hatchstyle

Specifies the method used to hatch objects within the outermost hatch boundary. If there are no internal objects selected, specifying a hatching style has no effect.

Boundary Options

Specifies whether or not the temporary boundary objects will be added to the drawing.

AutoCAD 2D Tutorial

Gradient Hatch 17.3

1. **Choose** the **Gradient...** TAB from the BHATCH dialog.
2. **Choose** one of the following advanced options:

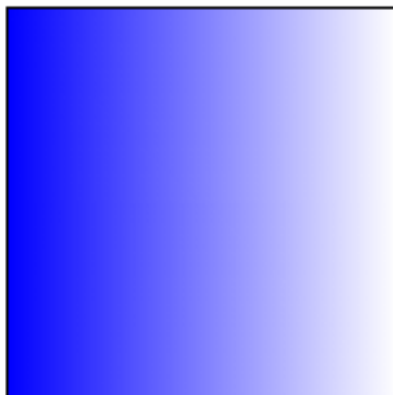
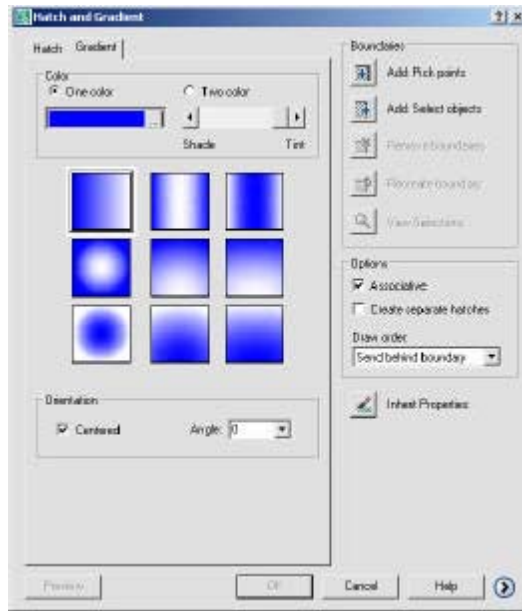

AutoCAD 2D Tutorial

HATCHEDIT 17.4

1. **Choose** Modify, Hatch...
or
2. **Click** the Hatch Edit icon from the Modify II toolbar. 
3. **Type** HATCHEDIT at the command prompt.
Command : **HATCHEDIT**
4. **Choose** One of the BHATCH options to modify.
5. **Pick** The OK button.

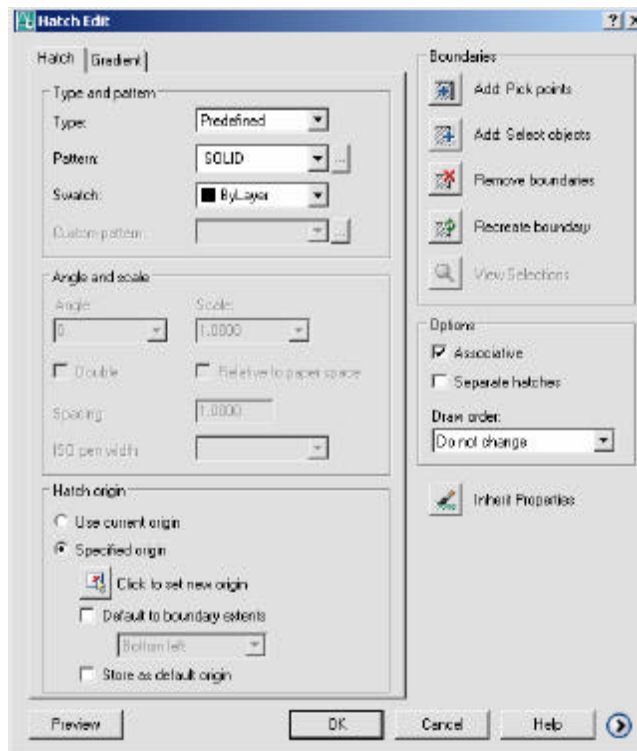

AutoCAD 2D Tutorial

Inherit Hatch 17.5

1. **Choose** Draw, Hatch...
or
2. **Click** the Hatchicon. 
or
3. **Type** BHATCH at the command prompt
Command: **BHATCH**
4. **Choose** InheritProperties.
5. **Pick** the crosshatch of an existing associative hatch to make the current Pattern Type and Pattern Properties options. Preview Hatch Displays the hatching before applying it.

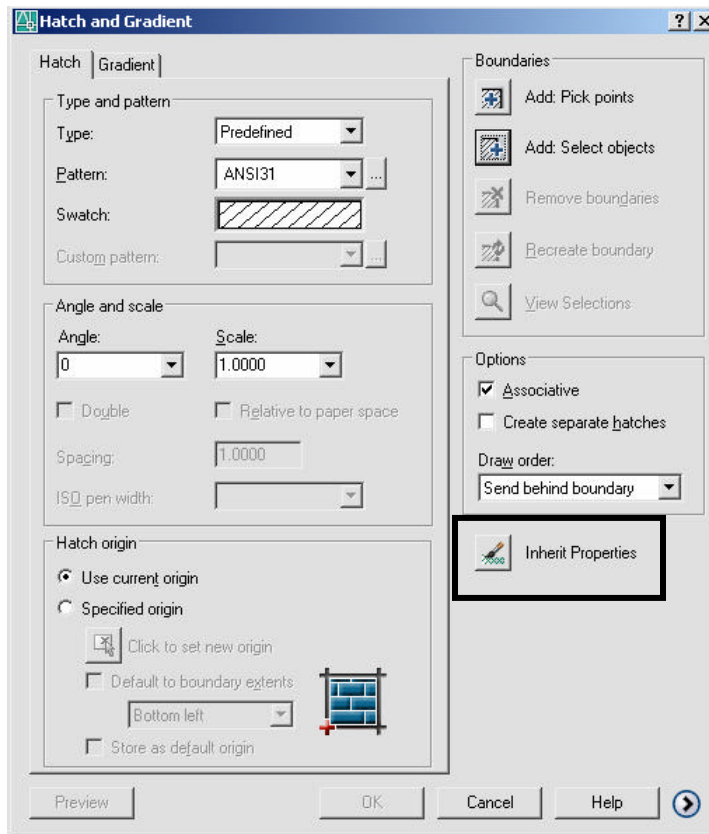

Chapter 18
Regions and Boundaries

AutoCAD 2D Tutorial

Boundary Command 18.1

Defines the object type, boundary set, and island detection method for defining boundaries from points you specify.

1. **Choose** Draw, Boundary
or
2. **Type** BOUNDARY at the command prompt.

Command: **BOUNDARY**

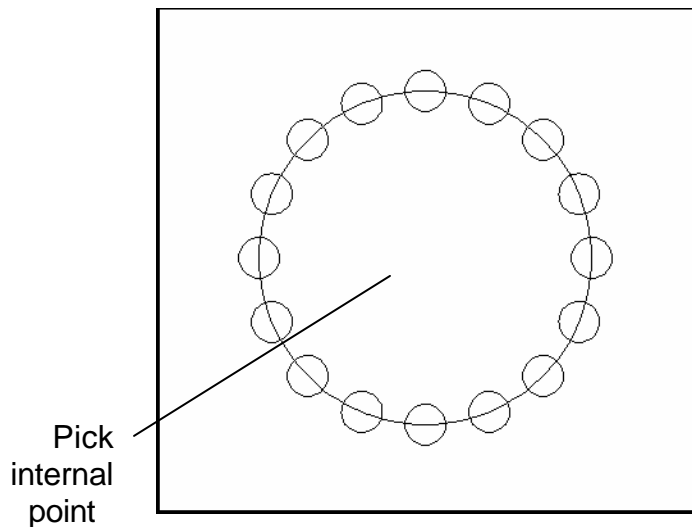
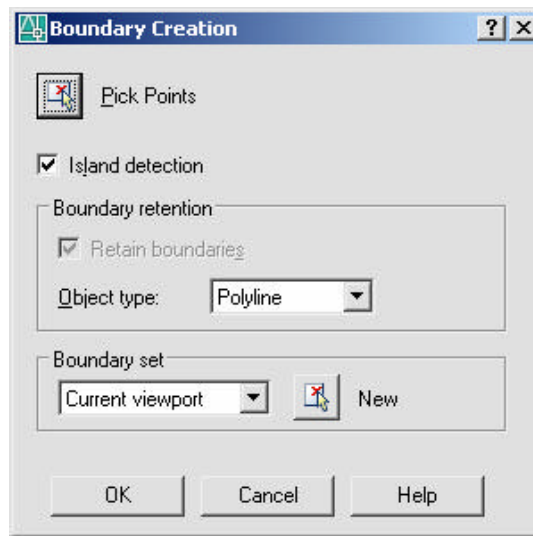

Boundary created

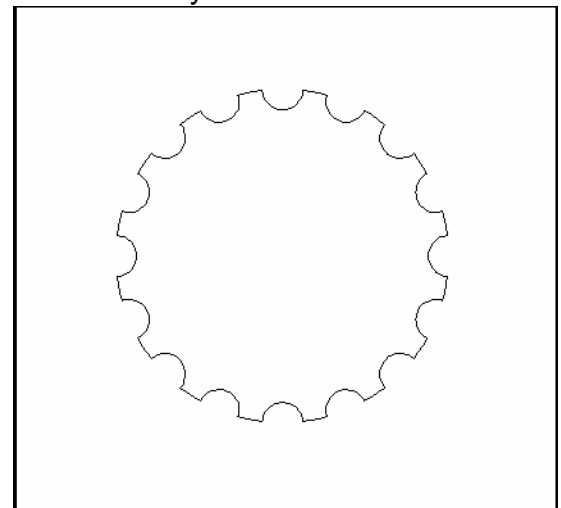

AutoCAD 2D Tutorial

Region Command 18.2

Regions are two-dimensional areas you create from closed shapes or loops. Closed polylines, lines, and curves are valid selections. Curves include circular arcs, circles, elliptical arcs, ellipses, and splines.

1. **Choose** Draw, Region
2. **Type** REGION at the command prompt.

Command: **REGION**

Select objects: **(pick boundary)**

Select objects:1 found

1 loop extracted.

1 Regioncreated.

Object created as a region

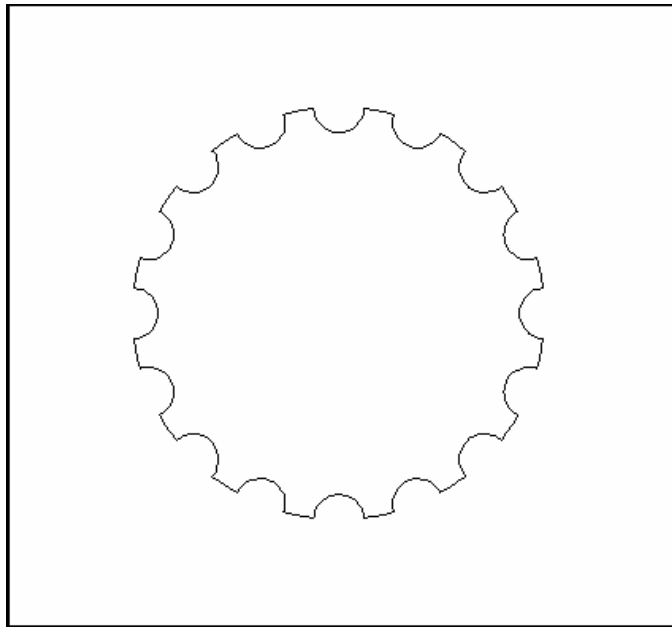

AutoCAD 2D Tutorial

Mass Properties 18.3

Calculates the mass properties of regions or solids.

1. **Choose** Tools, Inquiry, Region/Mass Properties
2. **Type** MASSPROP at the command prompt.
Command: **MASSPROP**
Select objects: **(pick region)**

----- **REGIONS** -----

Area:	11.1328
Perimeter:	16.3734
Bounding box:	X: 3.1508 -- 7.1352 Y: 2.8950 -- 6.8942
Centroid:	X: 5.1508 Y: 4.8946
Moments of inertia:	X: 276.6983 Y: 305.3510
Product of inertia:	XY: 280.6701
Radii of gyration:	X: 4.9854 Y: 5.2372

Principal moments and X-Y directions about centroid:
I: 9.9891 along [1.0000 0.0000] J: 9.9891 along
[0.0000 1.0000]

Write analysis to a file? [Yes/No] <N>:

Chapter 19

Blocks and Attributes

AutoCAD 2D Tutorial

Creating Local Blocks (BMAKE) 19.1

1. **Choose** Draw, Block, Make.
or
2. **Click** the Make Block icon. 
- or**
3. **Type** BMAKE at the command prompt.
Command: BMAKE or BLOCK
4. **Type** the name of the block.
5. **Pick** an insertion point.
6. **Select** objects to be included in the block definition.
7. **Click** OK.

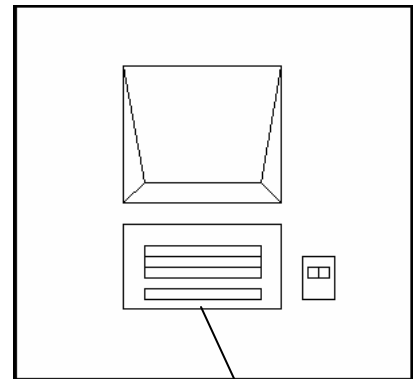
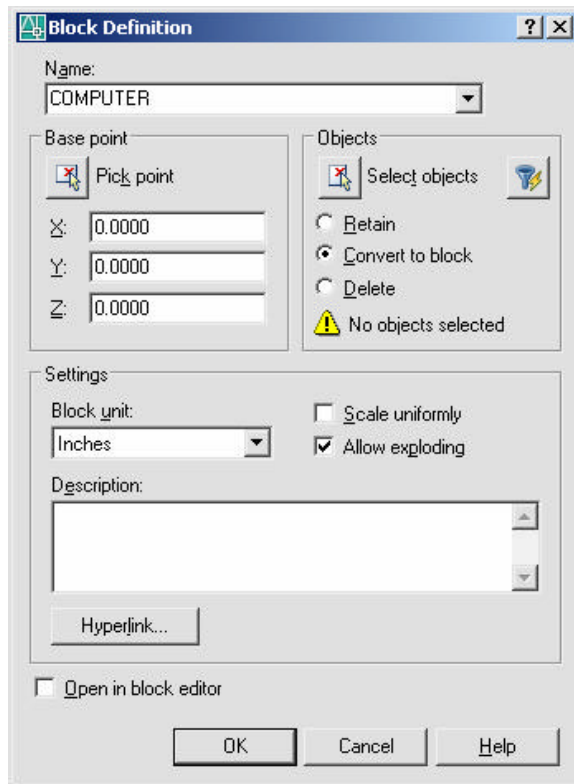

Insertion point

Note You cannot use DIRECT, LIGHT, AVE_RENDER, RM_SDB, SH_SPOT, and OVERHEAD as valid block names.

AutoCAD 2D Tutorial

Inserting Blocks 19.2

1. **Choose** Insert, InsertBlock or
2. **Click** the Insert icon from the INSERT toolbar. 
3. **Type** INSERT at the command prompt.
Command: **INSERT**
4. **Choose** the name to insert a local block and Browse... to insert a Wblock.
5. **Choose** the insertion point, scale, and rotation of the block.

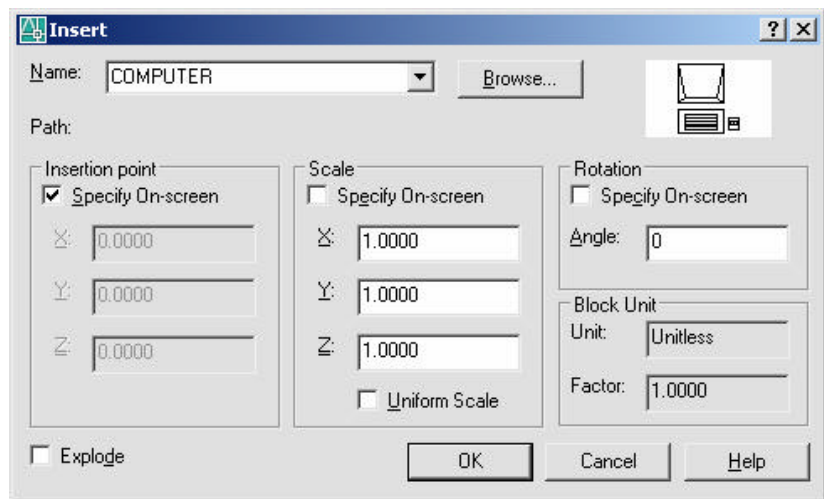

Block Inserted with a zero degree rotation angle

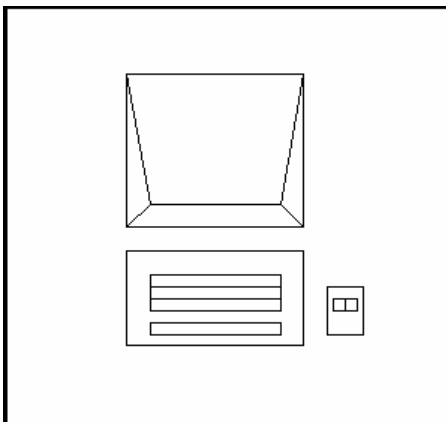

Block Inserted with a ninety degree rotation angle

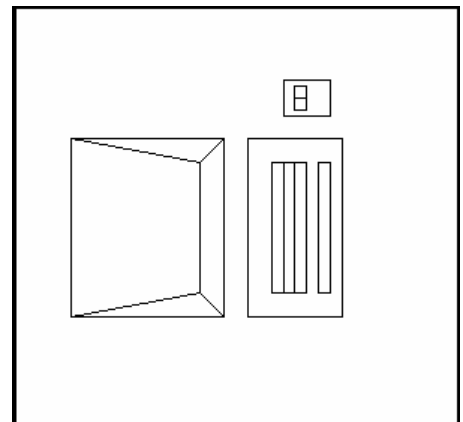

AutoCAD 2D Tutorial

Typing Insert (-INSERT)

1. **Type** - INSERT at the command prompt.
Command: **-INSERT**
2. **Type** Block name to insert.
Insert block name or (?) **type name**
3. **Pick** An insertion point. Insertion point: **pick point**
4. **Press** ENTER to keep the same x scale factor as the original block. X scale factor <1>Corner / XYZ:
5. **Press** ENTER to keep the same x scale factor as the original block.

Y scale factor (default=X):
6. **Press** ENTER to keep a rotation angle of zero. Rotation angle <0>:

or
7. **Pick** A rotation angle.

AutoCAD 2D Tutorial

Control the Color and Linetype of Blocks 19.3

The objects in an inserted block can retain their original properties, can inherit properties from the layer on which they are inserted, or can inherit the properties set as current in the drawing.

You have three choices for how the color, linetype, and lineweight properties of objects are treated when a block reference is inserted.

- Objects in the block do not inherit color, linetype, and lineweight properties from the current settings. The properties of objects in the block do not change regardless of the current settings.
- For this choice, it is recommended that you set the color, linetype, and lineweight properties individually for each object in the block definition: do not use BYBLOCK or BYLAYER color, linetype, and lineweight settings when creating these objects.
- Objects in the block inherit color, linetype, and lineweight properties from the color, linetype, and lineweight assigned to the current layer only.
- For this choice, before you create objects to be included in the block definition, set the current layer to 0, and set the current color, linetype, and lineweight to BYLAYER.
- Objects inherit color, linetype, and lineweight properties from the current color, linetype, and lineweight that you have set explicitly, that is, that you have set to override the color, linetype, or lineweight assigned to the current layer. If you have not explicitly set them, then these properties are inherited from the color, linetype, and lineweight assigned to the current layer.
- For this choice, before you create objects to be included in the block definition, set the current color or linetype to BYBLOCK.

If you want objects in a block to	Create objects on these layers	Create objects with these properties
Retain original properties	Any but 0 (zero)	Any but BYBLOCK or BYLAYER
Inherit properties from the current layer	0 (zero)	BYLAYER
Inherit individual properties first, then layer properties	Any	BYBLOCK

AutoCAD 2D Tutorial

Wblock Command 19.4

Writes objects to a new drawing file.

1. **Type** WBLOCK at the command prompt
 Command: **WBLOCK**
2. **Type** A drawing name (and location).
3. **Type** A block name if a local block already exists. Block name: **name**
 or
4. **Press** ENTER to create a block.
5. **Pick** An insertion point on the object
 Insertion base point: **pick a point**
6. **Pick** Objects to create the block.
 Select objects: **pick objects**
7. **Press** ENTER to end the selection set.

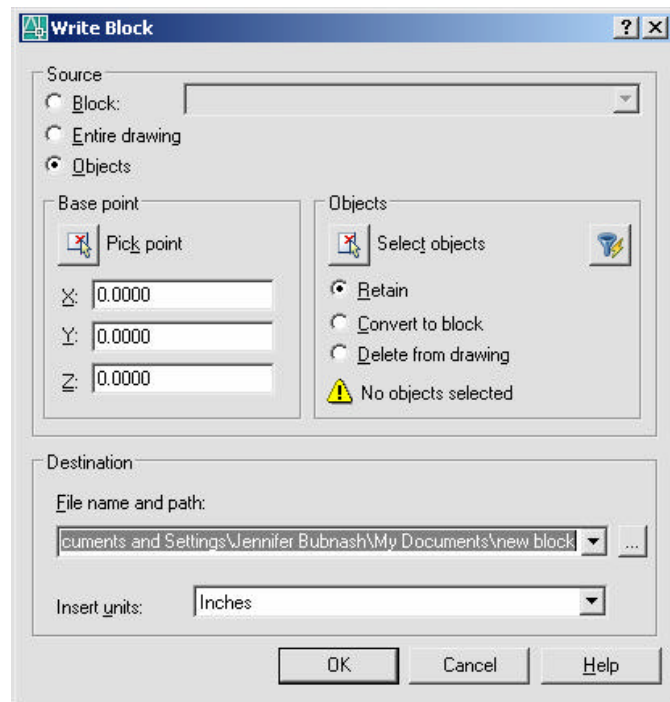

AutoCAD 2D Tutorial

Purge 19.5

1. **Choose** File, Drawing Utilities, Purge.
or
2. **Type** PURGE at the command prompt
Command: **PURGE**
3. **Choose** One of the following purge options:
Purge unused
Blocks/Dimstyles/LAyers/ LTypes/
SShapes/SStyles/Mlinestyles/All:

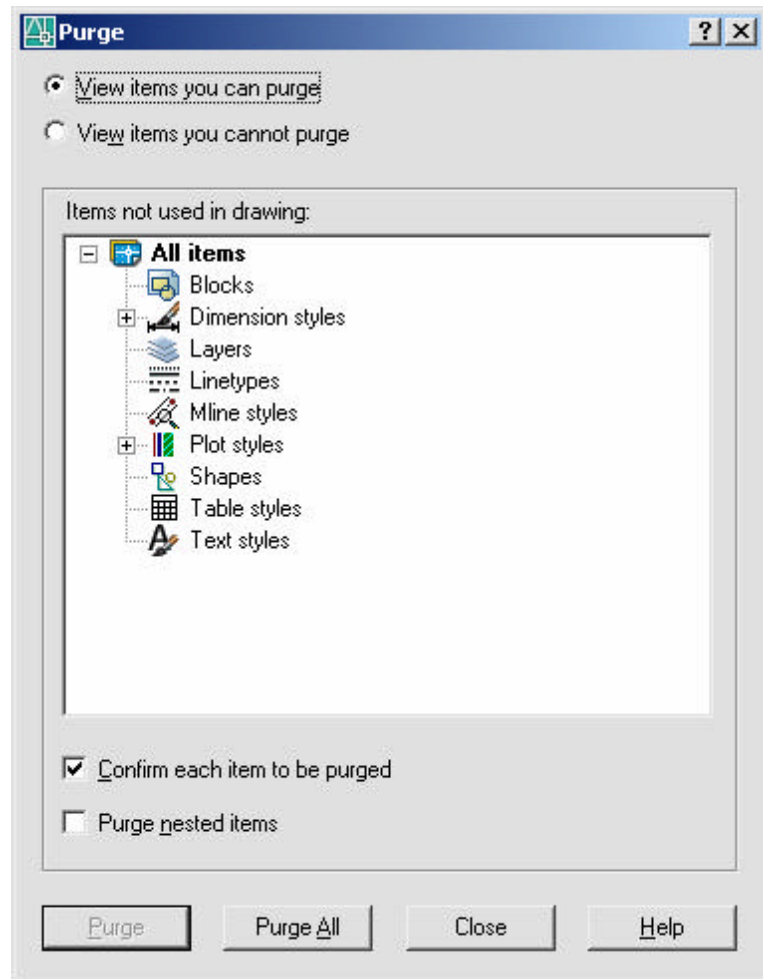

AutoCAD 2D Tutorial

Defining Attributes 19.6

1. **Choose** Draw, Block, Define Attributes...
or
2. **Type** ATTDEF at the command prompt. Command: **ATTDEF**
3. **Choose** TAG to specify each attribute occurrence in the drawing.
4. **Choose** Prompt to fill in the prompt that the user sees when placing the attribute.
5. **Choose** Value to fill in a default value.
6. **Pick** An insertion point for each attribute
7. **Create** A block which includes the new attributes.

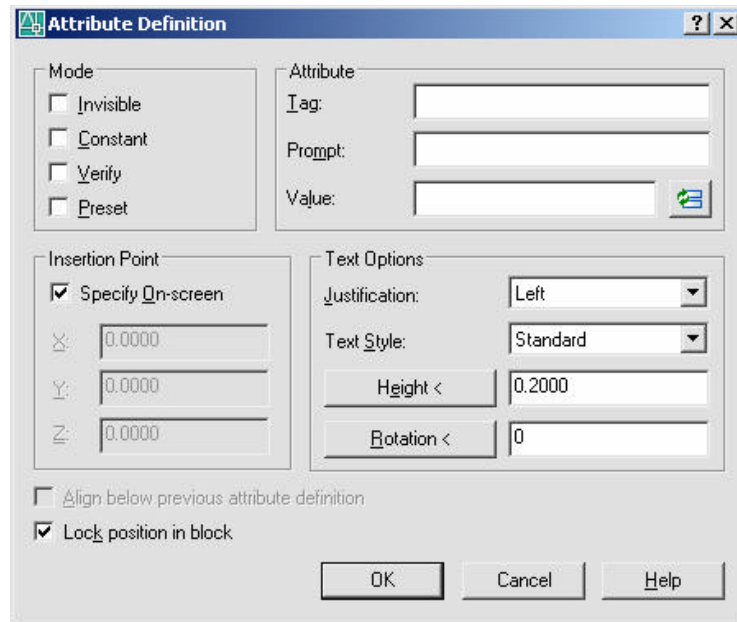

Toggle the following mode settings to on or off .

- Invisible** Does not display, but allows extraction.
- Constant** All occurrences of this Attribute have the same value.
- Verify** Issues extra prompts to verify a proper value.
- Preset** Does not prompt for this Attribute during Block insertion.

AutoCAD 2D Tutorial

Editing Attributes 19.7

1. **Choose** Modify, Object, Attribute, Single...
or
2. **Click** the Edit Attribute icon from the Modify II Toolbar. 
3. **Type** ATTEDIT at the command prompt
Command: **ATTEDIT**
4. **Pick** The block to edit
Select block: **pick**

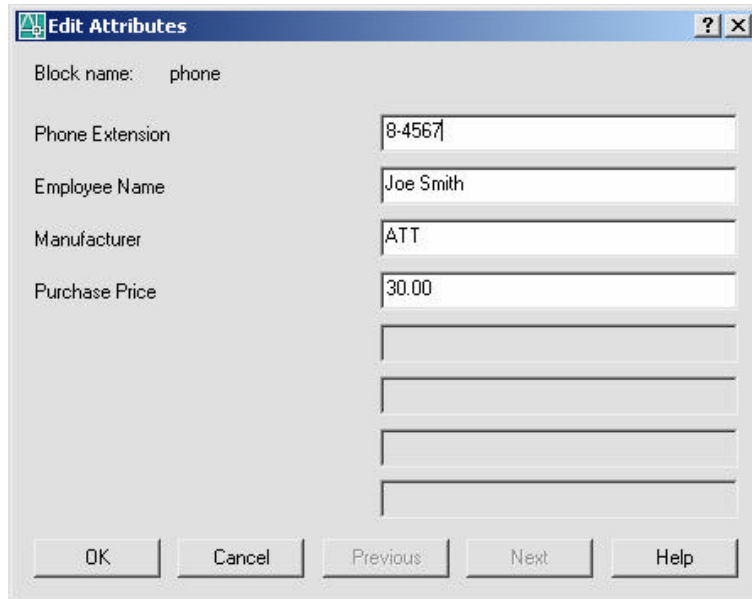

Block name: phone

Phone Extension: 8-4567

Employee Name: Joe Smith

Manufacturer: ATT

Purchase Price: 30.00

OK Cancel Previous Next Help

AutoCAD 2D Tutorial

Block Attribute Manager 19.8

1. **Open** a drawing with attributes.
2. **Type** BATTMAN at the command prompt.
Command: **BATTMAN**
or
3. **Choose** Modify, Object, Attribute, Block Attribute Manager
or
4. **Click** the Block Attribute Manager icon from the  Modify II Toolbar

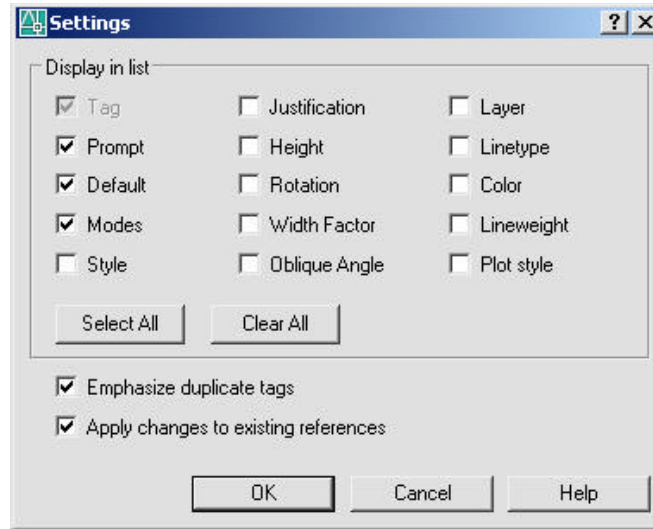
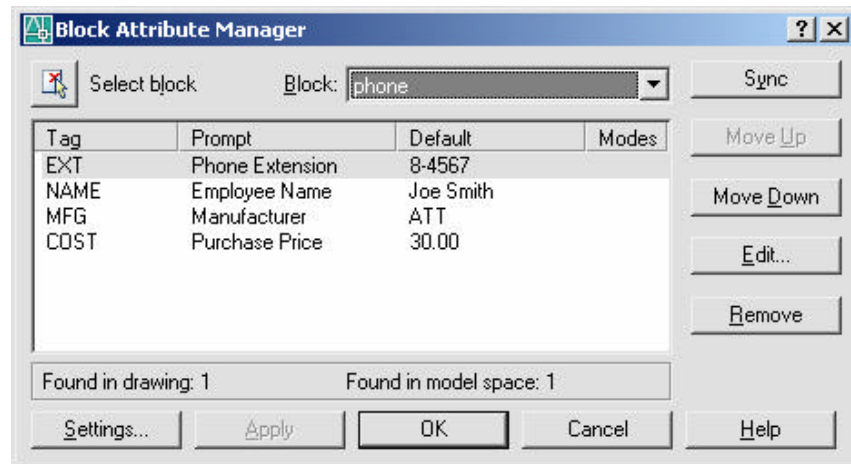

AutoCAD 2D Tutorial

Synchronize Attributes 19.9

Updates all instances of a specified block with the current attributes defined for the block

1. **Open** a drawing with attributes.
2. **Type** ATTSYNC at the command prompt.
Command:**ATTSYNC**
3. **Click** the Block Attribute Manager icon from the  Modify II toolbar.
4. **Press** Enter an option [?/Name/Select] <Select>:
enter and select a block with attributes.
5. **Press** ATTSYNC block computer? [Yes/No]<Yes>:
enter to synchronies. ATTSYNC complete.

AutoCAD 2D Tutorial

Enhanced Attribute Extract 19.10

The Editor enables you to edit the attributes in an individual block as opposed to the Block Manager which is used to Block Definitions.

1. **Open** a drawing with block attributes.
2. **Choose** Tools, Attribute Extraction...
or
3. **Click** the Attribute Extract icon from the Modify II toolbar. 
4. **Choose** the Current Drawing radio button and Next.

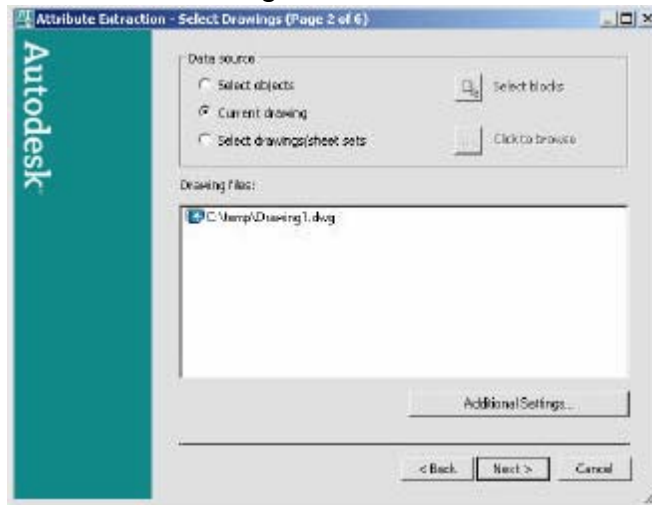

5. **Click** Next to choose Xrefs and nested blocks from the Settings window.
6. **Click** Next to not choose an existing template.
7. **Choose** the Blocks and Attributes to extract and Next.

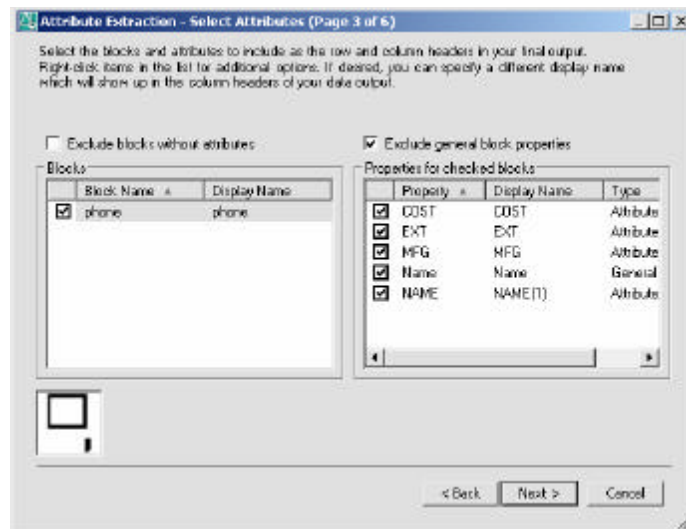

AutoCAD 2D Tutorial

8. **Choose** the View output.

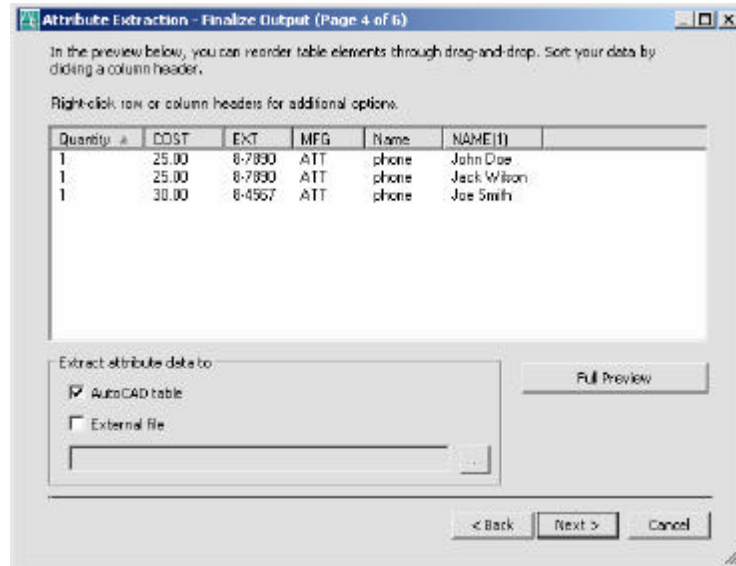

9. **Click** Next.
10. **Save** the file phone.xls
11. **Open** the template in Excel.

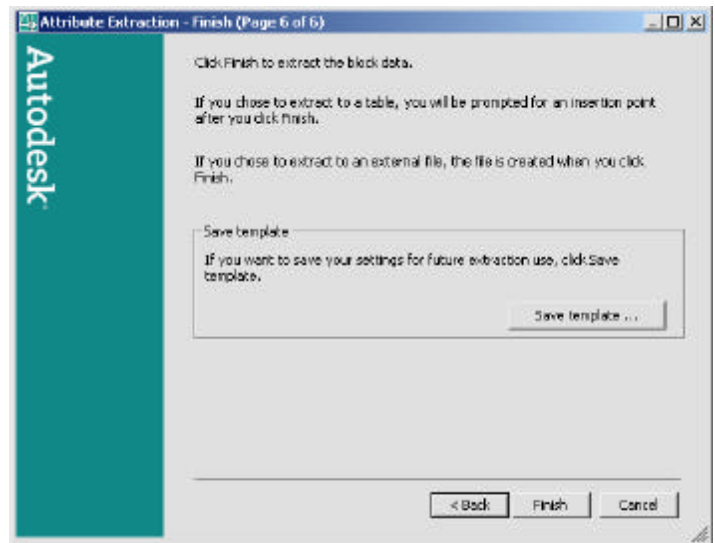
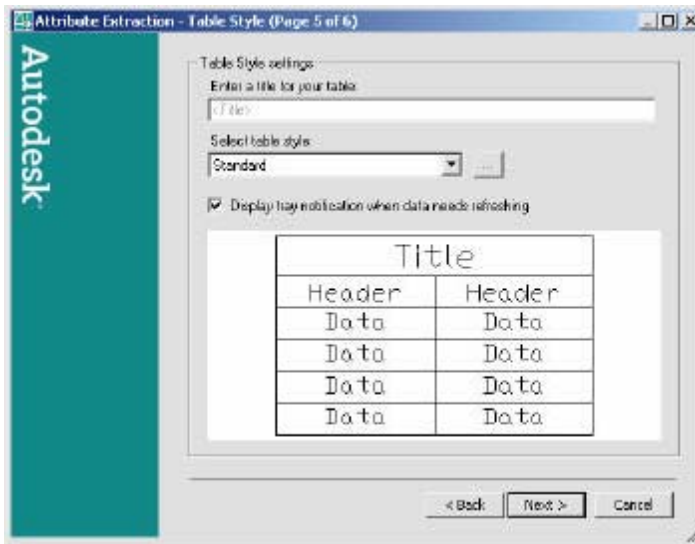

Chapter 20 **Design Center and Tool** **Palettes**

AutoCAD 2D Tutorial

Design Center Overview 20.1

The AutoCAD DesignCenter finds and transfers blocks, text styles, layers, dimensionstyles, etc from drawings, WEB

1. **Choose** Tools, AutoCAD DesignCenter.
or
2. **Press** **CTL+2** on the keyboard.
or
3. **Type** ADCENTER at the command prompt.
Command: **adcenter**

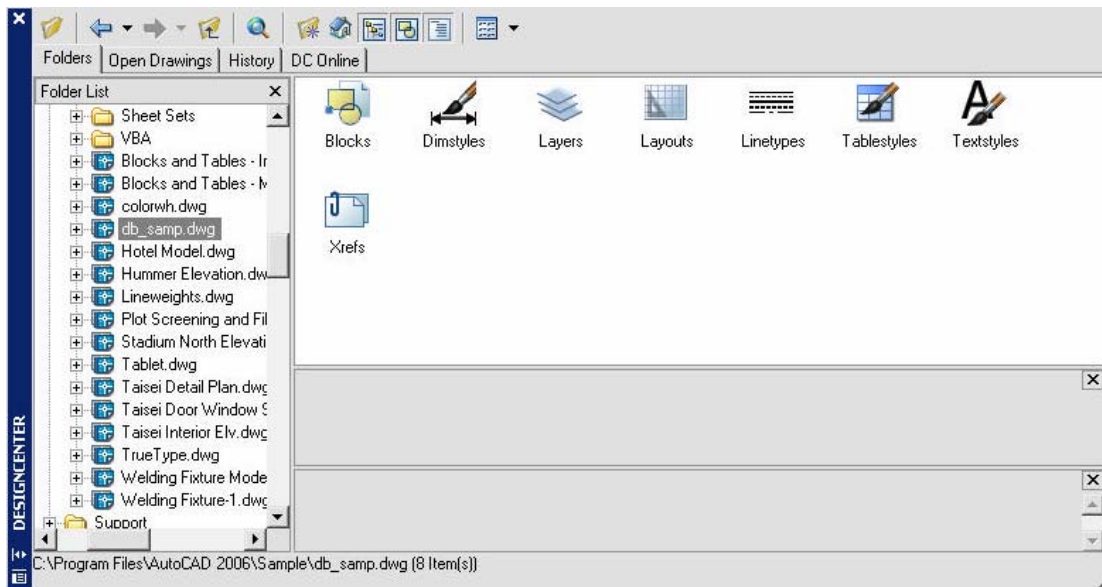

AutoCAD 2D Tutorial

Design Center Blocks 20.2

1. **Choose** Blocks  Blocks from one of the Design Center menus.
2. **Drag** and drop a block from the Design Center into a drawing.

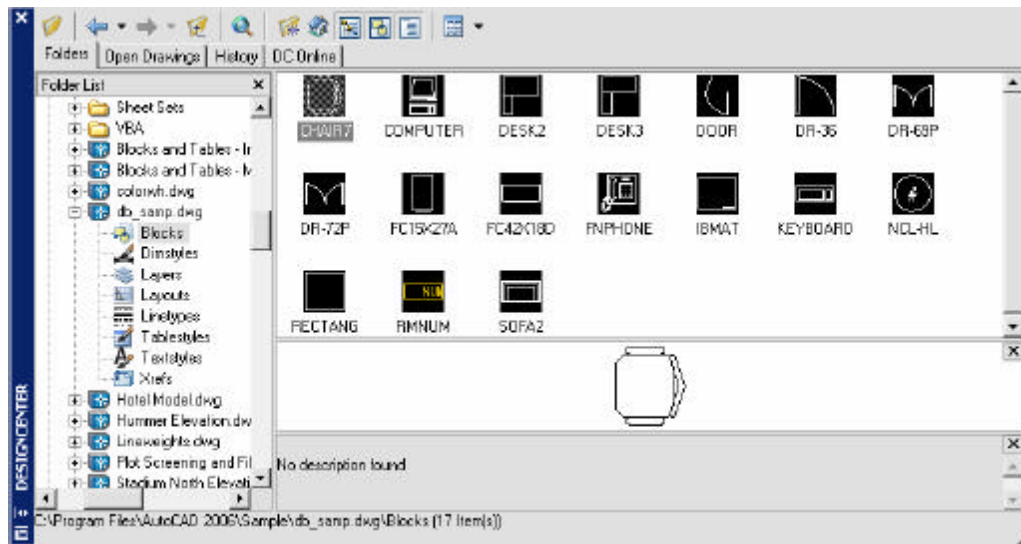

TIP:

- Blocks with attributes will be prompted as they are inserted into the drawing

AutoCAD 2D Tutorial

Hatching from the Design Center 20.3

1. **Choose** a crosshatch pattern from the following AutoCAD directory
\\AutoCADxxxx\Support\acad.pat or
\\AutoCADxxxx\Backup
2. **Drag** and drop a pattern into a drawing.

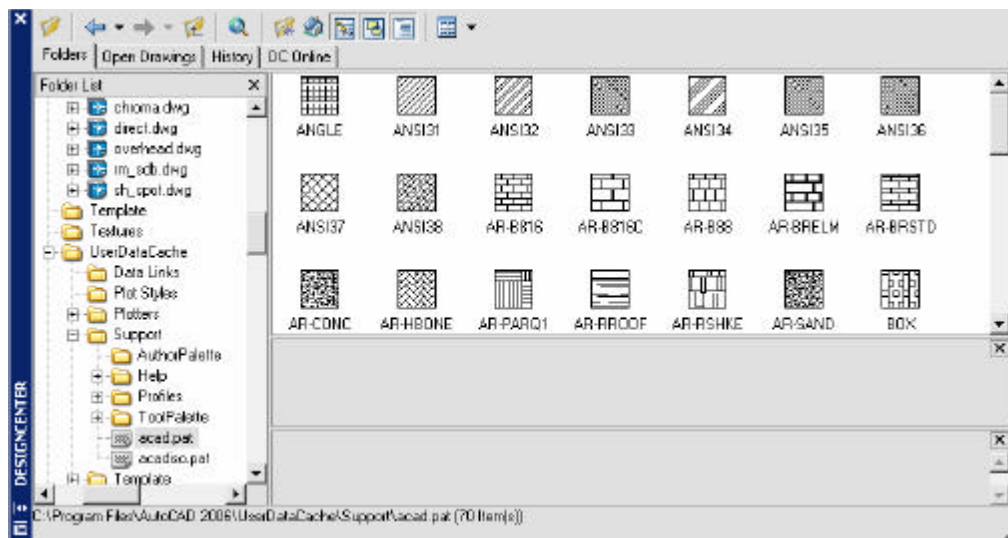

TIP:

- Be sure the HPSCALE is set before dropping a hatch pattern into a drawing.

AutoCAD 2D Tutorial

20.4 Tool Palettes

1. **Choose** Tool, ToolPalettes Window

2. **Choose** Palettes icon from the Standard Toolbar

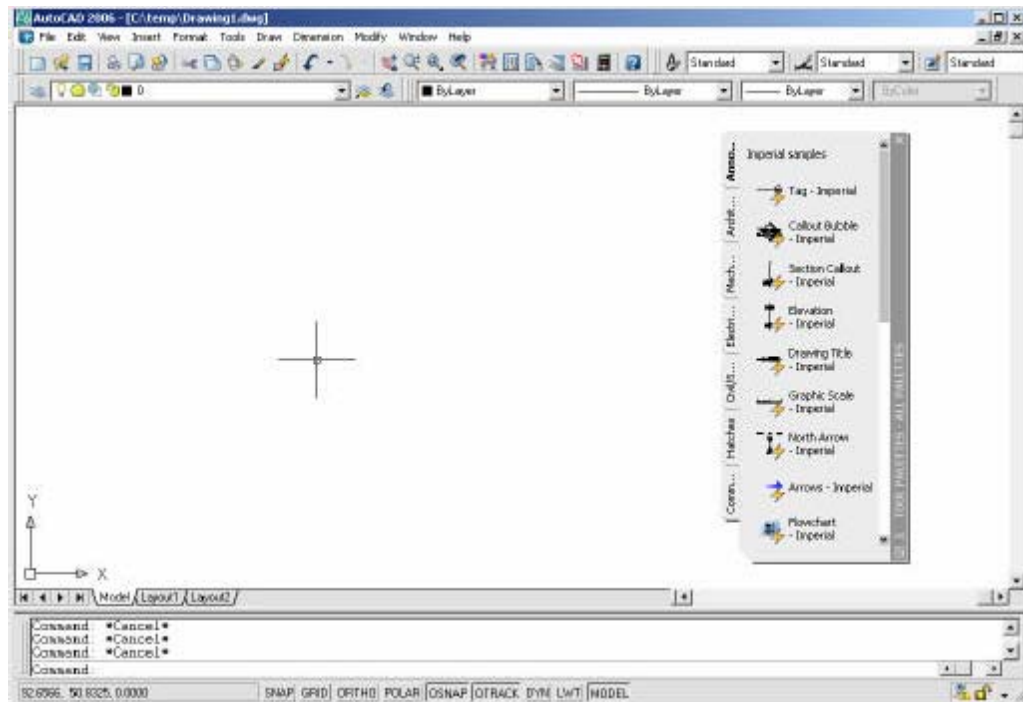

Chapter 21

Point, Divide, Measure

AutoCAD 2D Tutorial

Point Styles 21.1

Changes the appearance of points and point sizes.

1. **Choose** Format, Point Style...
or
2. **Type** DDPTYPE at the command prompt.
Command : **DDPTYPE**

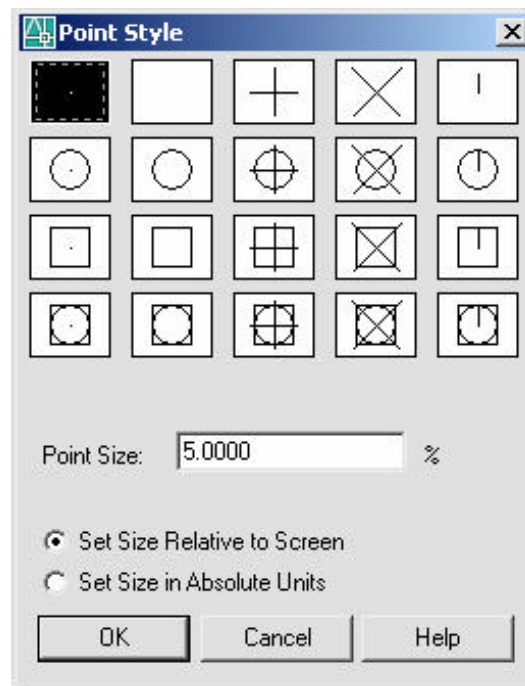

AutoCAD 2D Tutorial

Point Command 21.2

1. **Choose** Draw, Point, Single or Multiple Point.

or

2. **Click** the Point icon. 

or

3. **Type** POINT at the command prompt

Command : **POINT**

4. **Pick** A point on the drawing.

Point (**point**)

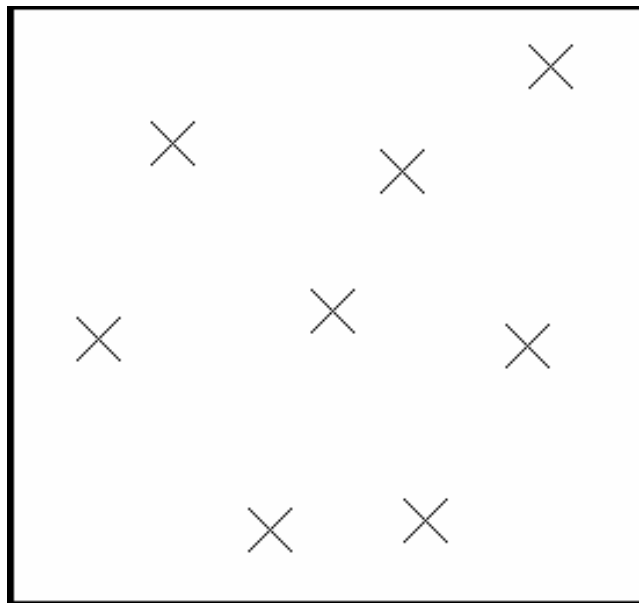

AutoCAD 2D Tutorial

Divide 21.3

1. **Choose** Draw, Point, Divide.
or
2. **Type** DIVIDE at the command prompt
Command: DIVIDE
3. **Pick** Object to divide
Select object to divide: **(pick one object)**
You can select a single Line, Arc, Circle, or
polyline. If you enter a segment count between 2
and 32,767, Point entities will be placed along
the object to divide it into that number of equal
segments.
4. **Type** The number of equal segments to divide the
object into <Number of segments>/Block:
(number)

Objects divided using points

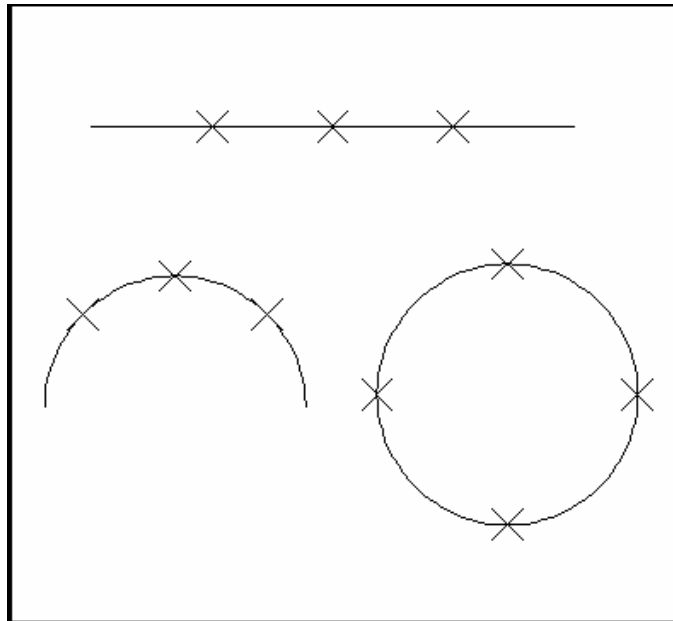

AutoCAD 2D Tutorial

or

5. **Type** B to specify a block instead of a point to insert.
6. **Type** The name of the block to insert
Block name to insert: **(name)**
7. **Type** Yes or No to align the block with an object
Align block with object? **Y** or **N** Number of segments:
8. **Type** The number of equal segments to divide the object into<Number of segments>/Block: **(number)**

TIP: The Block must currently be defined within the drawing. If you answer yes to the Align block? prompt, the Block will be rotated round its insertion point so that it is drawn tangent to the object being divided.

Objects divided using block symbols

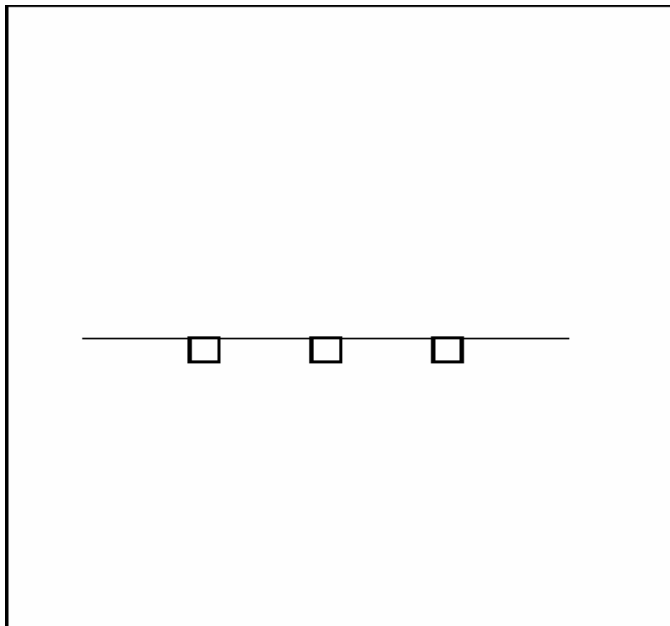

AutoCAD 2D Tutorial

Measure 21.4

1. **Choose** Draw, Point, Measure.
or
2. **Type** MEASURE at the command prompt. Command: **MEASURE**
3. **Pick** Object to measure: Select object to measure:
(pick one object)
4. **Type** The length of each segment along the object.
<Length of segment>/Block:(**number**)
or
5. **Type** B to specify a block instead of a point to insert.

*Points placed along measured distance
(remaining length is on the right side of the line)*

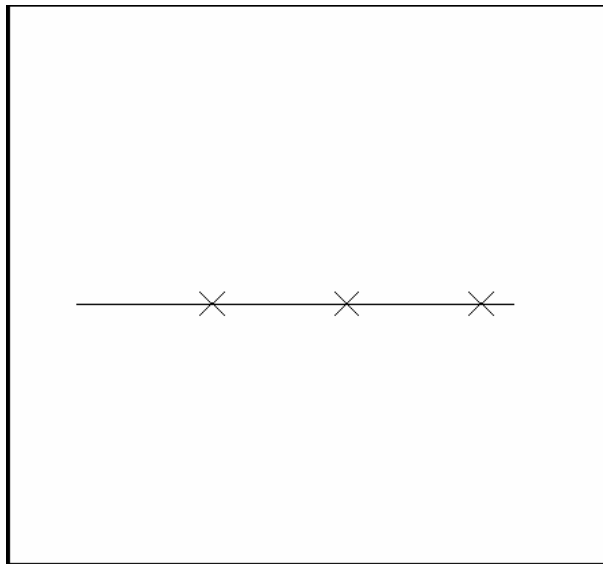

Chapter 22 Grips

AutoCAD 2D Tutorial

Grips Overview 22.1

Entity Grips

Entity grips allow AutoCAD drawings to be edited in an entirely new way. Without entering any edit commands, you can stretch, move, copy, rotate, scale, and mirror entities. You can also snap to geometric features such as endpoints, midpoints, centers, quadrants without entering object snaps.

Grips are the small squares that appear when objects are selected with the crosshairs directly from the command prompt.

Unselected Grip

An unselected grip is one that has not yet been picked with the cursor, but is an item in the current selection set (it is highlighted). Pick an object to see grips.

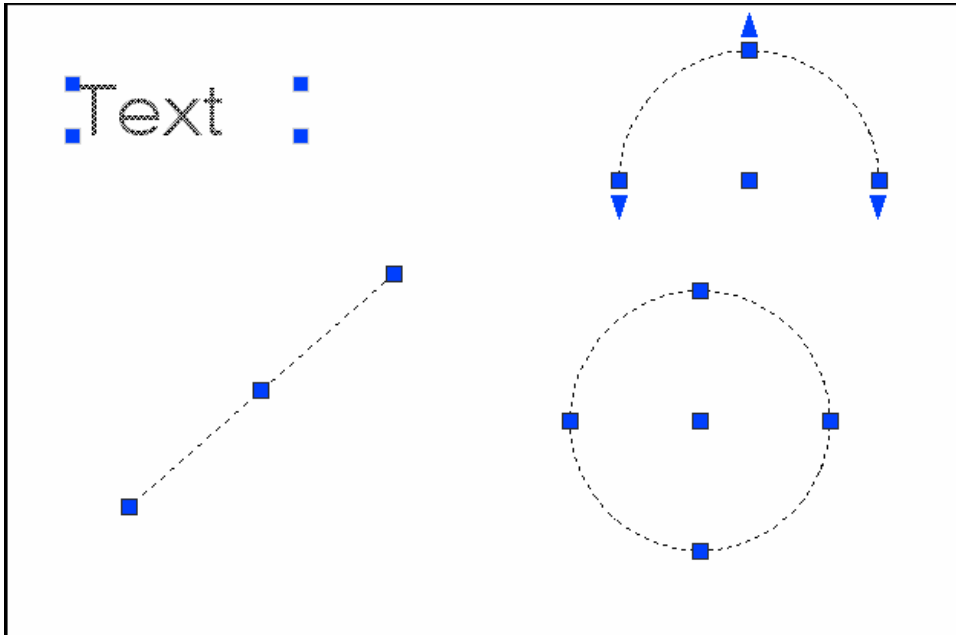

AutoCAD 2D Tutorial

Selected Grip

A selected grip is the grip box that you select with the cursor to define the base point to edit from. It has a solid filled color and is the grip location that editing is done from.

The red grip at the line endpoint is the selected grip

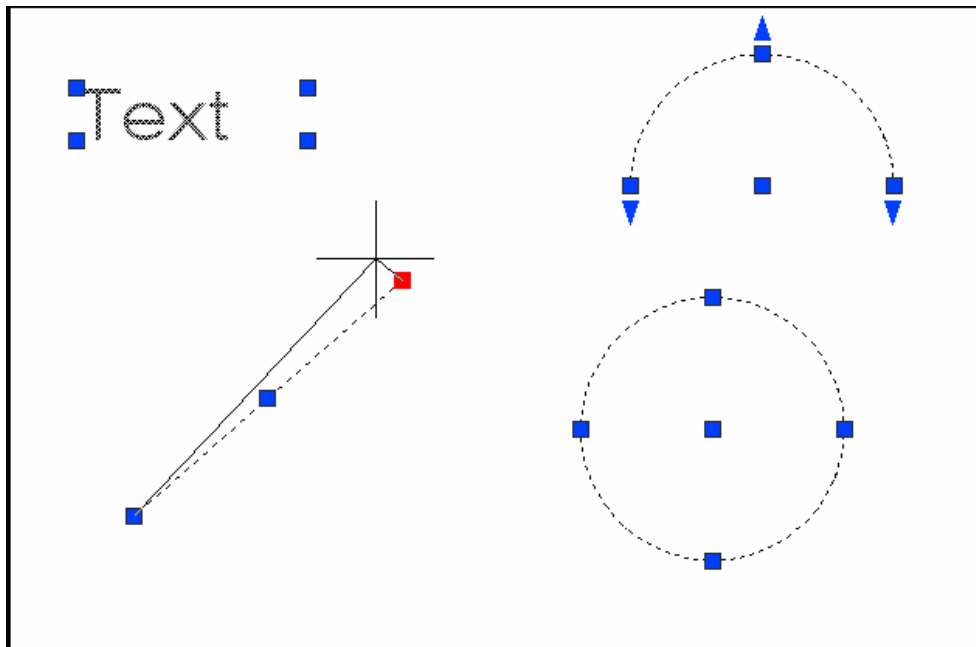

Cancelling Grips

1. **Press** **ESC** to clear GRIPS.

TIP: If grips are visible on an object, pressing the DEL key or ERASE will delete the selected object.

AutoCAD 2D Tutorial

How To Use Grips 22.2

1. **Pick** The objects you want to edit.
2. **Pick** One of the grips to use as the base grip.
3. **Press** the SPACE BAR, or RIGHT MOUSE BUTTON to cycle through the grip modes.
or
4. **Type** The keyword for the mode you want: Stretch (ST) Stretch the objects. Move (MO) Move the objects. Rotate (RO) Rotate the objects. Scale (SC) Scale the objects. Mirror (MI) Mirror the objects.
5. **Drag** The mouse to perform the operation.
6. **Type** C to create a new copy of the selection set enter C.
7. **Type** X to exit Grip mode.

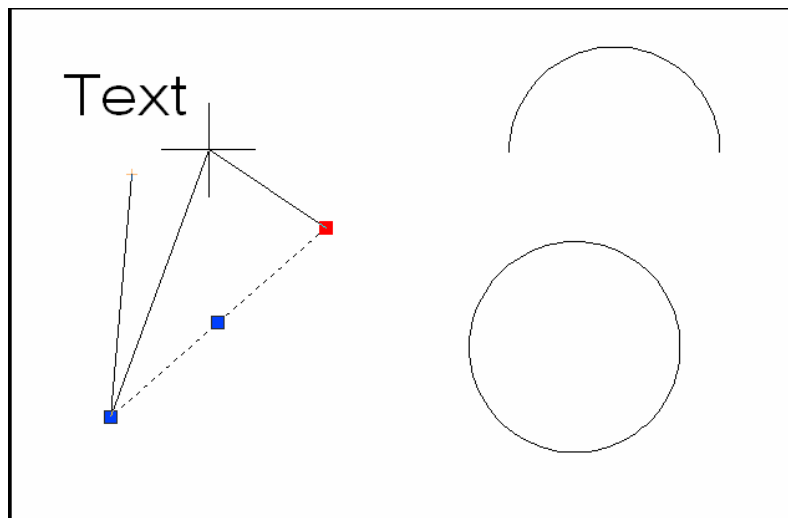

AutoCAD 2D Tutorial

Copy Multiple with Grips 22.3

If you use the COPY option with any one of the edit commands, a temporary auxiliary snap grid is created. To invoke the grid, hold the SHIFT key after specifying the location of the first copy. AutoCAD then uses the X and Y offsets from the original entity to define the snap, grid, and rotation of the remaining entities.

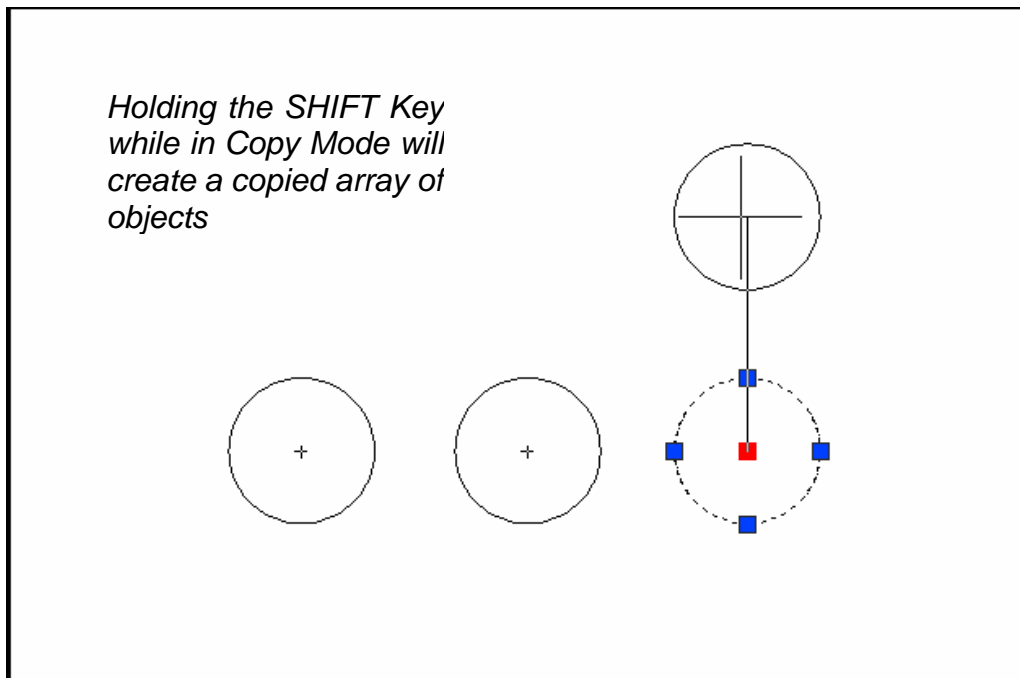

AutoCAD 2D Tutorial

Grips Settings (DDGRIPS Command) 22.4

1. **Choose** Tools,Options...
or
2. **Type** DDGRIPS at the command prompt.
Command: **DDGRIPS**
3. **Choose** the Selection tab from the dialog box.

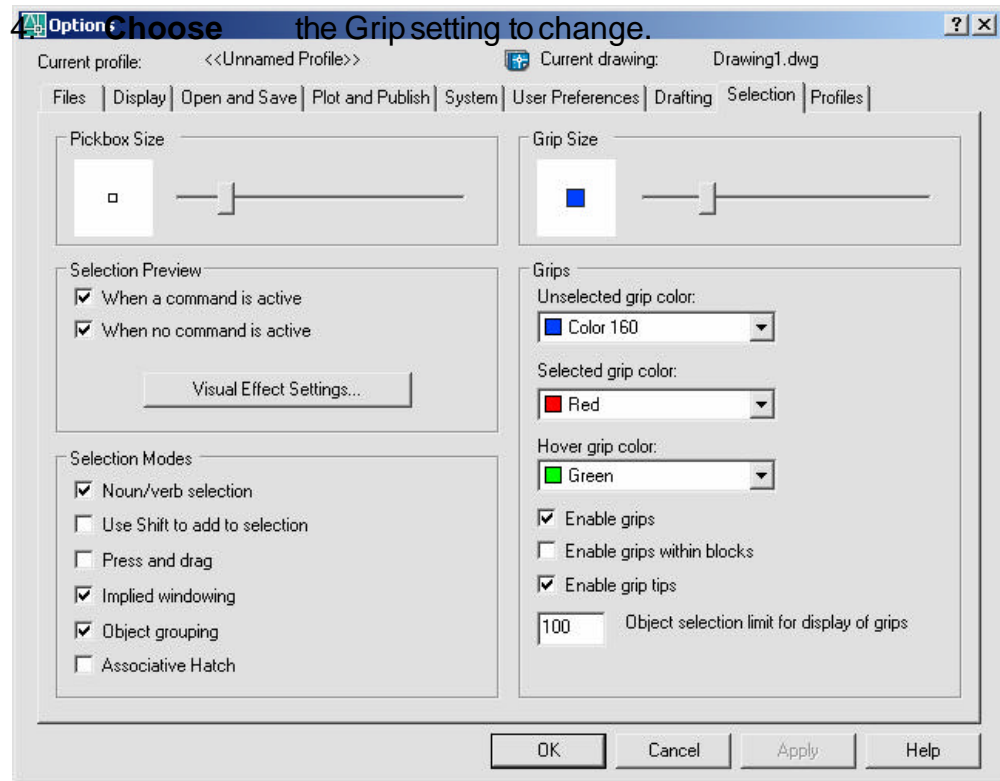

Enable Grips

Enables the display of grips. AutoCAD stores this setting in the GRIPS system variable.

AutoCAD 2D Tutorial

Enable Grips Within Blocks

Enables the display of grips on objects within blocks. If you disable this setting (but have Enable Grips selected), blocks are assigned one grip at their insertion point. Disable this setting to work on blocks with many objects. AutoCAD stores this setting in the GRIPBLOCK system variable.

Unselected

Sets the color of unselected (unfilled) grips. Choosing this button displays the Select Color dialog box, in which you set the grip color. AutoCAD stores the color in the GRIPCOLOR system variable.

Selected

Sets the color of selected (filled) grips. Choosing this button displays the Select Color dialog, in which you set the grip color. AutoCAD stores the color in the GRIPHOT system variable.

Grip Size

Changes the size of grips. To adjust the size of grips, move the slider box left or right. AutoCAD stores the pixel size (1-255) of the grips in the GRIPSIZE system variable. Changes the size of grips. To adjust the size of grips, move the slider box left or right. AutoCAD stores the pixel size (1-255) of the grips in the GRIPSIZE system variable.

Chapter 23 **Advanced Selection** **Commands**

AutoCAD 2D Tutorial

Selection Modes 23.1

1. **Choose** Tools, Options...
2. **Choose** the Selection TAB from the following dialog.

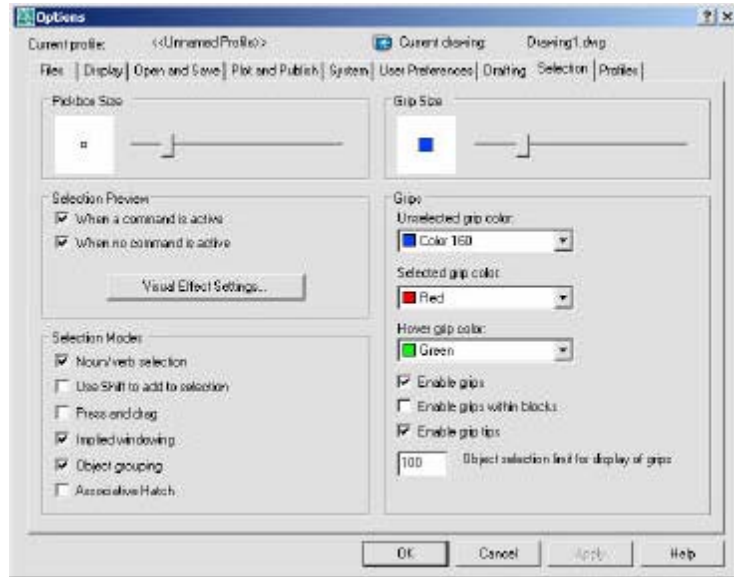

3. **Change** the settings as desired.

Noun/Verb Selection

Allows you to select an object before starting a command. The command affects the previously selected object or objects. You can also set this option by using the PICKFIRST system variable.

Use Shift to Add to Selection

Adds or removes an object to the selection set when you press SHIFT and select an object.

Press and Drag

Draws a selection window by selecting a point and dragging the pointing device to a second point.

AutoCAD 2D Tutorial

Implied Windowing

Initiates the drawing of a selection window when you select a point outside an object.

Object Grouping

Selects all objects in a group when you select one object in that group. With GROUP you can create and name a set of objects for selection.

Associative Hatch

Determines which objects are selected when you select an associative hatch. If this option is selected, boundary objects are also selected when you select an associative hatch.

AutoCAD 2D Tutorial

Groups 23.2

1. **Type** GROUP at the command prompt.
Command:**GROUP**
2. **Type** a name for a new group.
3. **Choose** the Newbutton under Create Group.
4. **Pick** objects to be included in the group.
5. **Press** ENTER whendone choosing objects.
6. **Pick** OK.

Lines in a group

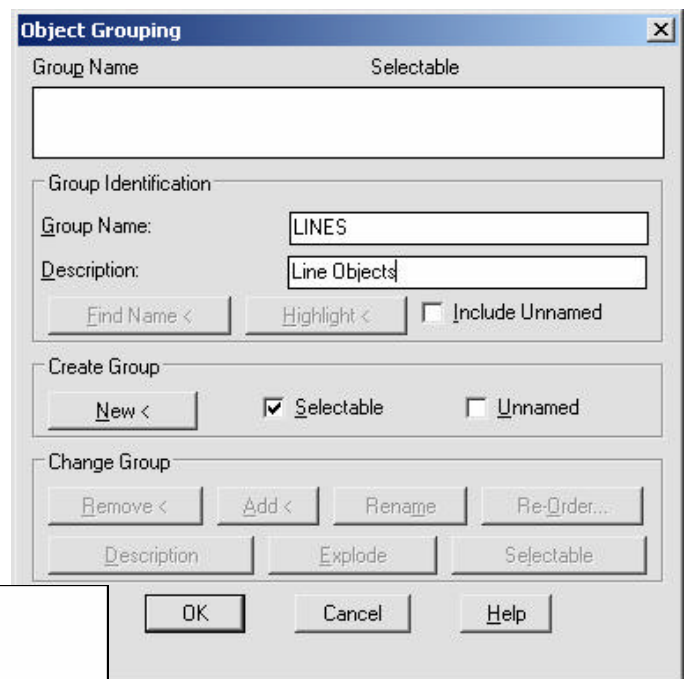
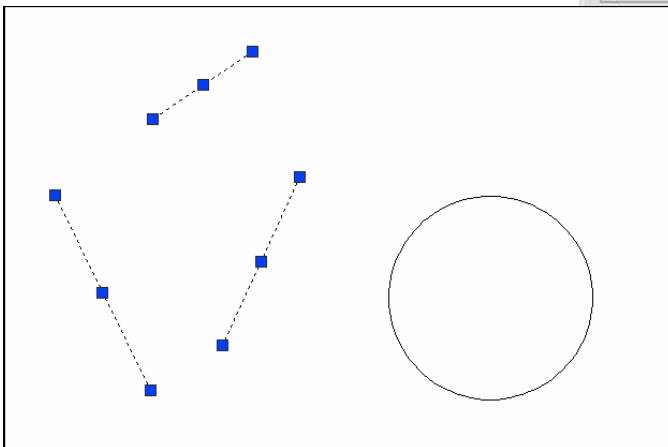

Turning Groups ON/OFF

At any time, toggle group selection on and off by pressing either CTRL+H or SHIF T+CTRL+A.

AutoCAD 2D Tutorial

Object Selection Cycling 23.3

It is difficult to select objects that are close together or lie directly on top of one another. The following example shows two lines and a circle that all lie within the selection pickbox

1. **Press** the CTRL key before choosing objects at the Select Objects prompt.
2. **Pick** repeatedly in the area where multiple objects are located. AutoCAD will cycle through all objects that were touching the pickbox.
3. **Press** ENTER when the desired object highlights.
4. **Press** ENTER again.

Objects touching pickbox

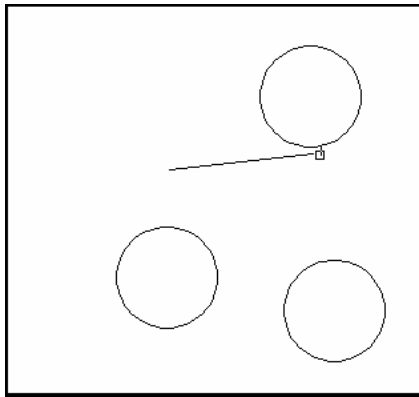

First object selected highlights

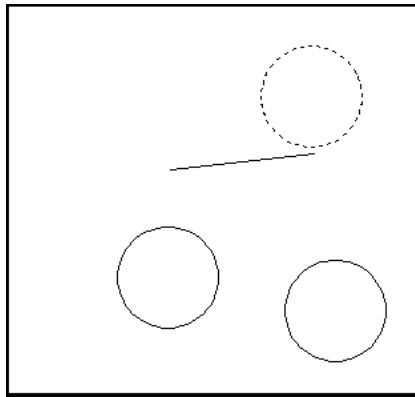

Second object selected

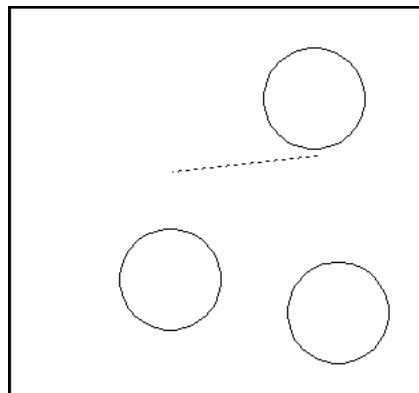

AutoCAD 2D Tutorial

Double-Click Edit 23.4

1. **Double-Click** an object to edit.

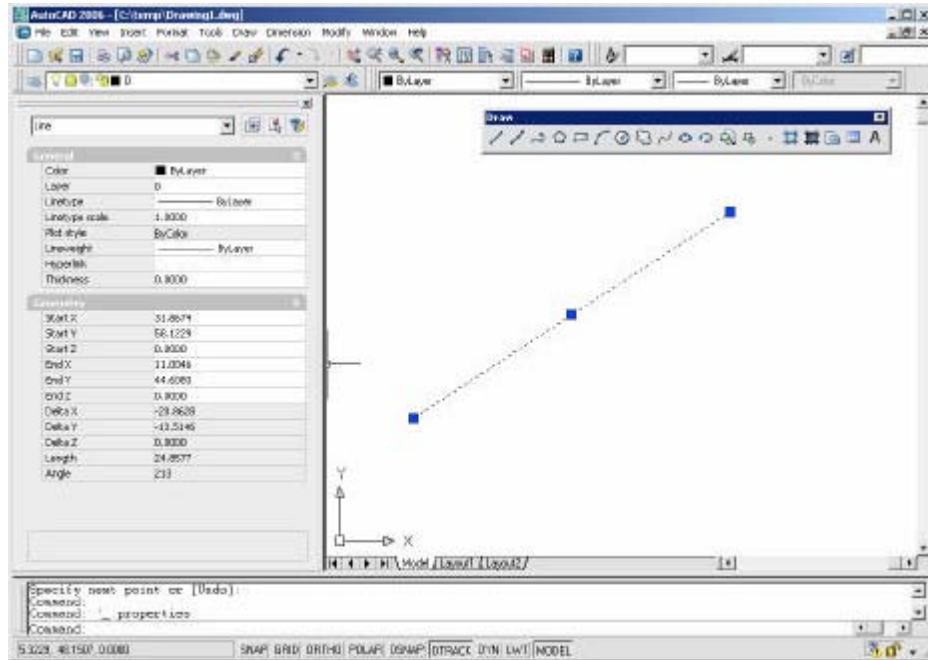

AutoCAD 2D Tutorial

Draw Order 23.5

1. Choose Tools, DisplayOrder.
or
2. Click the Draworder Icon from the Modify II Toolbar.
or
3. Type DRAWORDER at the command prompt.
Command: **DRAWORDER**
Select objects: pick an object.

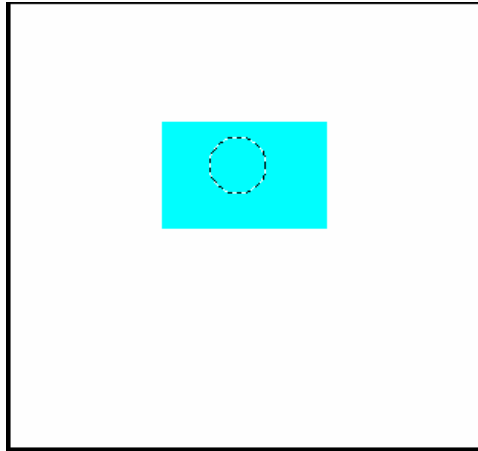

AutoCAD 2D Tutorial

Object Filters 23.6

1. **Type** FILTER at the Command prompt.
2. **Select** Line in the Object Selection Filters dialog box under Select Filter.
3. **Choose** Add to List.
4. **Choose** Apply.
5. **Type** ALL at the Select Objects prompt or select a window.

Command:

FILTER Applying filter to selection.

Select objects: **all**

6 found

3 were filtered out.

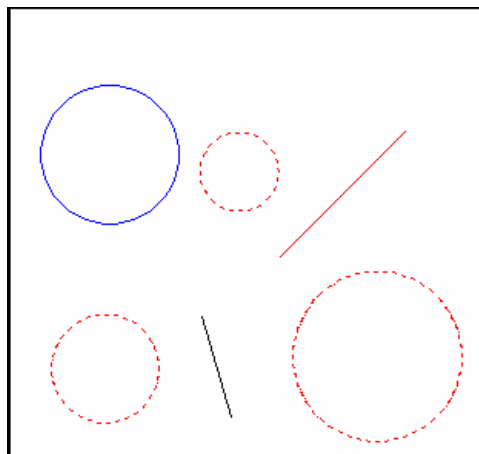
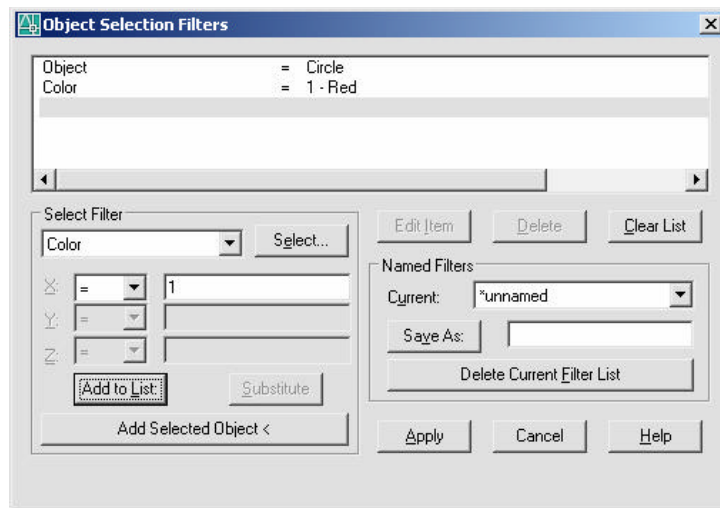

AutoCAD 2D Tutorial

Quick Select 23.7

1. **Type** QSELECT at the command prompt.
Command: **QSELECT**
2. **Enter** the selection criteria (i.e. TEXT HEIGHT < .5)
3. **Choose** OK.

TIP: AutoCAD puts those object(s) into a selection set. Use the “P” previous option to select these objects.

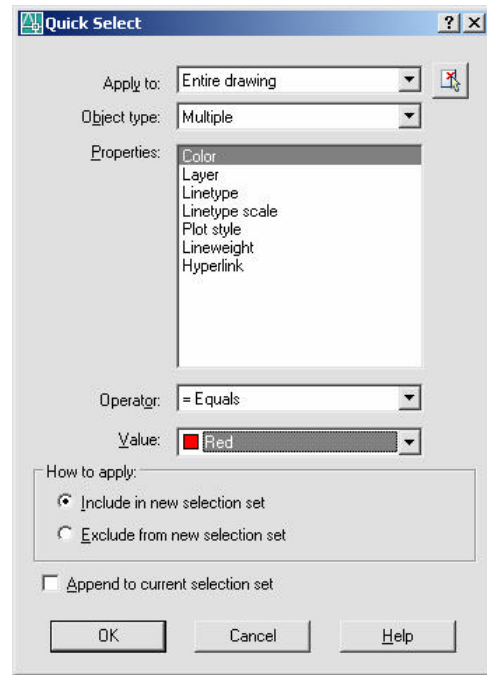
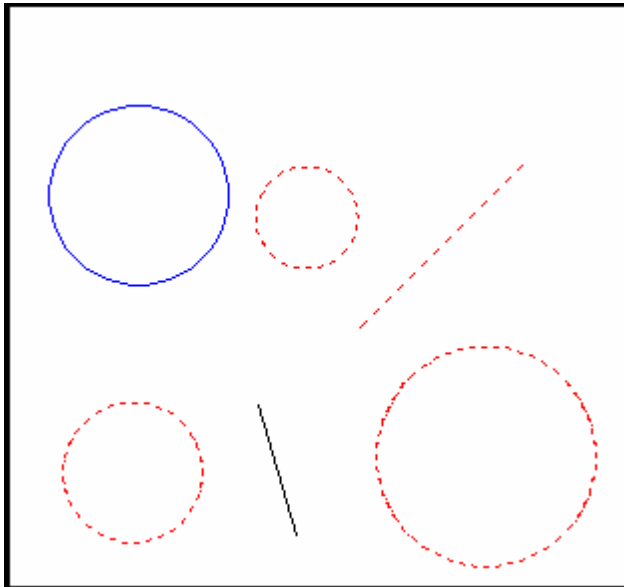

AutoCAD 2D Tutorial

Layer Filters 23.8

1. **Choose** the layer dialog box.
2. **Choose** the three dots (...) to invoke the filter dialog for layers.

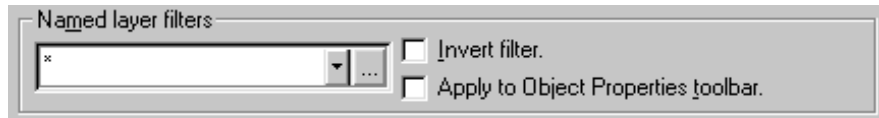

3. **Choose** the type of filter you would like to use (e.g. layer name = 1st*)

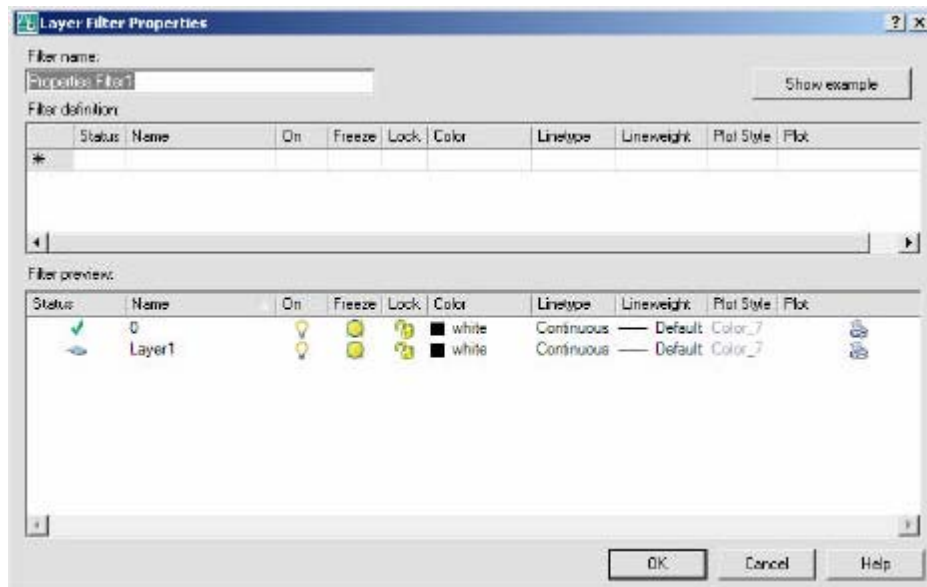

AutoCAD 2D Tutorial

Point Filters 23.9

AutoCAD point filters allow the user to specify one coordinate, such as the X, with one pick and a second coordinate, such as the Y, with another pick. The point filters are .X, .Y, .XY, .XZ and .YZ. Only .X and .Y are used for two dimensional drawings.

1. **Type** A command that asks for a point.
Command:**CIRCLE**
2. **Type** .X when AutoCAD asks for a point.
3P/2P/TTR/<center point>: **.X**
3. **Pick** The point to filter (HINT: use osnaps)
of **MID of point on x axis**
4. **Pick** The next point to filter
(needYZ)
MID of point on y axis
5. **Pick** A diameter or radius
Diameter/<radius>: Pick or type a diameter

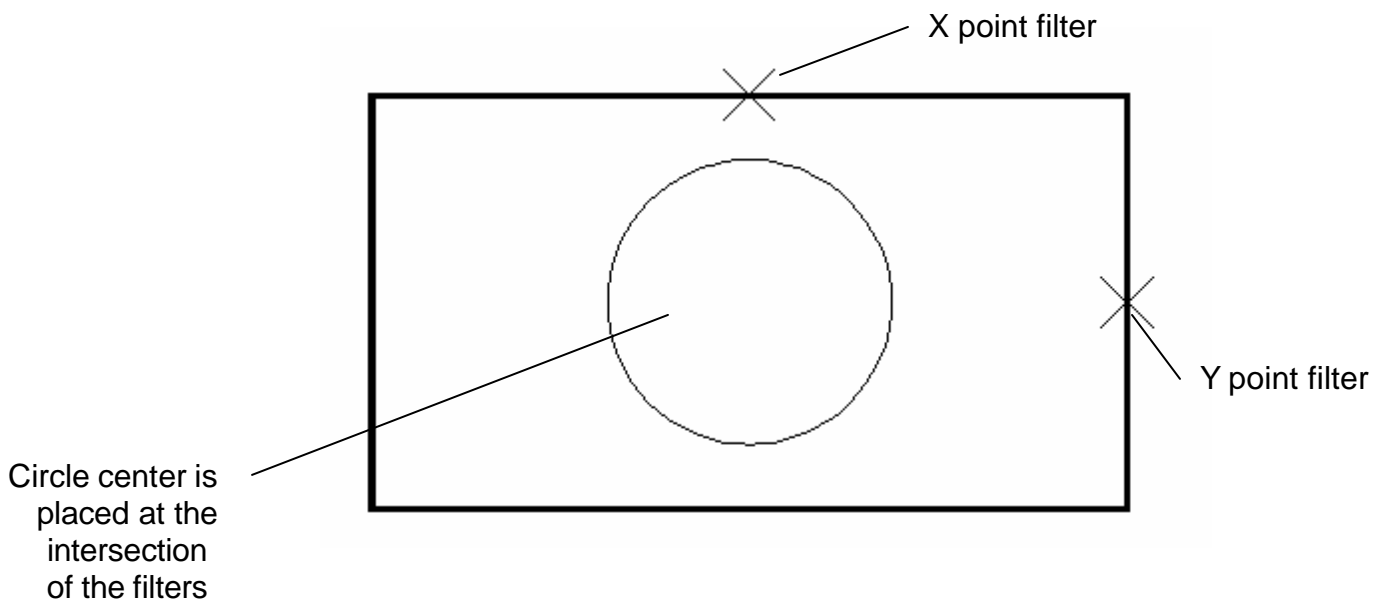

Chapter 24 External References

AutoCAD 2D Tutorial

External Reference Files Overview

Attaches, overlays, lists, binds, detaches, reloads, unloads, renames, and modifies paths to external references (xrefs) in the current (or host) drawing.

1. **Choose** Insert, ExternalReference...
or
2. **Click** the Xref Icon from the Reference Toolbar. 
or
3. **Type** XREF at the command Prompt.
Command: **XREF**

The following are Xref characteristics:

- An external reference file is known as an “Xref”.
- Current drawing contains only a “pointer”, the path and filename, to the Xref.
- The current drawing does not increase much in size when it contains an Xref.
- The Xref is reloaded each time the current drawing is loaded, thus always showing the latest revision of the Xref.
- Xrefs import their linetypes, layers, text styles, dimstyles, views, ucs’s, vports, and blocks into their current drawing.
- Each Xref named object is prefixed with the xref drawing name and a pipe “|” symbol.
(i.e. HOUSE|A-WALL for drawing house.dwg and layer a-wall)
- Xdep stands for external reference dependent objects.
- Xref’s layers can be turned on/off in the current drawing.
- Layer zero(0) resides on layer zero(0) of the current drawing.
- Xrefs can be bound to the current drawing, in which case they become blocks.

AutoCAD 2D Tutorial

- Xref layers cannot be made current the the drawing they are xreferenced into.
- Xrefs can be snapped to.
- Xref entities cannot be individually modified in the current drawing.
- Xrefs can be plotted.
- Xrefs can be detached from the current drawing and will disappear.
- The current drawing pointer, file and pathname can be changed.
- Xrefs can be re-loaded during the current drawing session.
- Xrefs can be nested.
- Xrefs can be clipped to show parts of the reference files.

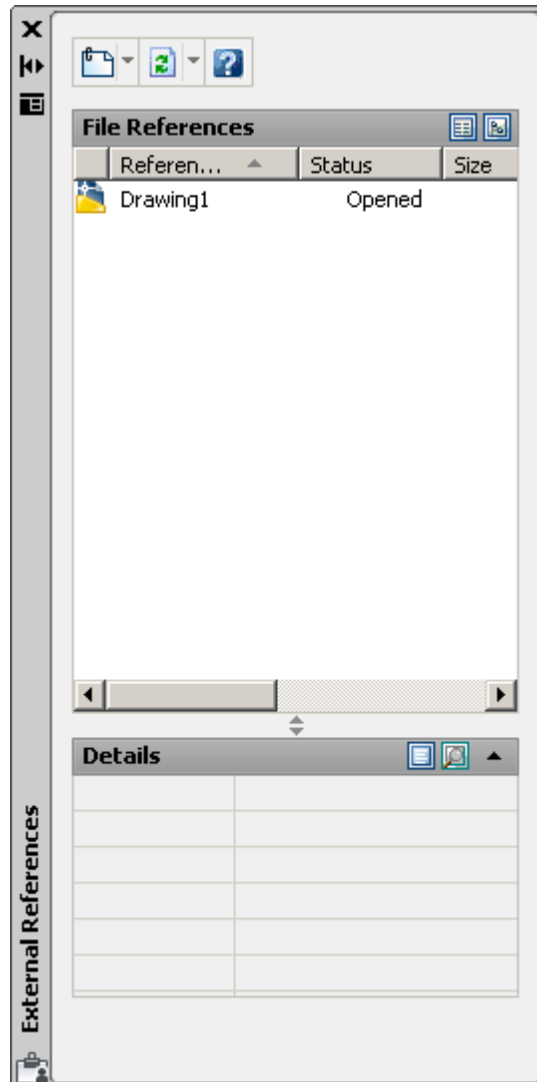

AutoCAD 2D Tutorial

Attaching Xrefs 24.1

Attaches, overlays, lists, binds, detaches, reloads, unloads, renames, and modifies paths to external references (xrefs) in the current (or host) drawing.

1. **Choose** Insert, ExternalReference
or
2. **Type** XATTACH at the command prompt.
or
3. **Click** the XrefAttachIcon from the Reference Toolbar. 
4. **Choose** a drawing name to attach.

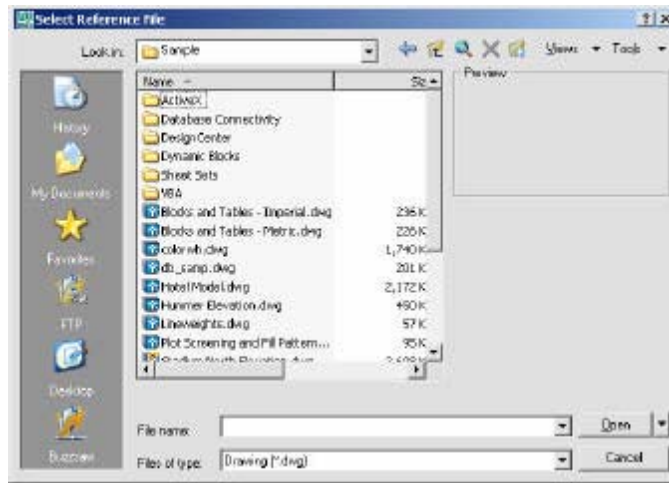

5. **Specify** the insertion parameters.

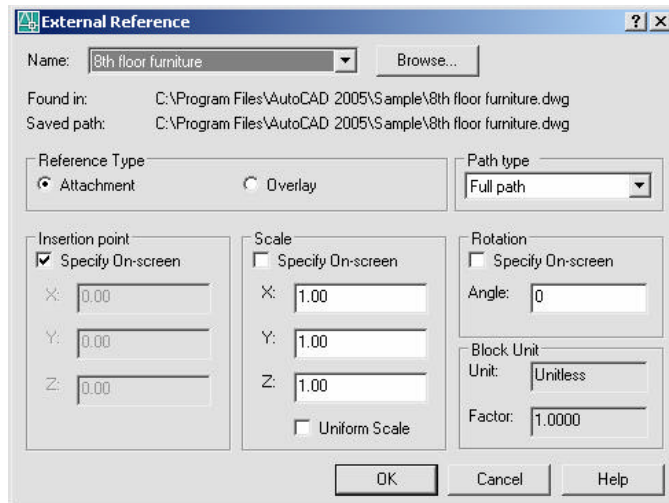

AutoCAD 2D Tutorial

Xref Layers 24.2

Layer Dialog Box

- Each Xref named object is prefixed with the xref drawing name and a pipe “|” symbol. (i.e. HOUSE|A-WALL for drawing house.dwg and layer a-wall)
- Xdep stands for external reference dependent objects.
- Xref’s layers can be turned on/off in the current drawing.
- Layer zero(0) resides on layer zero(0) of the current drawing.
- Xref layers cannot be made current the the drawing they are xreferenced into.

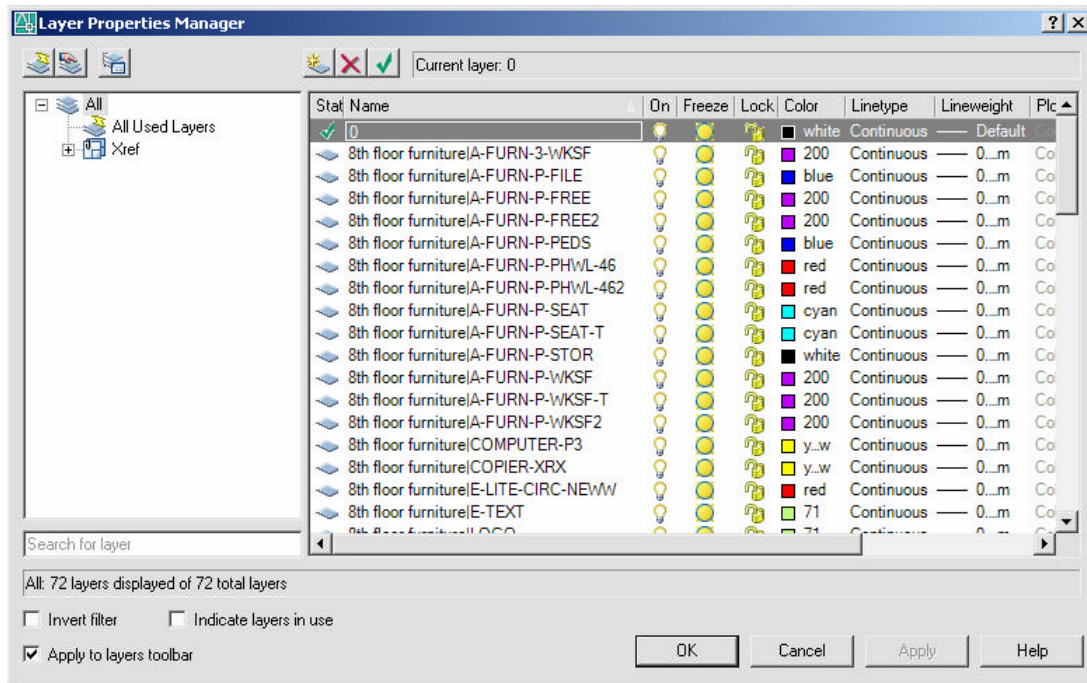

AutoCAD 2D Tutorial

Xclip 24.3

Defines an xref or block clipping boundary and sets the front or back clipping planes.

1. **Choose** Modify, Clip, XRef
or
2. **Click** the Xclip Icon from the Reference Toolbar. 
or
3. **Type** XCLIP at the command prompt.
Command: **XCLIP** Select objects:
Other corner: 1 found Select objects:
pick reference file
ON/OFF/Clipdepth/Delete/generate Polyline/
<New boundary>:
Specify clipping boundary:
Select polyline/Polygonal/<Rectangular>: First corner:
Other corner: **pick corners**

Defining a Clipping Boundary

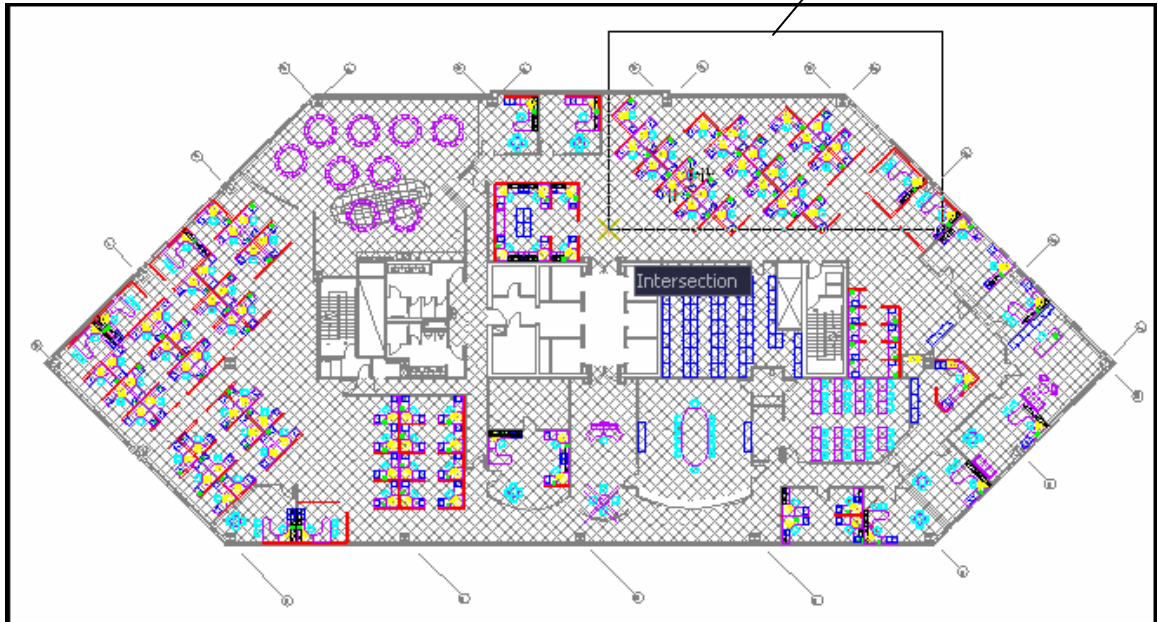

AutoCAD 2D Tutorial

Xclipframe 24.4

Controls visibility of xref clipping boundaries.

1. **Choose** Modify, Object, ExternalReference.
or
2. **Type** XCLIPFRAME at the command prompt.
Command: **XCLIPFRAME**

0 Clipping boundary is not visible

1 Clipping boundary is visible

Turning xclip frame on/off

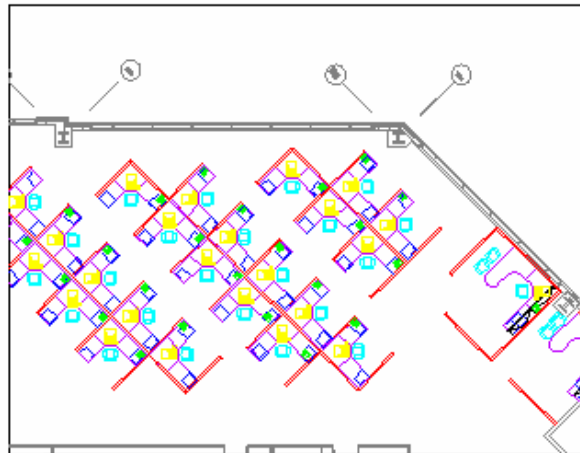

AutoCAD 2D Tutorial

Binding an Xref 24.5

Converts Xreference files to block definitions in the current drawing. Associated objects change names (i.e. the layer called HOUSE|A-WALL becomes HOUSE\$0\$A-WALL). Binding loses the connection to the referenced file. Xrefs can also be inserted like Wblocks.

To Bind an Xref:

1. **Choose** Insert, Xref Manager
2. **Choose** an xref name.
3. **Choose** the Bind option.

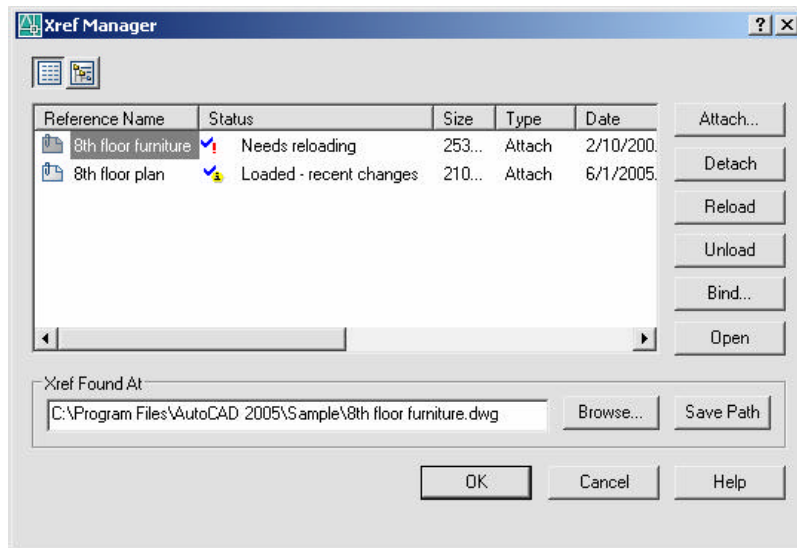

4. **Choose** Bind or Insert.
5. **Choose** OK.

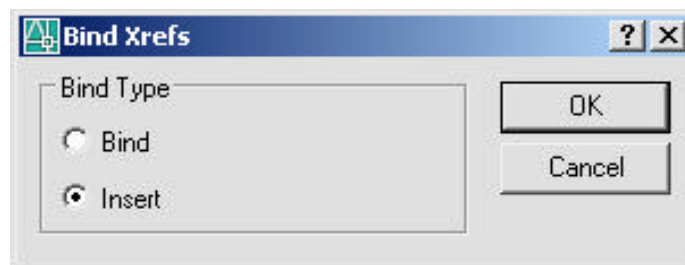

AutoCAD 2D Tutorial

Xbind 24.6

The XBIND command is used to bind layers, blocks, linetypes, styles, and dimstyles of an attached xref without binding the entire xref.

1. **Choose** Modify, Object, External
Reference, Bind...

or

2. **Click** the Xbind Icon from the Reference Toolbar. 

3. **Type** XBIND at the command prompt.

Command: **XBIND**

Block / Dimstyle / LAYER / LType / Style:

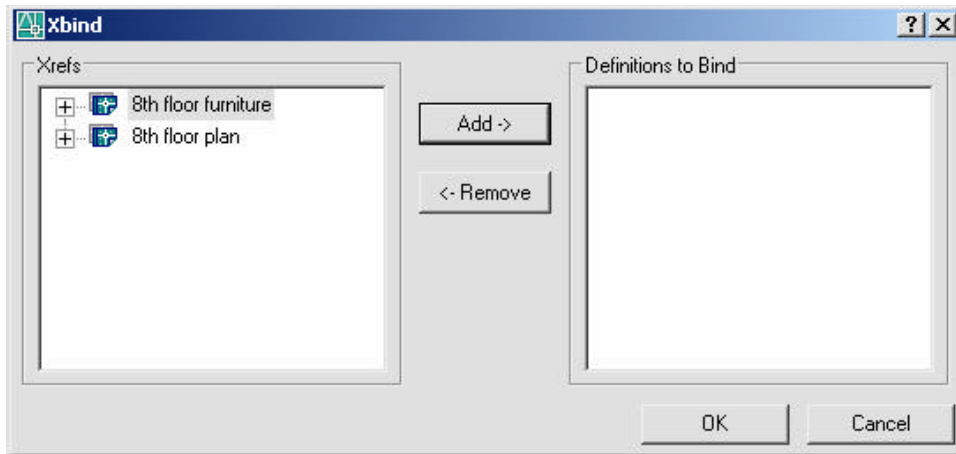

AutoCAD 2D Tutorial

Editing Xrefs (Xref Manager) 24.7

Detaching Xrefs

Detaches one or more xrefs from your drawing, erasing all instances of a specified xref and marking the xref definition for deletion from the symbol table.

1. **Choose** a drawing name to detach from the Xref Dialog.
2. **Choose** the Detach option.

Unload an Xref

Unloads one or more xrefs. Unloaded xrefs can be easily reloaded. Unlike detach, unloading does not remove the xref permanently. It merely suppresses the display and regeneration of the xref definition, to help current session editing and improvement of performance.

1. **Choose** a drawing name to unload from the Xref Dialog.
2. **Choose** the Unload option.

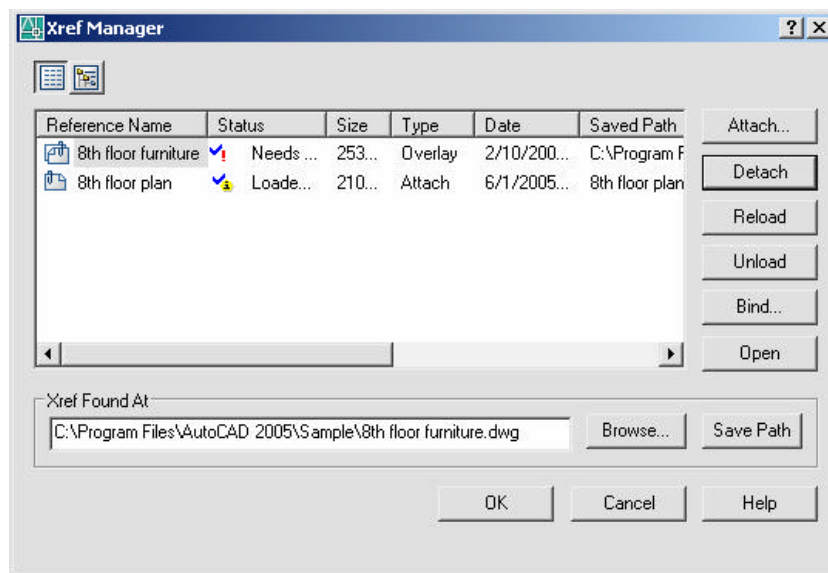

AutoCAD 2D Tutorial

Reload an Xref

Marks one or more xrefs for reloading. This option re-reads and displays the most recently saved version of the drawing.

1. **Choose** a drawing name to reload from the Xref dialog.
2. **Choose** the Reload option.

Opening Xrefs to Edit

1. **Choose** Modify, Xref and Block Editing, Open Reference.
or
2. **Choose** Modify, Xref and Block Editing, Edit Xreference in Place.
3. **Edit** the objects as desired.
4. **Save** the edits with the following icons.

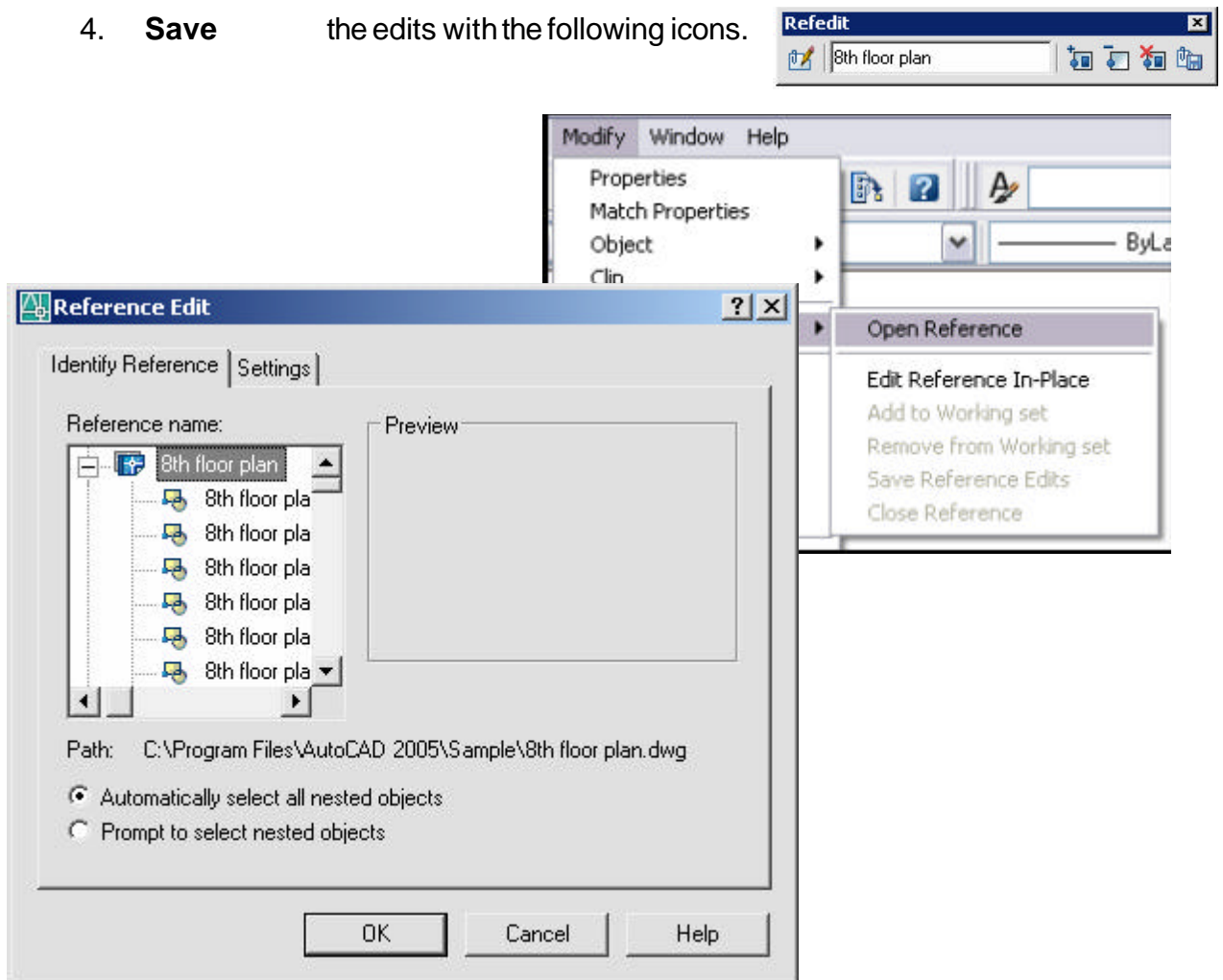

AutoCAD 2D Tutorial

Overlay an Xref 24.8

Overlays are typically used when you need to view another drawing's geometry temporarily, but don't plan to plot using that data. In the following illustration, several people are working on drawings referenced by master.dwg. The person working on a.dwg needs to see the work being completed by the person working on b.dwg, but does not want to xref b.dwg because it would then appear twice in master.dwg. Instead, the person overlays b.dwg, which is not included when a.dwg is referenced by master.dwg.

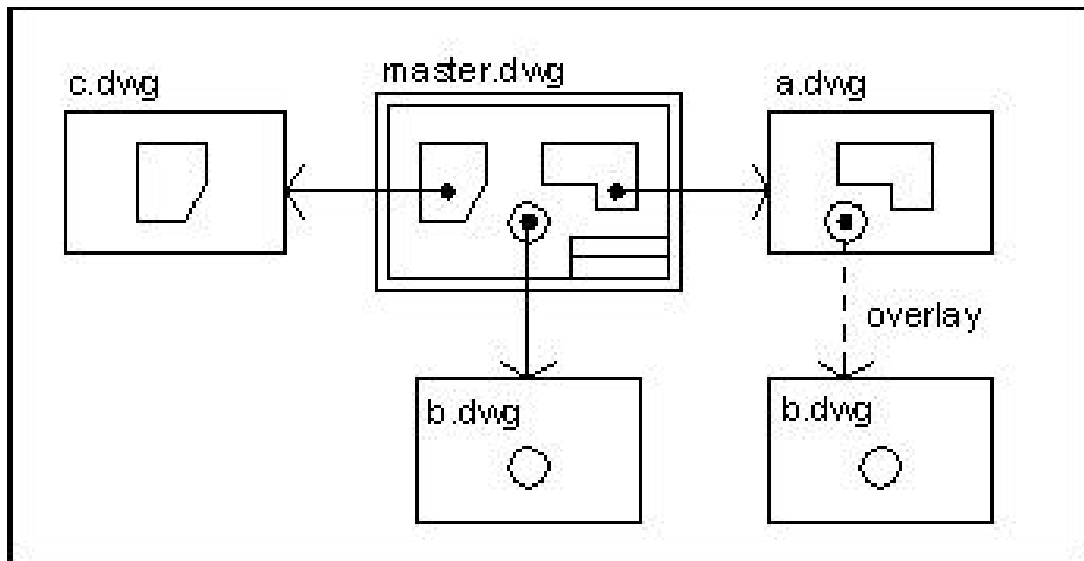

1. **Choose** the Attach option from the Xref Dialog.
or
2. **Click** the Xref Attach Icon from the Reference Toolbar.
3. **Choose** a drawing name to attach.
4. **Choose** Overlay in the Attach Xref dialog box under Reference Type.

AutoCAD 2D Tutorial

5. **Specify** the insertion parameters.

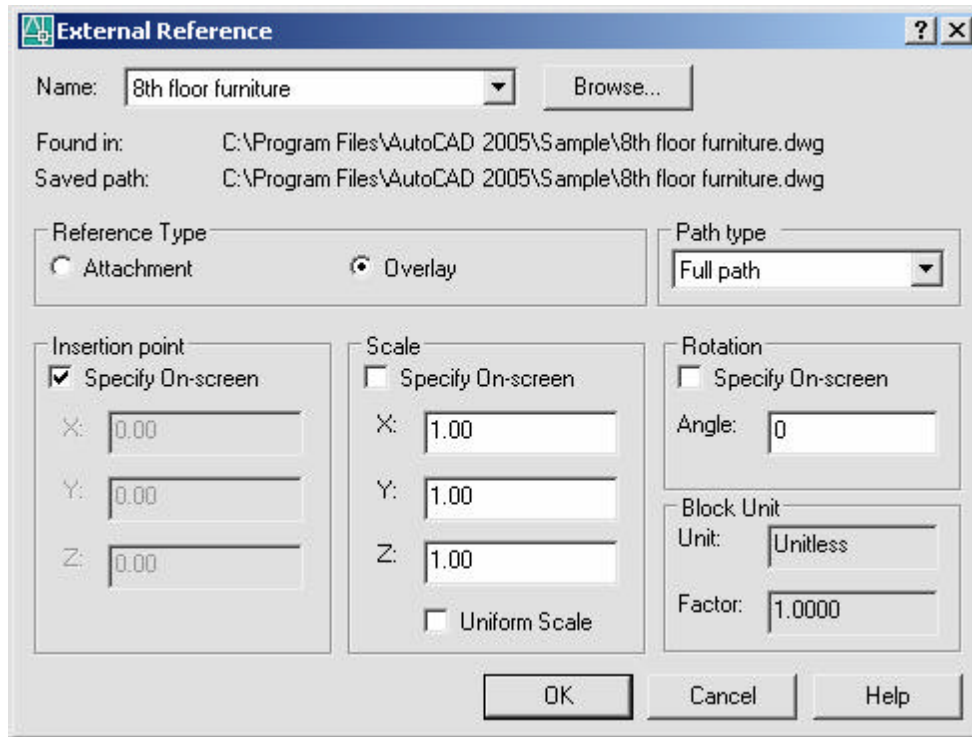

Chapter 25 Raster Images

AutoCAD 2D Tutorial

Inserting Images 25.1

1. **Choose** Insert, Raster Image...
2. **Choose** a raster image file to insert.
3. **Specify** a location to insert the image.
or
4. **Type** IMAGEATTACH at the command prompt.
Command: **IMAGEATTACH**
or
5. **Click** the Image icon from the Reference Toolbar. 

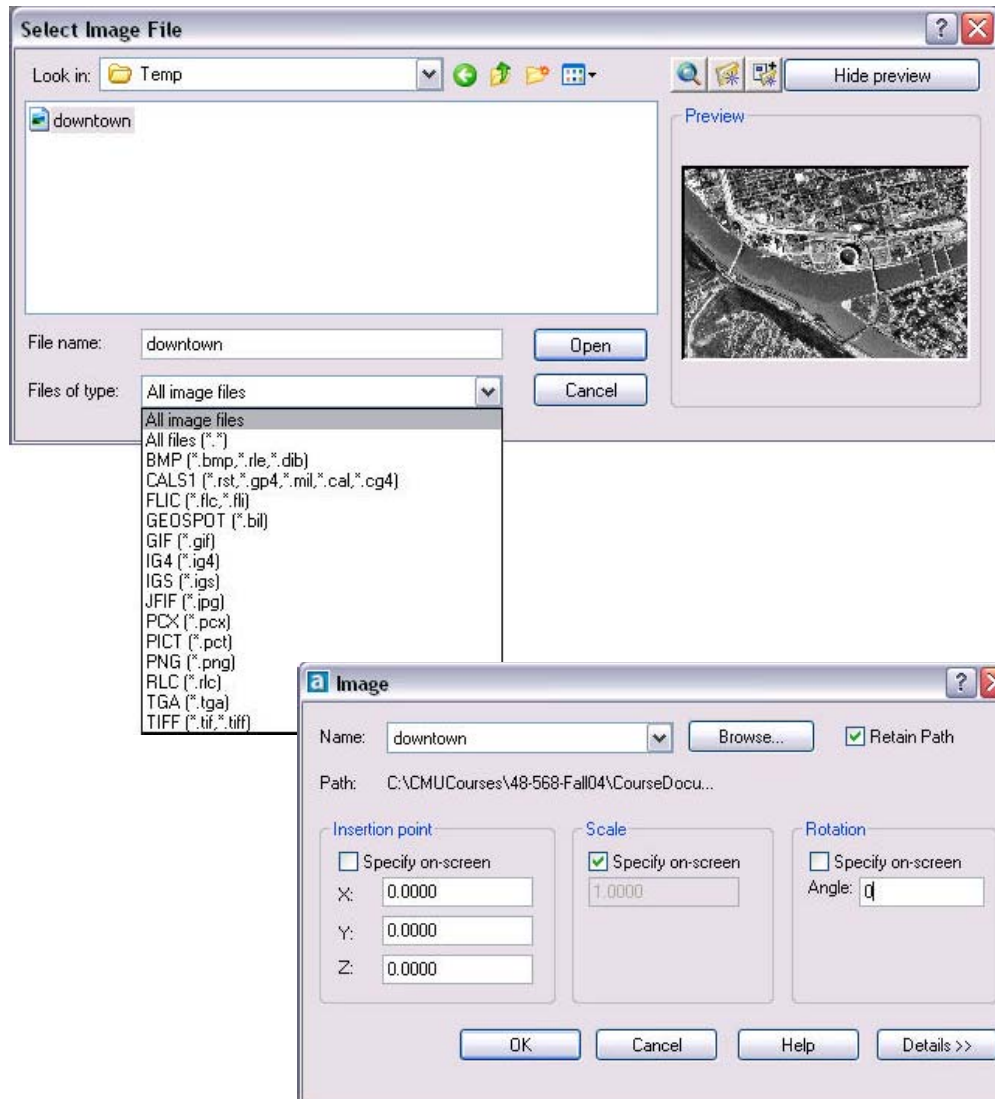

AutoCAD 2D Tutorial

Image Appearance 25.2

Adjusting Image Appearance

1. **Choose** Modify, Object, Image, Adjust...
2. **Choose** a raster image file edit.
3. **Choose** options from the dialog box to adjust.

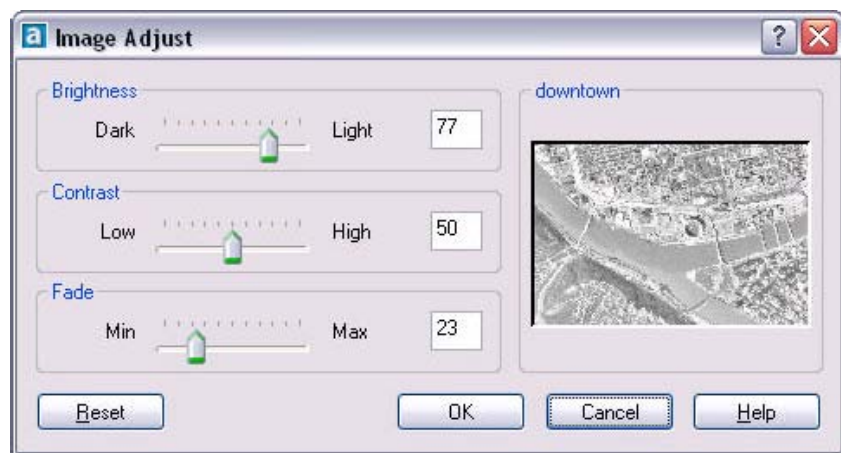

AutoCAD 2D Tutorial

Image Transparency

1. **Choose** Modify, Object, Image, Transparency.
2. **Choose** a raster image file edit.
3. **Type** ON or OFF to turn an image's transparency on or off.

Erasing Images

1. **Click** once on the image to remove.
2. **Choose** Edit, Cut.

Imagequality

1. **Type** IMAGEQUALITY at the command prompt.
Command: **imagequality**
Enter image quality setting [High/Draft] <High>:

AutoCAD 2D Tutorial

Clipping Images 25.3

1. **Choose** Modify, Clip, Image.



Chapter 26
Dimensioning

AutoCAD 2D Tutorial

Linear Dimensions 26.1

1. **Choose** Dimension, Linear.
or
2. **Click** the Linear Dimension command from the toolbar.



3. **Type** DIM at the command prompt.
or
DIM at the command prompt.
Command: **DIM**
Dim: HOR or VER

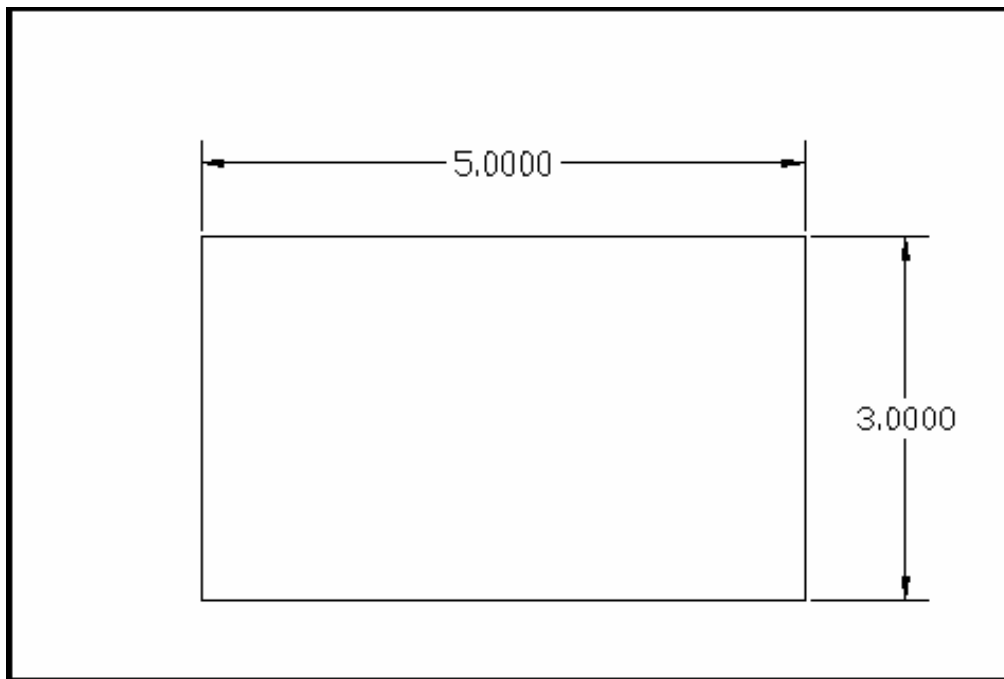

AutoCAD 2D Tutorial

Aligned Dimensions 26.2

1. **Choose** Dimension, Aligned.
or
2. **Click** the Aligned Dimension command from the toolbar.

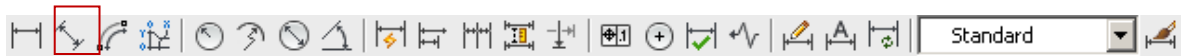

3. **Type** DIM at the command prompt.
or
DIM at the command prompt.
Command: **DIM**
Dim: **ALIGNED**

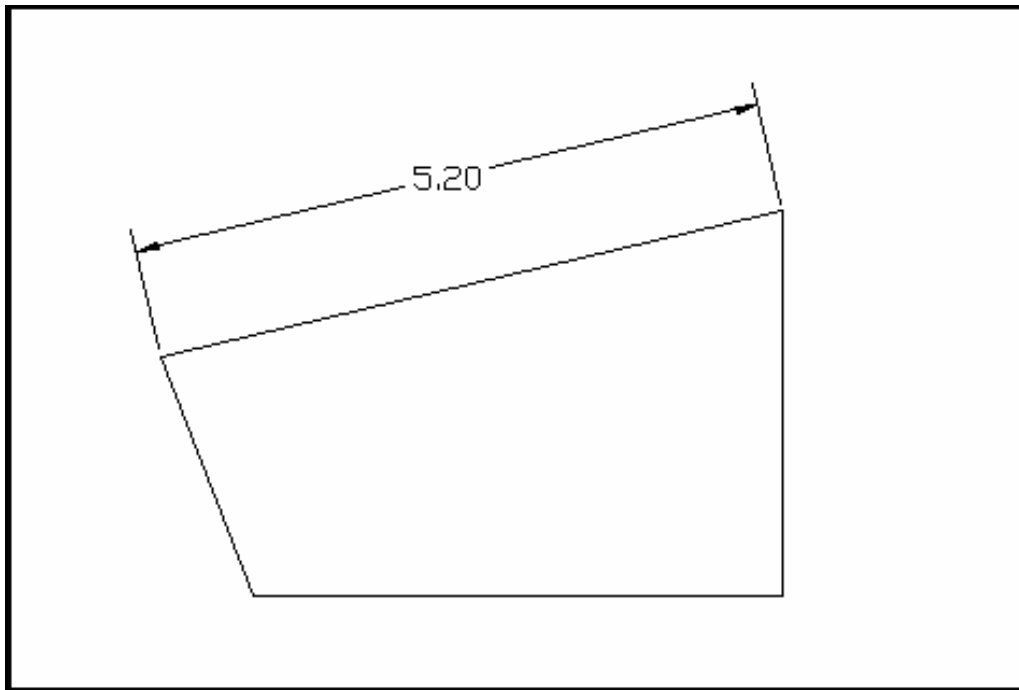

AutoCAD 2D Tutorial

Radial Dimensions 26.3

1. **Choose** Dimension, Radius or Diameter.
or
2. **Click** the Radial Dimensions command from the toolbar.



3. **Type** DIM at the command prompt.
or
DIM at the command prompt.
Command: **DIM**
Dim: **RADIUS or DIAMETER**

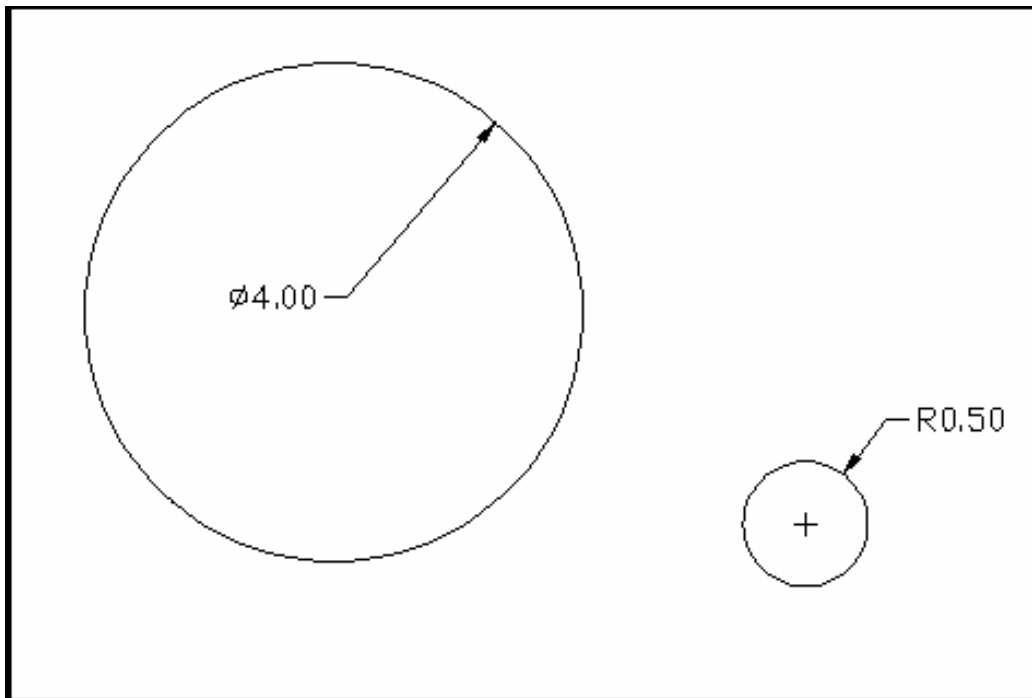

AutoCAD 2D Tutorial

Angular Dimensions 26.4

1. **Choose** Dimension, Angular.
- or
2. **Click** the Angular Dimensions command from the toolbar.



- or
3. **Type** DIM at the command prompt.
Command: **DIM**
Dim: **ANGULAR**

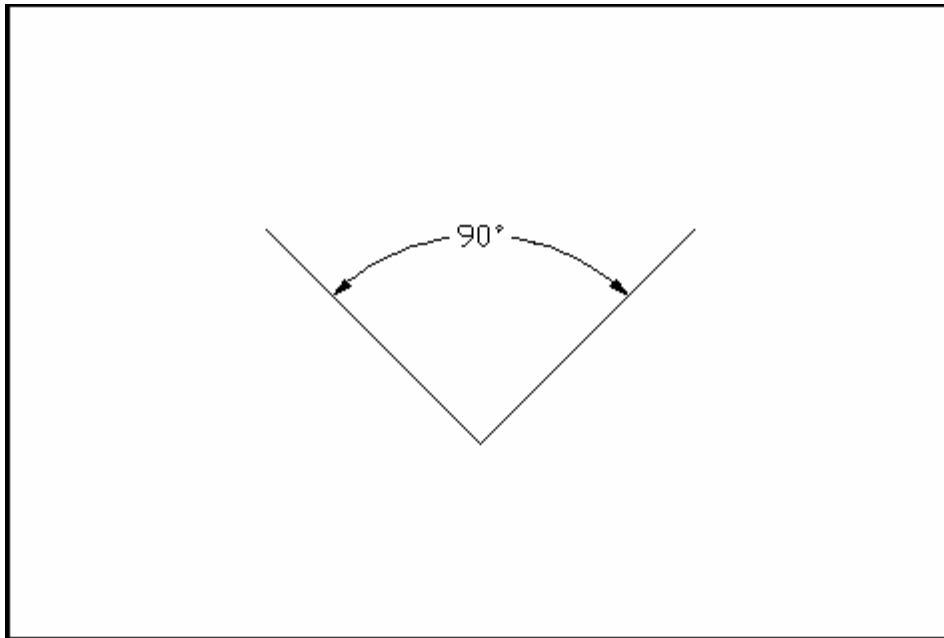

AutoCAD 2D Tutorial

Continued and Baseline Dimensions 26.5

1. **Choose** Dimension, Continue or Baseline.

or

2. **Click** the Continue or Baseline Dimensions command from the toolbar.



or

3. **Type** DIM at the command prompt.

Command: **DIM**

Dim: **CONTINUE** or **BASELINE**

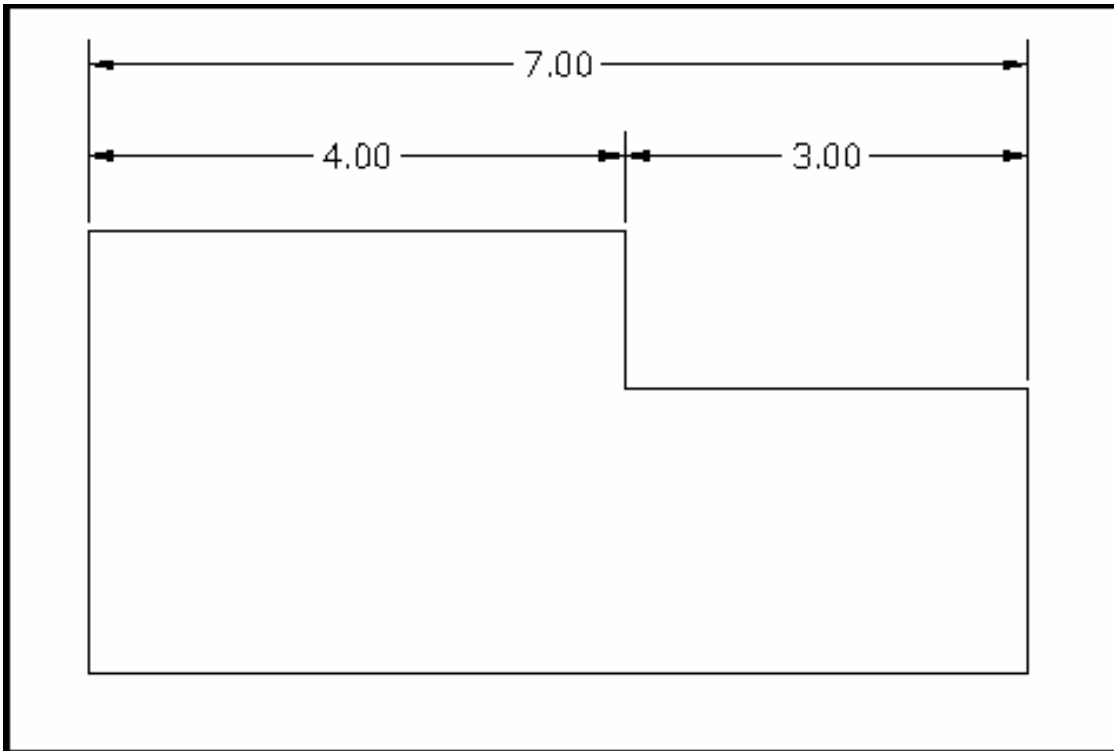

AutoCAD 2D Tutorial

Leaders 26.6

1. **Choose** Dimension, Leader...
or
2. **Click** the Leader icon from the Dimension toolbar.



- or**
3. **Type** QLEADER at the command prompt.
Command: **QLEADER**

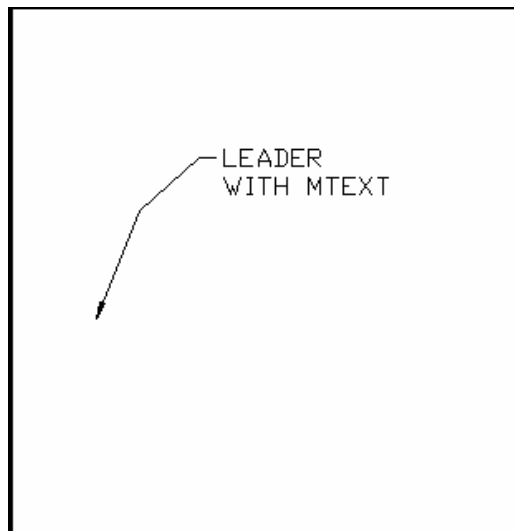

AutoCAD 2D Tutorial

Leader Settings

1. **Type** QLEADER at the command prompt.
Command: **QLEADER**
2. **Type** “S” at the QLEADER prompt to change the leader settings.
3. **Choose** a setting from the following dialog box.

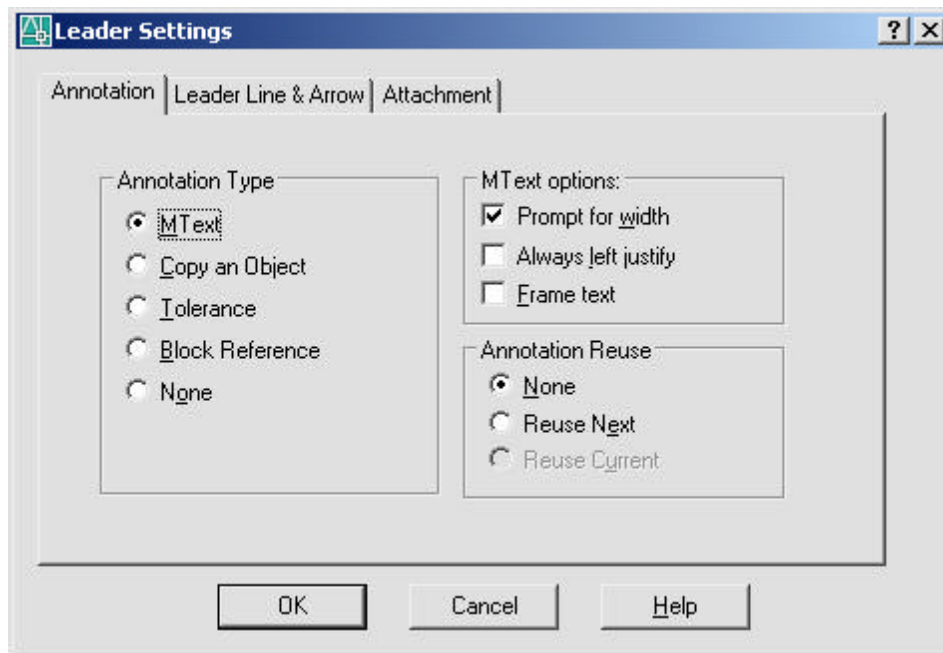

AutoCAD 2D Tutorial

Quick Dimensions 26.7

Quickly creates dimension arrangements from the geometry you select.

1. **Choose** Dimension, QDIM.
or
2. **Click** the Quick Dimension icon from the Dimensions toolbar.



3. **Type** QDIM at the command prompt.
Command: **QDIM**
4. **Pick** the objects to dimension.

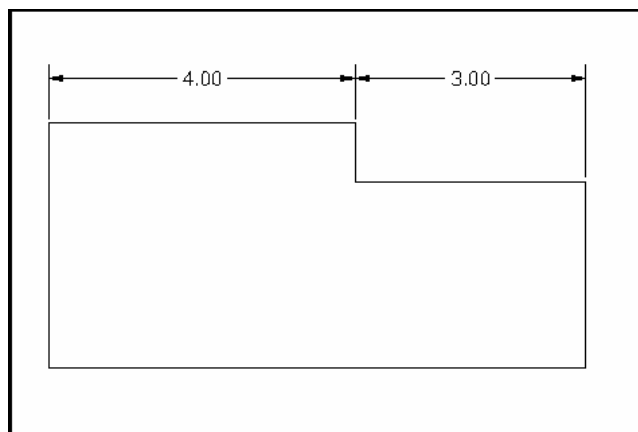
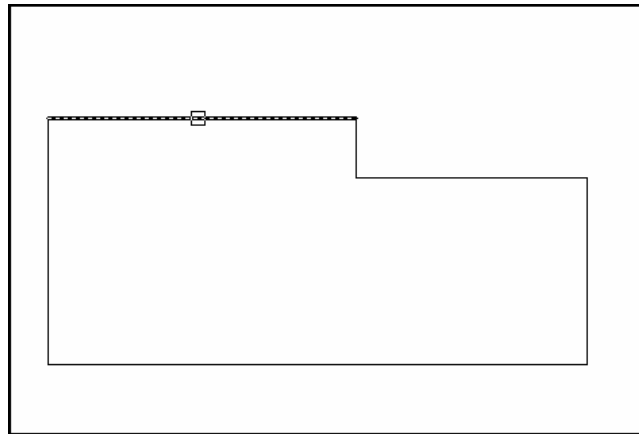

Modifying Dimensions 26.8

DDEDIT

1. **Choose** Modify, Object, Text.
2. **Choose** the dimension text to modify.

TIP: The actual dimension is placed in brackets <>. Text can be placed in front of or behind these brackets. If text is placed between the brackets, the dimension loses its associative properties.

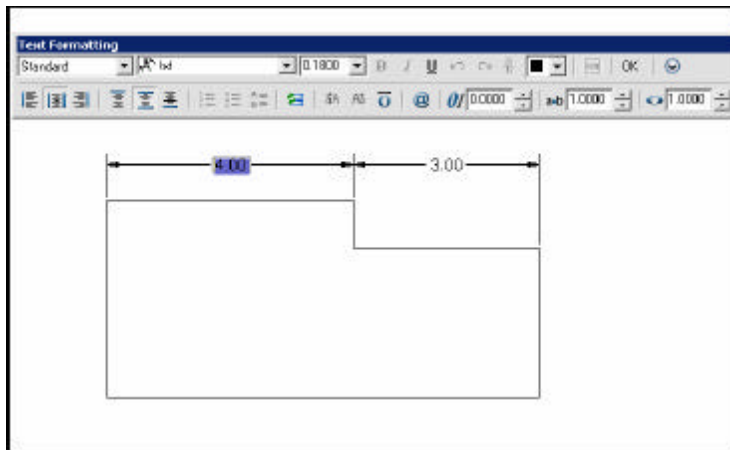

Stretching Dimensions

1. **Choose** Modify, Stretch.
2. **Choose** a crossing window around the area to stretch. Be sure to include the dimension endpoints.

AutoCAD 2D Tutorial

DIMTEDIT

Moves and rotates dimension text

1. **Choose** Dimension, Align Text. or
2. **Type** DIMTEDIT at the command prompt.

Command: **DIMTEDIT**

Select dimension: select object

Enter text location (Left / Right / Angle):

Dimension Edit Commands

HOMetext	Moves the Dimension text back to its home (default) position.
NEWtext	Modifies the text of the Dimensions.
Rotate	Rotates dimension text.
OBlique	Sets the obliquing angle of Dimension extension lines.
OVerride	Overrides a subset of the Dimension variable settings.
UPdate	Redraws the Dimensions as directed by the current settings of all dimensioning variables.

Ordinate Dimensions 26.9

1. **Choose** Dimension, Ordinate
or
2. **Type** DIMORDINATE at the command prompt.
Command: Dimordinate

Chapter 27
Dimension Styles

AutoCAD 2D Tutorial

Creating Dimension Styles 27.1

1. **Choose** Format, Dimension Style...
or
2. **Choose** Dimension, Style.
or
3. **Choose** Dimension Style icon from the Dimension Style toolbar.



4. **Type** DDIM at the command prompt
Command:**DDIM**
5. **Choose** New... from the dialog box.
6. **Create** a new style from the existing styles.

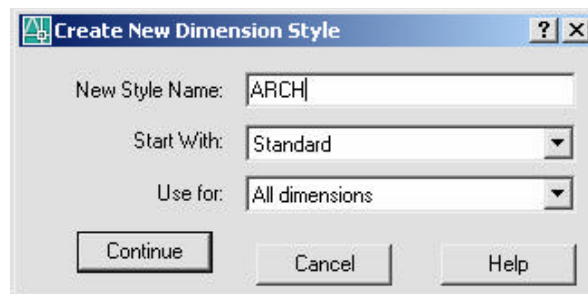

7. **Click** the Continue button.

TIP:

All dimension variables except for DIMSHO and DIMASO can be saved as a style.

AutoCAD 2D Tutorial

Lines and Arrows 27.2

Edits Dimension Lines, Extension Lines, and Arrows.

1. **Pick** the Lines and Arrows tab from the Dimension Variables and Styles dialog box.

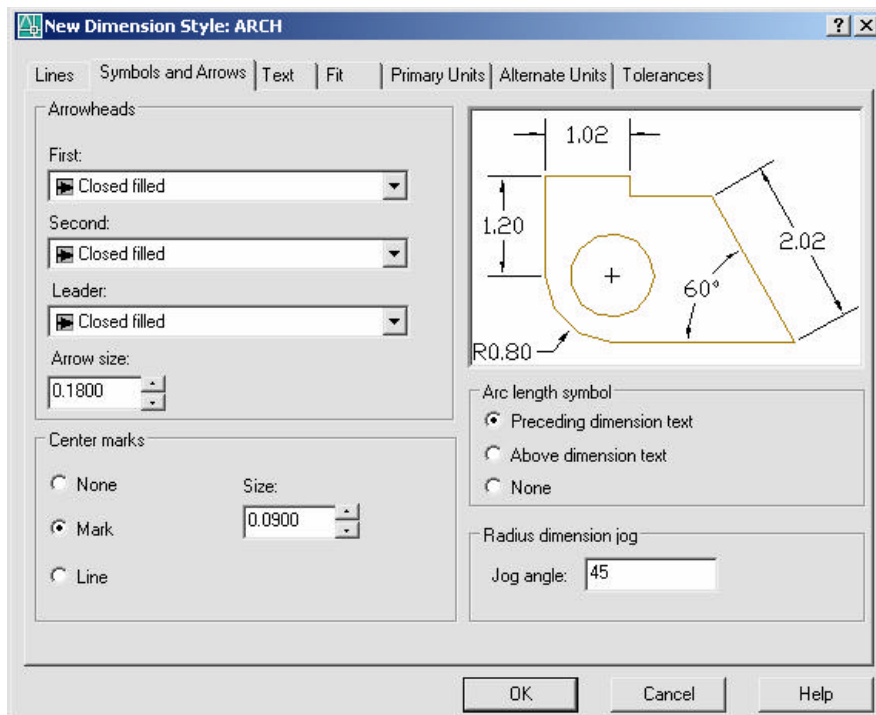
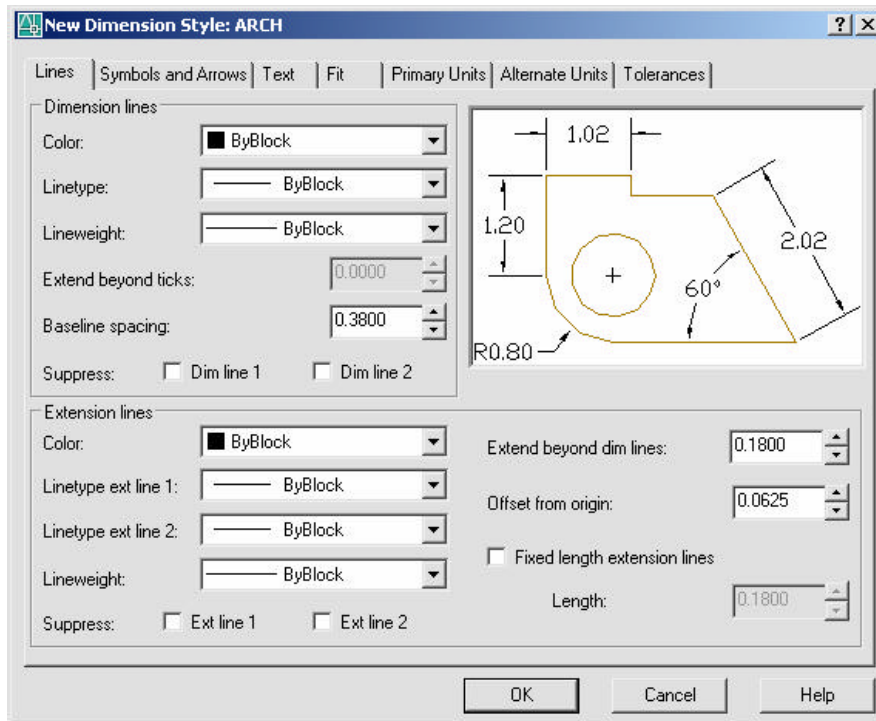

AutoCAD 2D Tutorial

Text 27.3

Edits Text Appearance, Text Placement and Text Alignment.

1. **Pick** the Text tab from the Dimension Variables and Styles dialog box.

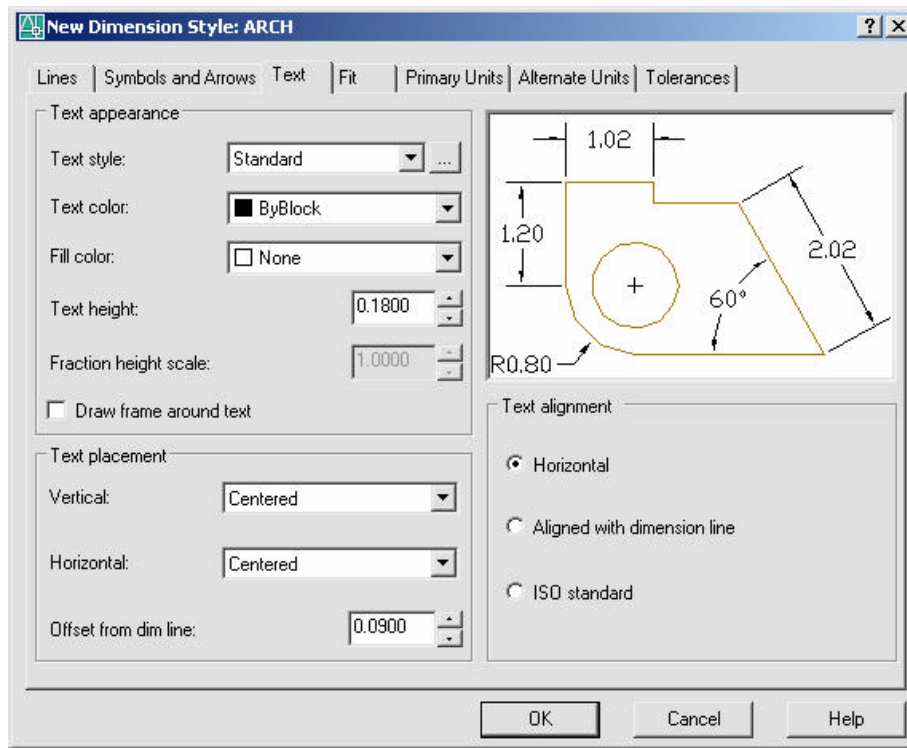

AutoCAD 2D Tutorial

Primary Units 27.4

Edits Unit options for dimension's primary units.

1. **Pick** the PRIMARY UNIT tab from the Dimension Variables and Styles dialog box.

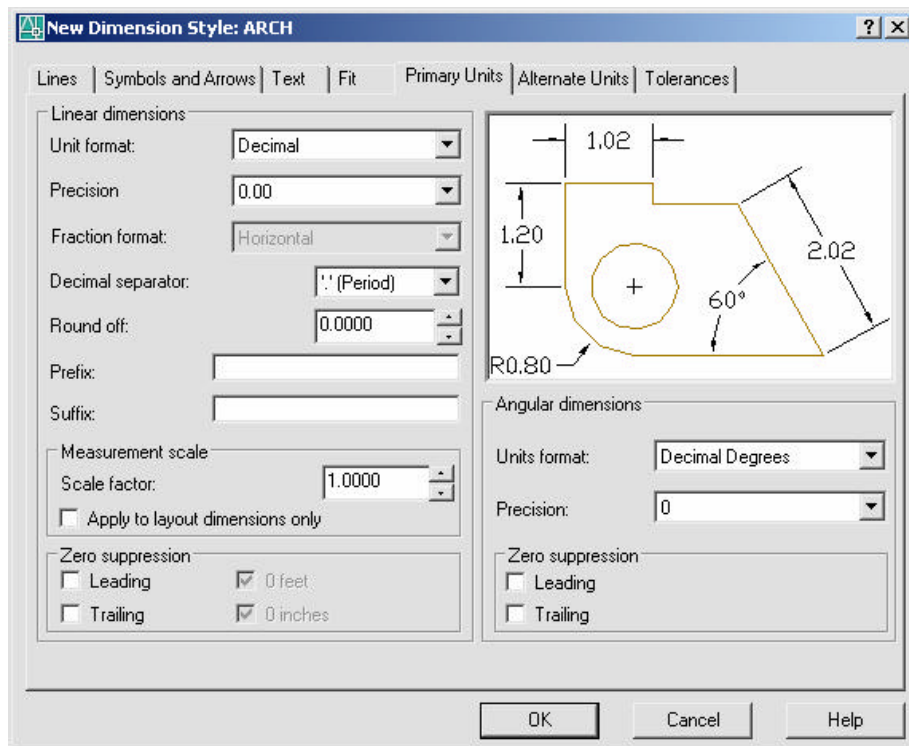

AutoCAD 2D Tutorial

Alternate Units 27.5

Edits Unit options for dimension's alternate units.

1. **Pick** the ALTERNATE UNIT tab from the Dimension Variables and Styles dialog box.

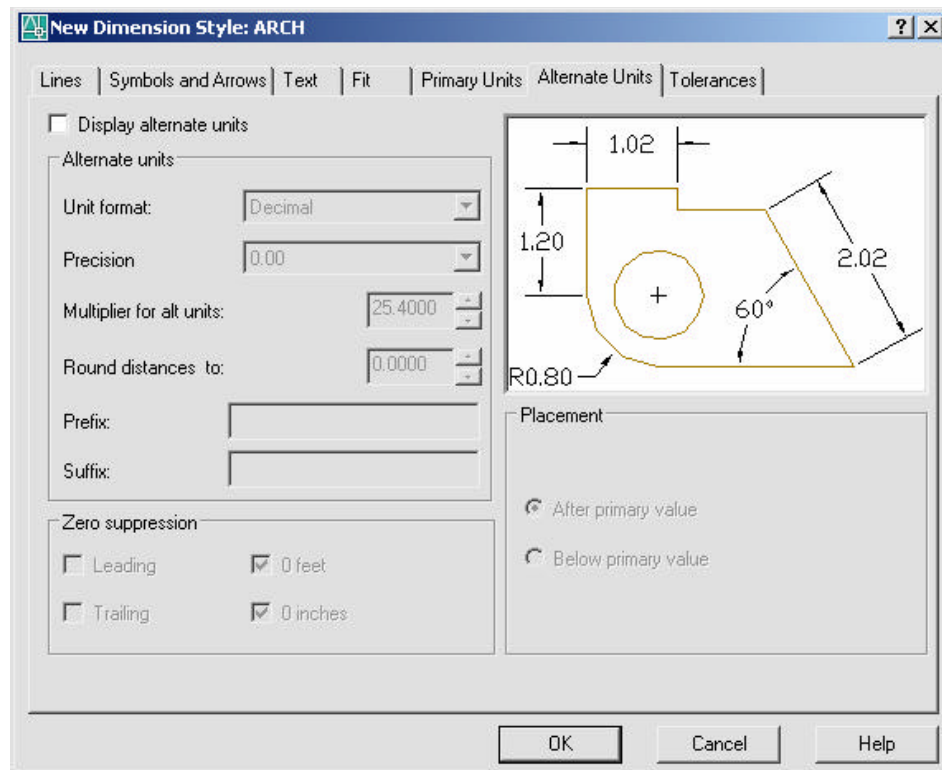

AutoCAD 2D Tutorial

Tolerances 27.6

Edits Unit options for tolerances.

1. **Pick** the TOLERANCES tab from the Dimension Variables and Styles dialog box.

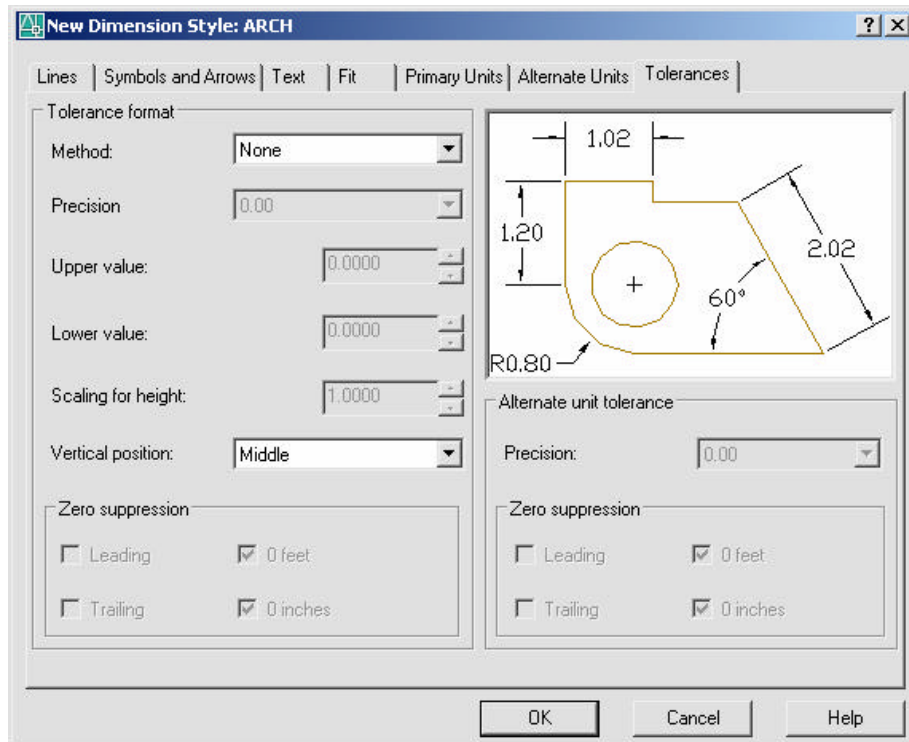

AutoCAD 2D Tutorial

Fit 27.7

Edits Unit options for fitting dimensions and dimension scales.

1. **Pick** the FIT tab from the Dimension Variables and Styles dialog box.

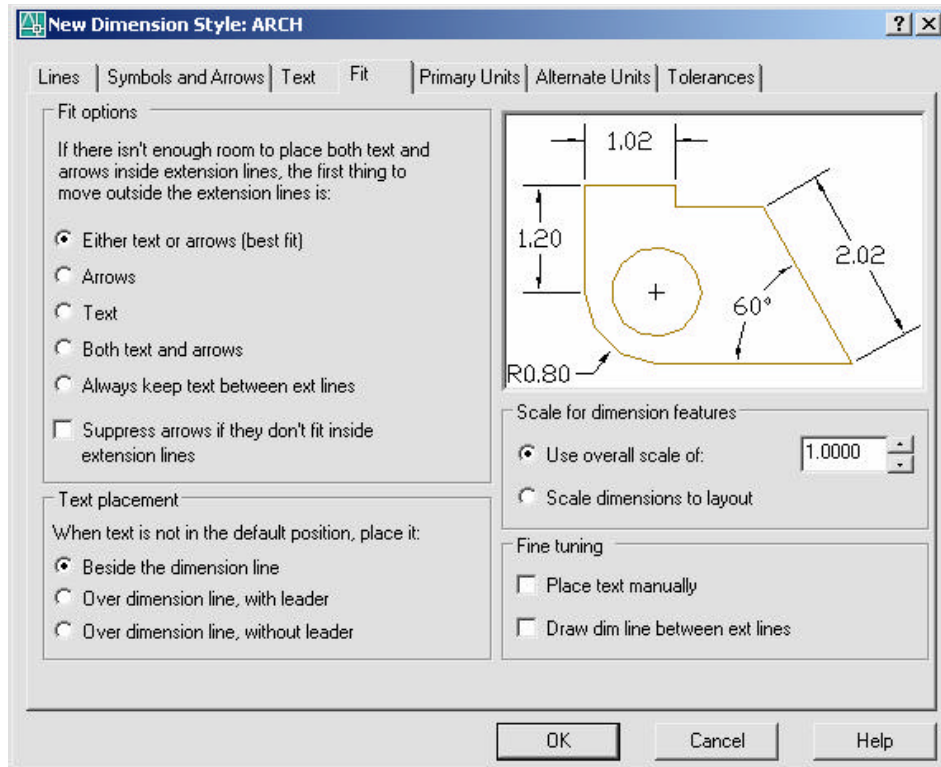

AutoCAD 2D Tutorial

Dimscale 27.8

Edits Unit options for fitting dimensions and dimension scales.

1. **Pick** the FIT tab from the Dimension Variables and Styles dialog box.

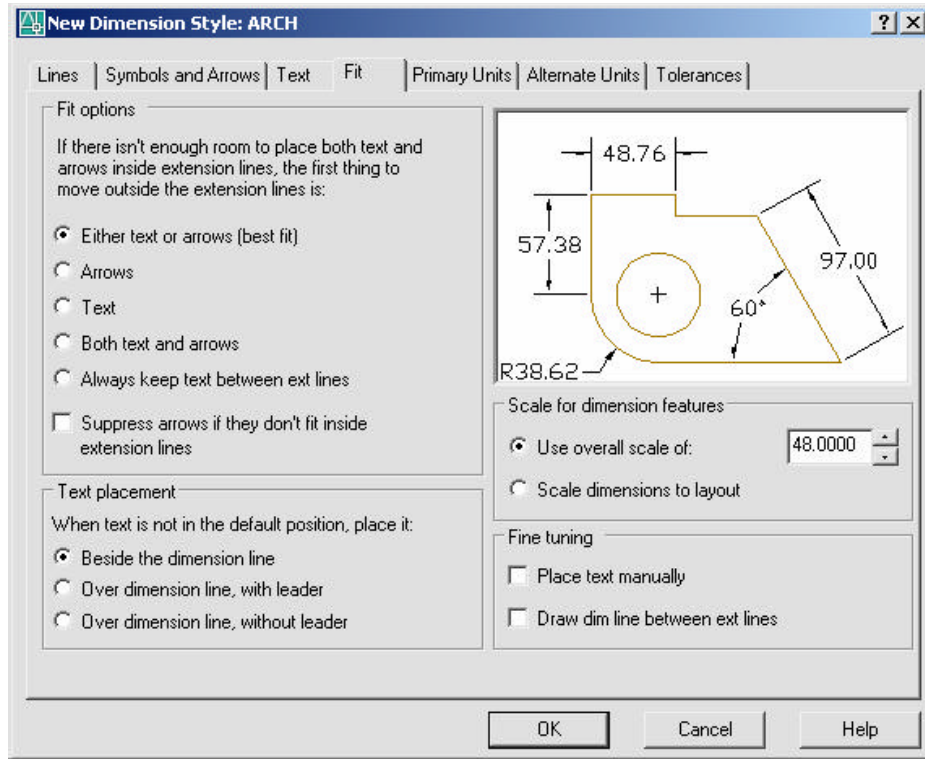

AutoCAD 2D Tutorial

Dimension Override 27.9

1. **Choose** Dimension, Override.
2. **Type** a dimension setting to change (i.e. DIMSE1 which suppresses the first extension line).
Command: **_dimoverride**
Enter dimension variable name to override or [Clear overrides]: **dimse1**
3. **Set** the new value.
Enter new value for dimension variable <Off>: **on**
4. **Press** enter.
5. **Pick** the dimension to override.

AutoCAD 2D Tutorial

Dimension Variables 27.10

1. Type **SETVAR** at the command prompt.

Command: **SETVAR**

Enter variable name or [?]: ?

Enter variable(s) to list <*>: **dim***

DIMADEC	0
DIMALT	OFF
DIMALTD	2
DIMALTF	25.4000
DIMALTRND	0.0000
DIMALTTD	2
DIMALTTZ	0
DIMALTU	2
DIMALTZ	0
DIMAPOST	""
DIMASO	ON
DIMASSOC	1
DIMASZ	0.1800
DIMATFIT	3
DIMAUNIT	0
DIMAZIN	0
DIMBLK	"ArchTick"
DIMBLK1	""
DIMBLK2	""
DIMCEN	0.0900
DIMCLRD	0
DIMCLRE	0
DIMCLRT	5
DIMDEC	1
DIMDLE	0.1250
DIMDLI	0.5000

AutoCAD 2D Tutorial

DIMDSEP	."	
DIMEXE	0.1800	
DIMEXO	0.1250	
DIMFIT	3	
DIMFRAC	0	
DIMGAP	0.0900	
DIMJUST	0	
DIMLDRBLK	"Open90"	
DIMLFAC	1.0000	
DIMLIM	OFF	
DIMLUNIT	4	
DIMLWD	-2	
DIMLWE	-2	
DIMPOST	""	
DIMRND	0.0000	
DIMSAH	OFF	
DIMSCALE	1.0000	
DIMSD1	OFF	
DIMSD2	OFF	
DIMSE1	OFF	
DIMSE2	OFF	
DIMSHO	ON	
DIMSOXD	OFF	
DIMSTYLE	"ARCH"	(read only)
DIMTAD	1	
DIMTDEC	1	
DIMTFAC	1.0000	
DIMTIH	ON	
DIMTIX	OFF	
DIMTM	0.0000	

AutoCAD 2D Tutorial

DIMTMOVE	0
DIMTOFL	OFF
DIMTOH	ON
DIMTOL	OFF
DIMTOLJ	1
DIMTP	0.0000
DIMTSZ	0.0000
DIMTVP	0.0000
DIMTXSTY	"Standard"
DIMTXT	0.1800
DIMTZIN	0
DIMUNIT	4
DIMUPT	OFF
DIMZIN	0

Chapter 28

Views and Viewports

AutoCAD 2D Tutorial

Named Views 28.1

Ddview Command

1. **Choose** View, Named Views...

or

2. **Click** the Named View icon from the View toolbar.



3. **Type** DDVIEW at the command prompt.

Command: **DDVIEW**

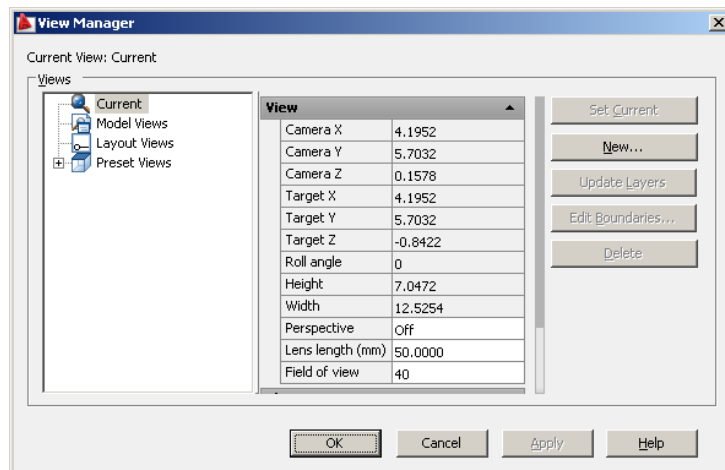

4. **Choose** the NEW button.
5. **Type** a view name.
6. **Choose** Current display or Define Window.

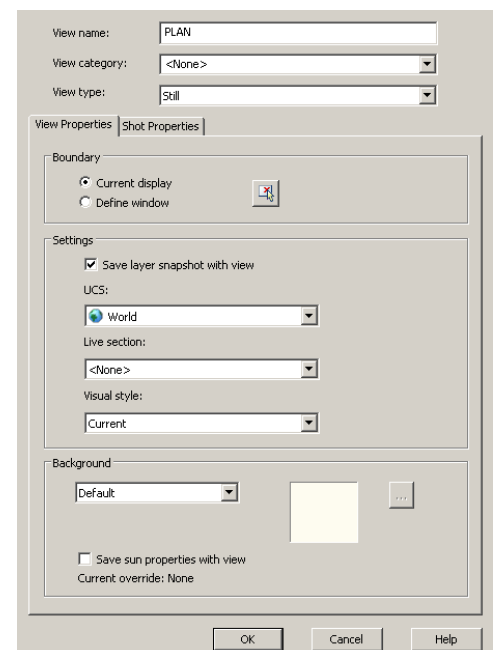

AutoCAD 2D Tutorial

Typing the View Command

1. **Type** View at the command prompt. Command: **-VIEW**
2. **Type** One of the following view options:
?/Delete/Restore/Save/Window:

View options:

- | | |
|----------------|--|
| ? | Lists the named views for this drawing |
| Delete | Deletes the named view |
| Restore | Displays the specified view |
| Save | Attaches a name to the current view of the drawing |
| Window | Attaches a name to specified window |

Plotting Named Views

The screenshot shows the 'Plot' dialog box in AutoCAD. It is divided into several sections:

- Page setup:** Name: <None> (dropdown), Add... button.
- Printer/plotter:** Name: None (dropdown), Properties... button, Plotter: None, Where: Not applicable, Description: The layout will not be plotted unless a new plotter configuration name is selected. Plot to file. A diagram shows a plot area of 8.5" x 11.0".
- Paper size:** ANSI A (8.50 x 11.00 Inches) (dropdown).
- Number of copies:** 1 (spin box).
- Plot area:** What to plot: View (dropdown), PLAN (dropdown).
- Plot offset (origin set to printable area):** X: 0.000000 inch, Y: 0.000000 inch, Center the plot.
- Plot scale:** Fit to paper, Scale: Custom (dropdown), 1 inches (spin box), 1.318 units (spin box), Scale lineweights.

Buttons at the bottom: Preview..., Apply to Layout, OK, Cancel, Help, and a right arrow button.

AutoCAD 2D Tutorial

Viewports 28.2

Vports Command

1. **Choose** View, Viewports, New Viewports...
2. **Choose** one of the viewports configurations
3. **Click** OK.

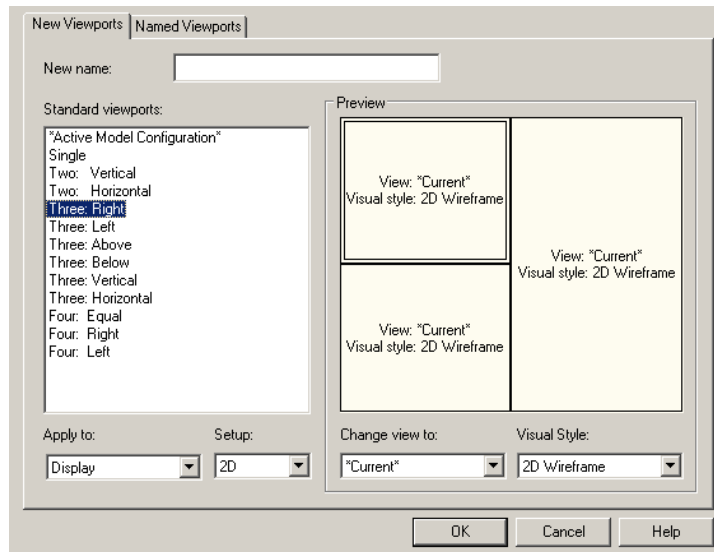

4. **Click** once in each vport to make it active.
5. **Type** a ZOOM option in each viewport.

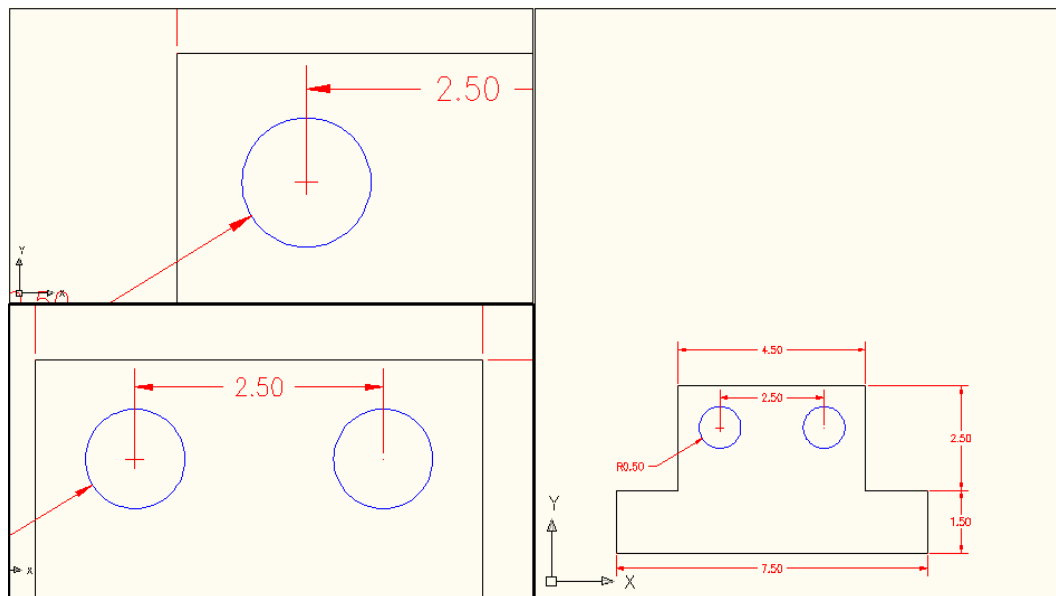

AutoCAD 2D Tutorial

Viewport options

New Name	Gives a name to a viewport
Restore	Restores an original viewport
Delete	DEL deletes a viewport
Join	Joins two viewports together
Single	Creates one viewport in the drawing

TIPS:

Viewports can be named and restored later.

AutoCAD plots only the current viewport.

Chapter 29
Model Space and Paper
Space

AutoCAD 2D Tutorial

Creating a Layout 29.1

1. **Choose** the Layout1 TAB at the bottom of the screen.

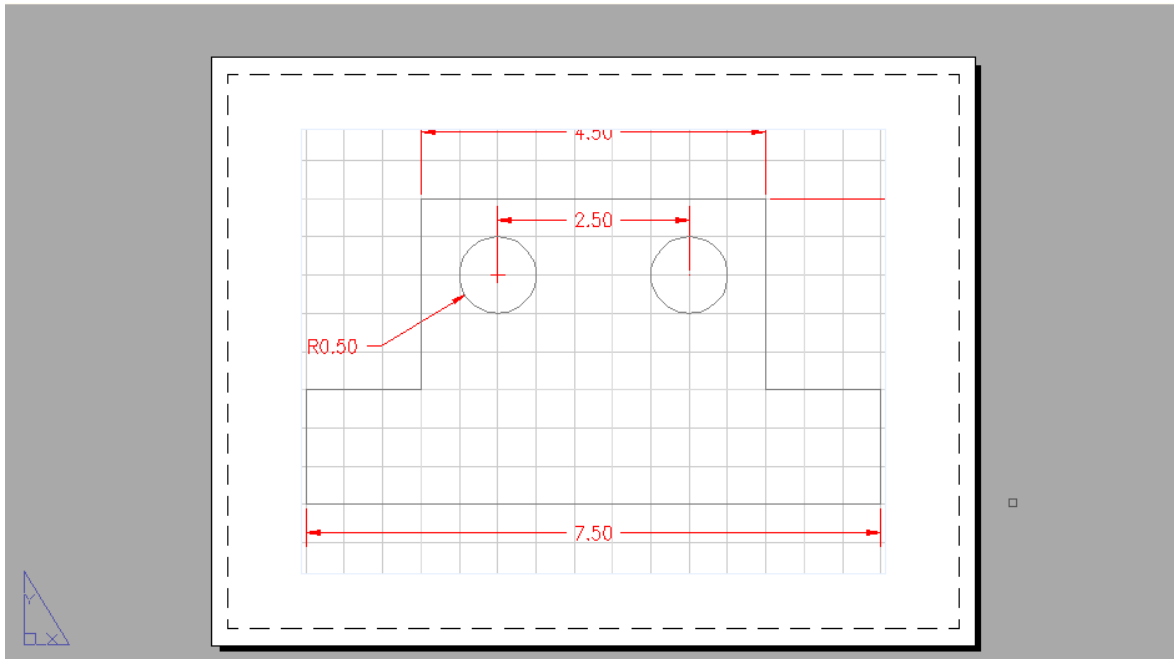
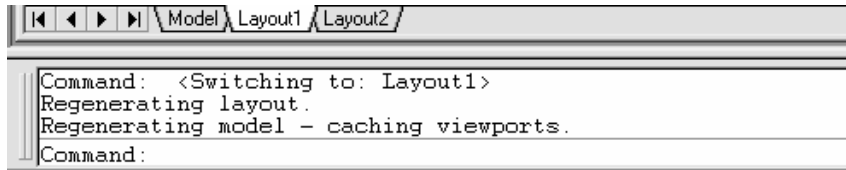

2. **Right-click** Layout 1 to change the name and other properties of a layout

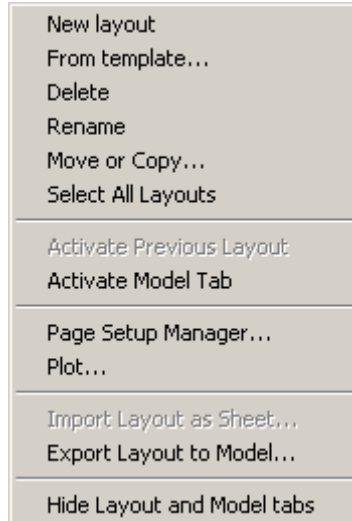

AutoCAD 2D Tutorial

Creating Multiple Layouts 29.2

1. **Choose** the Layout2 TAB at the bottom of the screen.

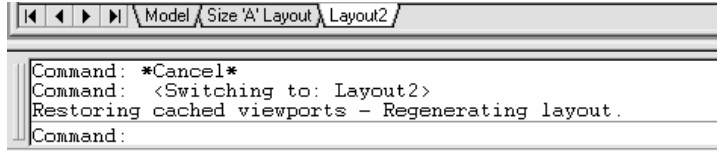

2. **Change** the name of the layout.
3. **Change** the remaining Layout options for page setup and plots.

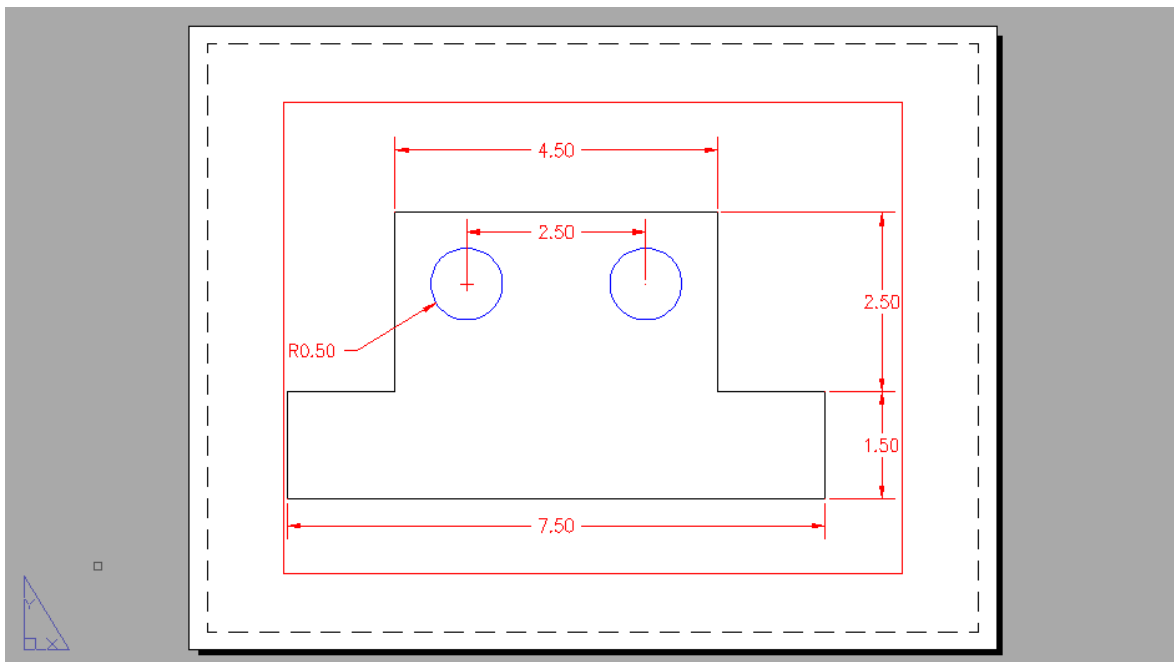

AutoCAD 2D Tutorial

Quick View Layouts 29.3

1. **Choose** Quick View Layouts from the status bar.



2. **Choose** a layout to view.

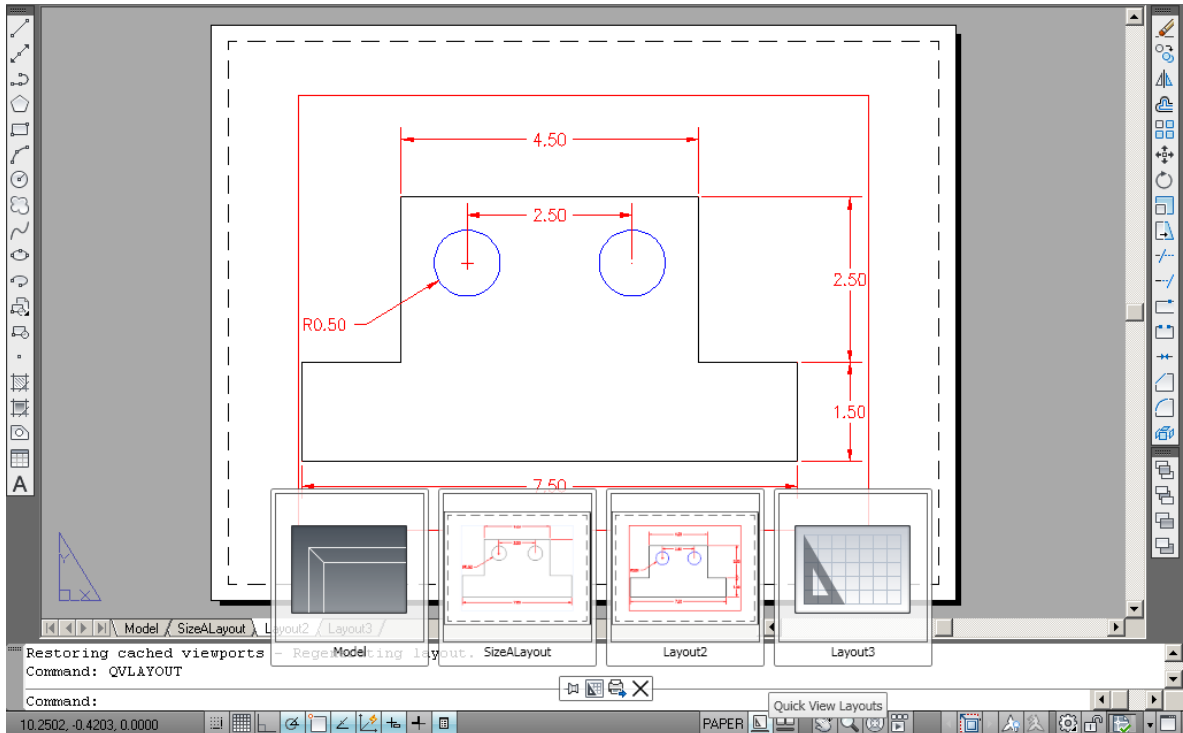

AutoCAD 2D Tutorial

Mview Command 29.4

- The MVIEW command controls the size and position of the mview viewports (from now on called mviews). Mview is to tilemode = 0 as vports is to tilemode = 1.
- Use mview when you would like to see a view of the model.
- Pspace mode must be active to use mview. AutoCAD will automatically switch to pspace when you issue the mview command.
- The default mview option is "<<first point>>" To use this option, pick a point which represents one corner of the mview. At the "other corner" prompt, pick a point which represents the opposite corner of the mview.

1. **Choose** View, Viewports, 1 Viewport.

or

2. **Type** Type MVIEW at the command prompt.

Command: **MVIEW or MV**

ON/OFF/Hideplot/Fit/2/3/4/Restore/<<First Point>>:

P1

Other corner: **P2**

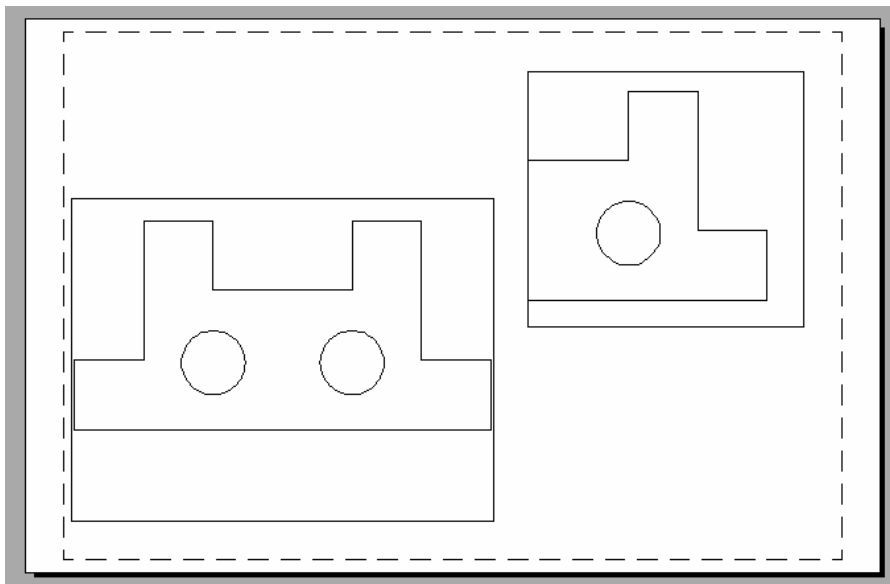

TIP: Mviews should be created on their own layers in order to be turned ON/OFF.

AutoCAD 2D Tutorial

Irregular Shaped Viewports 29.5

1. **Draw** a shape in Paper Space (e.g. circle, polygon, ellipse)
2. **Choose** View, Viewports, Object
3. **Choose** the object to make a viewport.

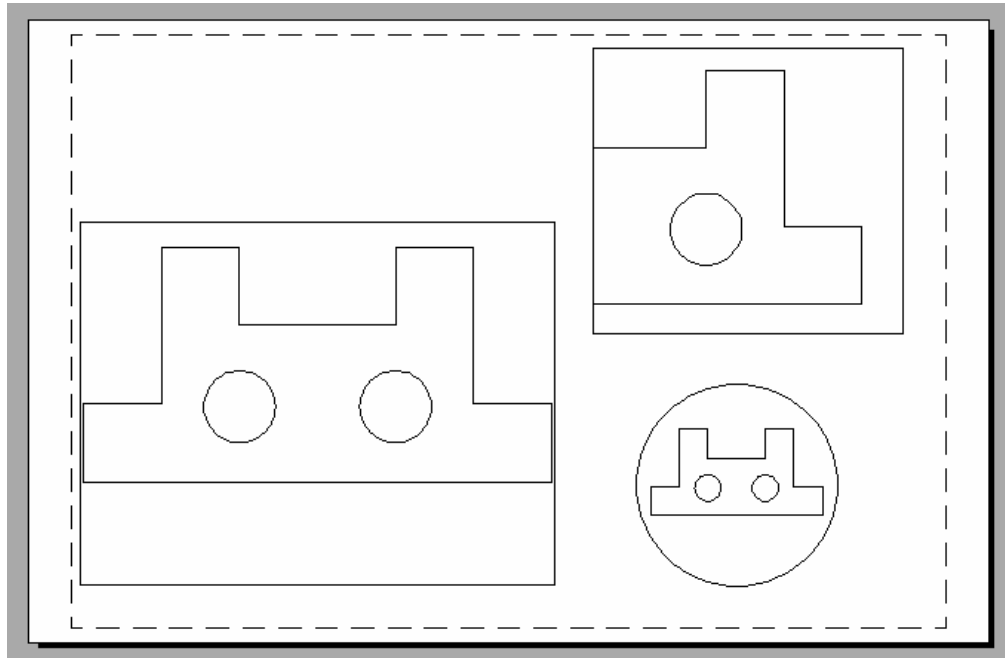

AutoCAD 2D Tutorial

Model Space 29.6

MSPACE (model space) can only be activated if there is at least one mview. To enter model space mode use "MSPACE".

1. **Type** MSPACE at the command prompt.

Command: **MSPACE** or **MS**

or

2. **Double-Click** the word "PAPER" on the Status Bar to toggle to model space.



Notice the ucsicon will appear in each of the mviews when you enter model space.

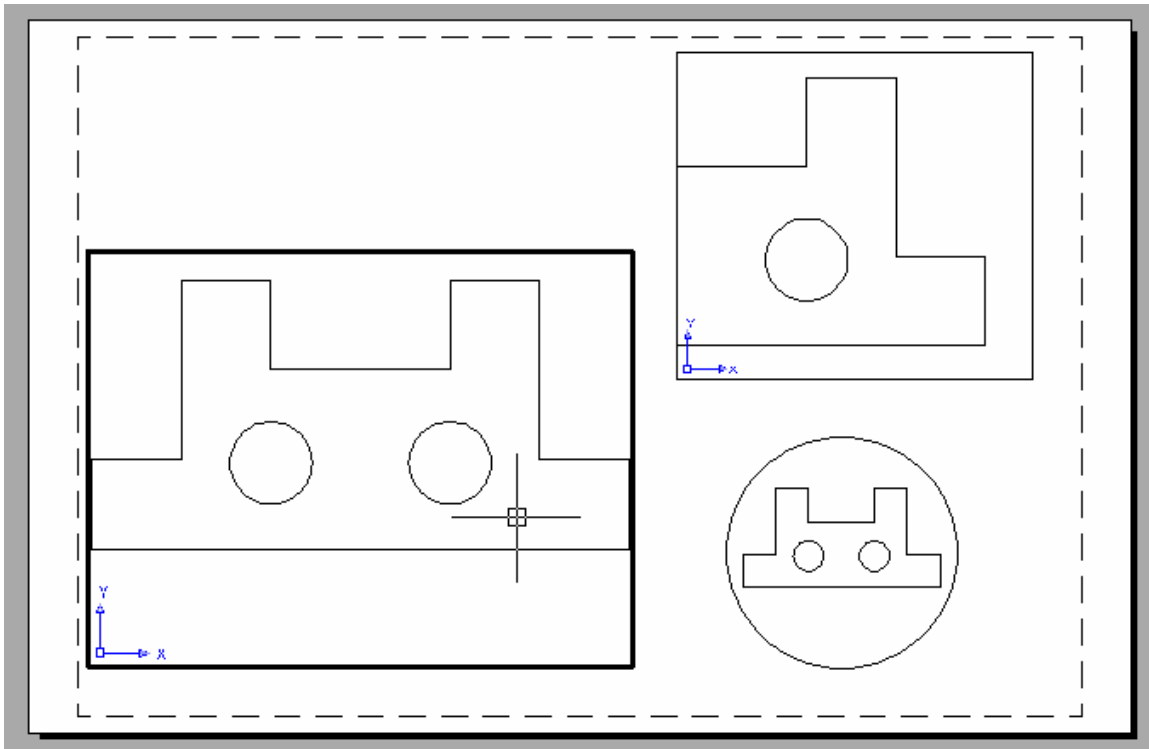

AutoCAD 2D Tutorial

Paper Space 29.6

PSPACE mode should be entered to create a border, a title, mviews, and annotations only. This environment is used to lay out a 2 dimensional working drawing suitable for plotting. When you plot from pspace, you should plot 1=1.

1. **Type** PSPACE at the command prompt.
Command: **PSPACE** or **PS**
2. **Double-Click** the word "MODEL" on the Status Bar to toggle to paper space.

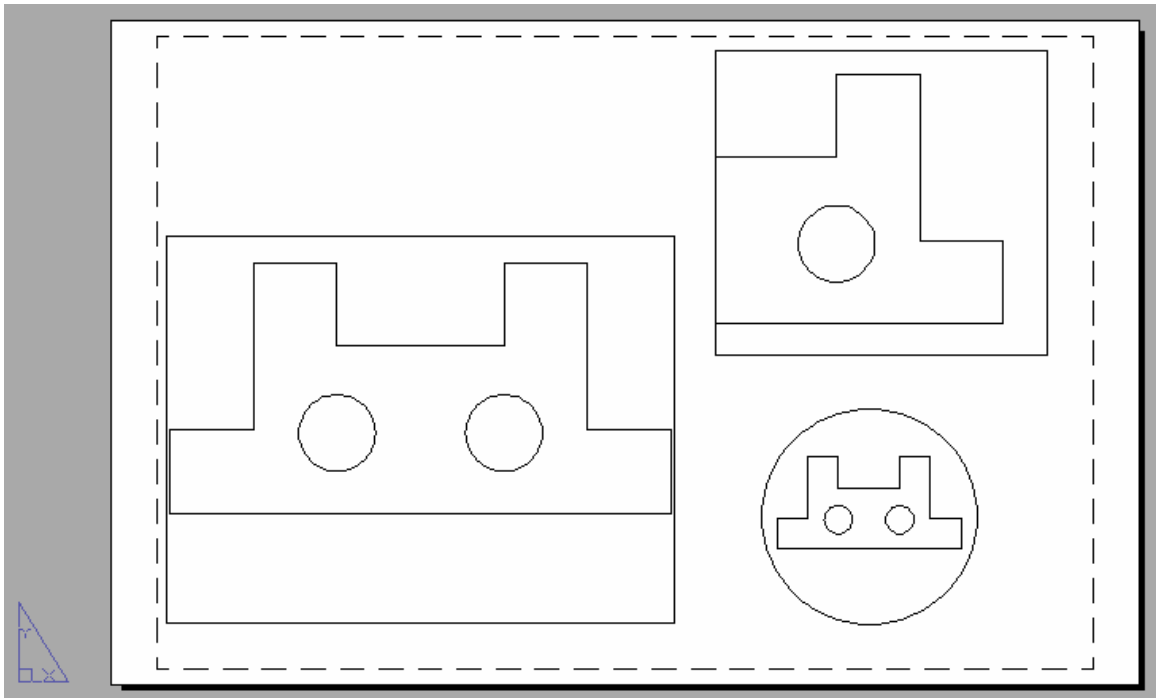

Notice the "Paper" in the status line and the pspace icon.



AutoCAD 2D Tutorial

Scales - Zooming in Model Space 29.7

- Use ZOOM "XP" to zoom the model a certain factor of the paper.
- If you enter a value followed by xp, AutoCAD specifies the scale relative to paper space units. For example, entering .5xp displays model space at half the scale of paper space units.
- If you want to plot the model at 1/4"=1', type ZOOM 1/48XP . If you want to plot a part at 3 times, type ZOOM 3XP.
- Views can also be shown in 3D by using the VPOINT command.

1. **Type** MS at the command prompt to enter Model Space for each individual viewport.
2. **Type** ZOOM at the command prompt. Command: ZOOM All/Center/Dynamic/Extents/Previous/ Scale(X/XP)/ Window/<Realtime>: **3XP**



You can also change the scale from the Viewports Toolbar.

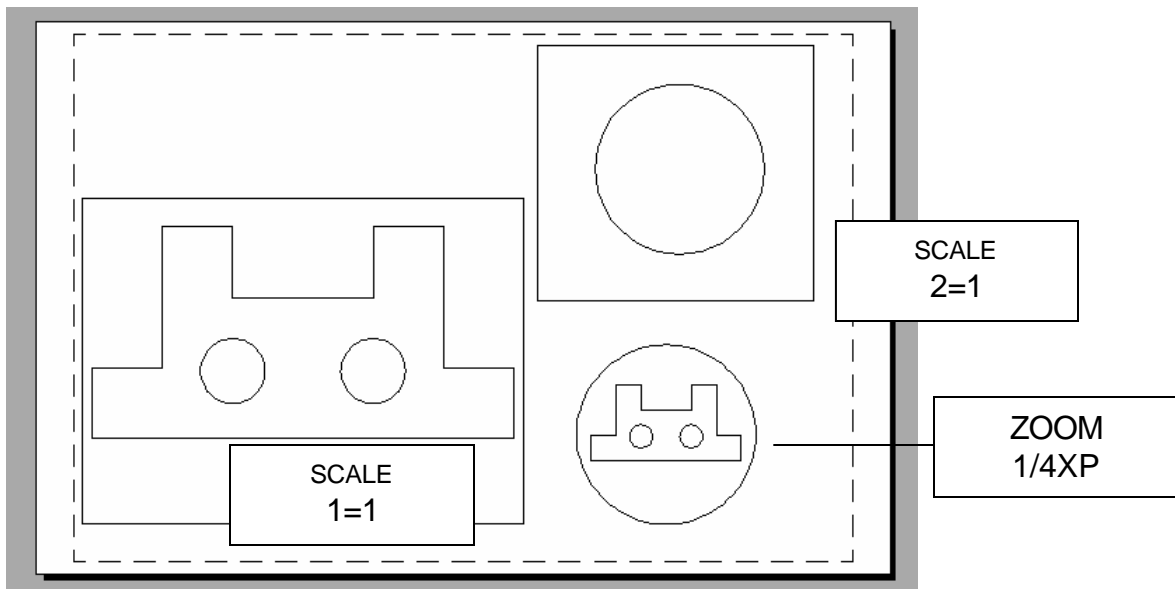

AutoCAD 2D Tutorial

Adding Text in Paper Space 29.8

Title block text and miscellaneous text can be added in Paper Space.

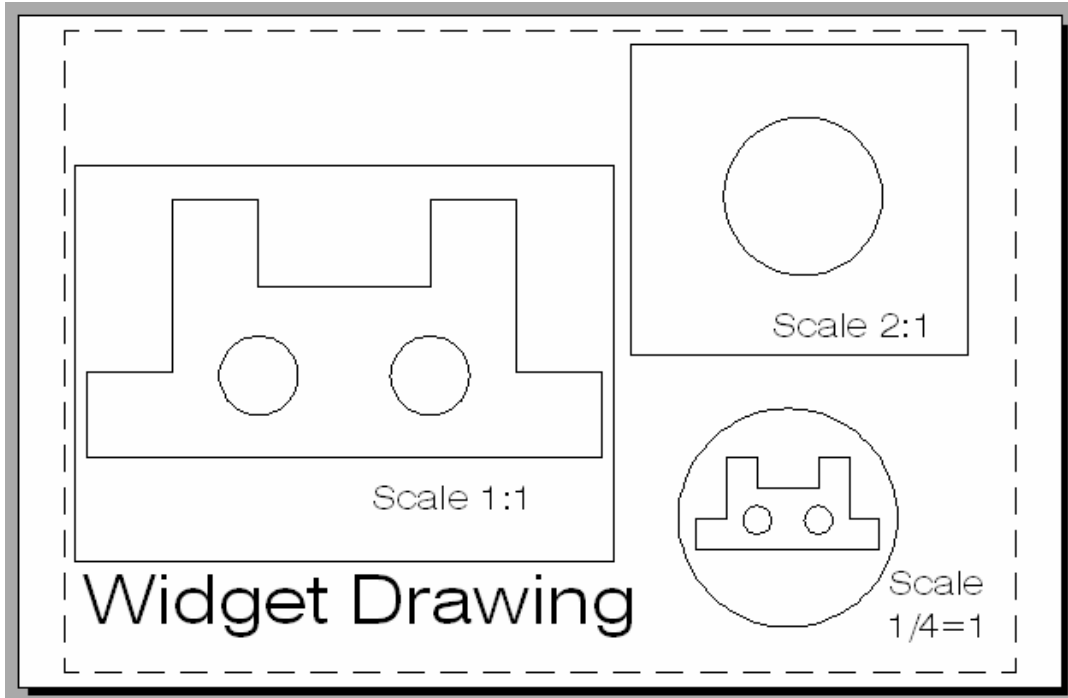

AutoCAD 2D Tutorial

Plotting in Paper Space 29.9

- Plotting all MVIEWES should be done from Paper Space not from Model Space.
- When you plot from pspace, you should plot1=1.
- For hidden line removals, remember to use the HIDEPLOT option in the MVIEW command.
- Once a ZOOM SCALE has been defined, do not zoom again before plotting. You can change the display with the PAN command.

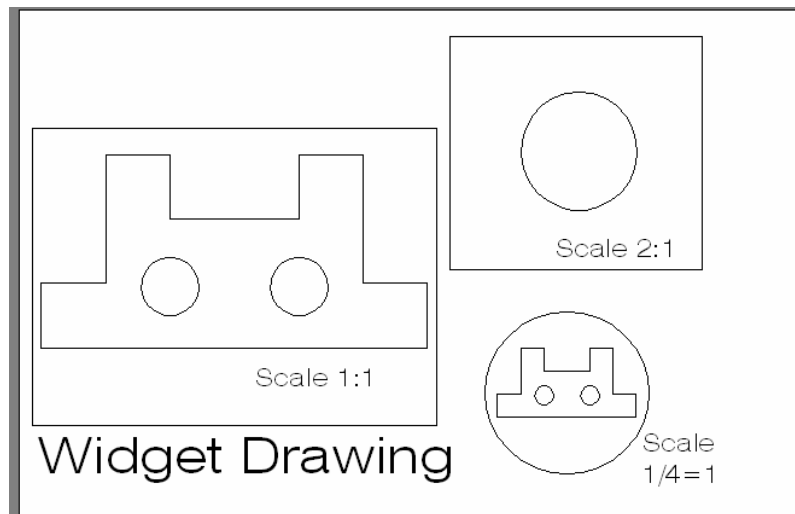
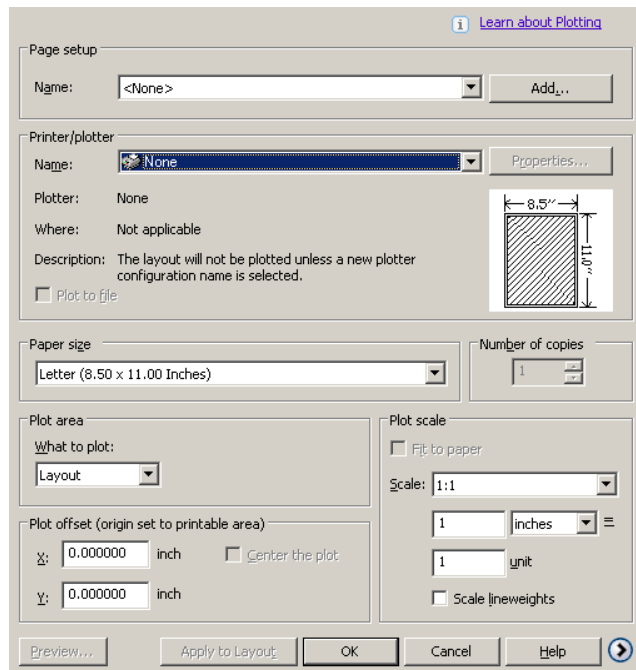

AutoCAD 2D Tutorial

Layout Wizard 29.10

1. **Choose** Insert, Layout, Layout Wizard
2. **Change** the various options in the Layout Wizard.

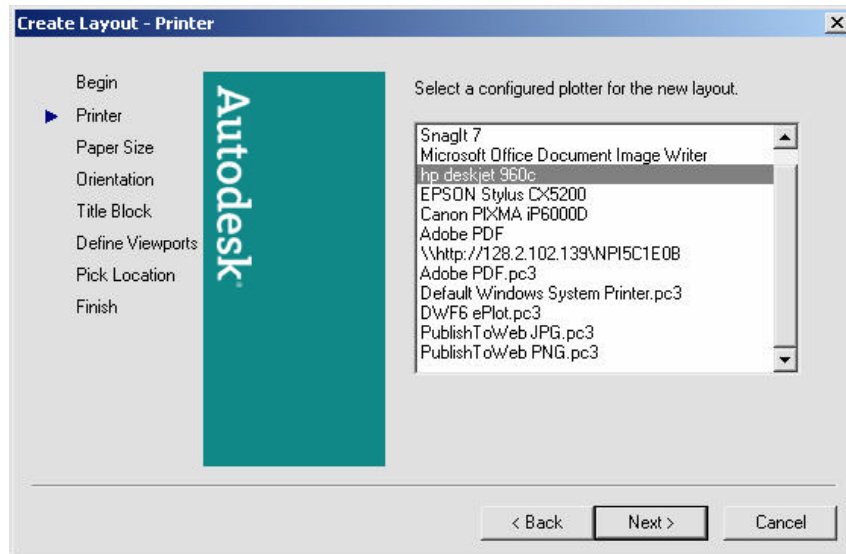
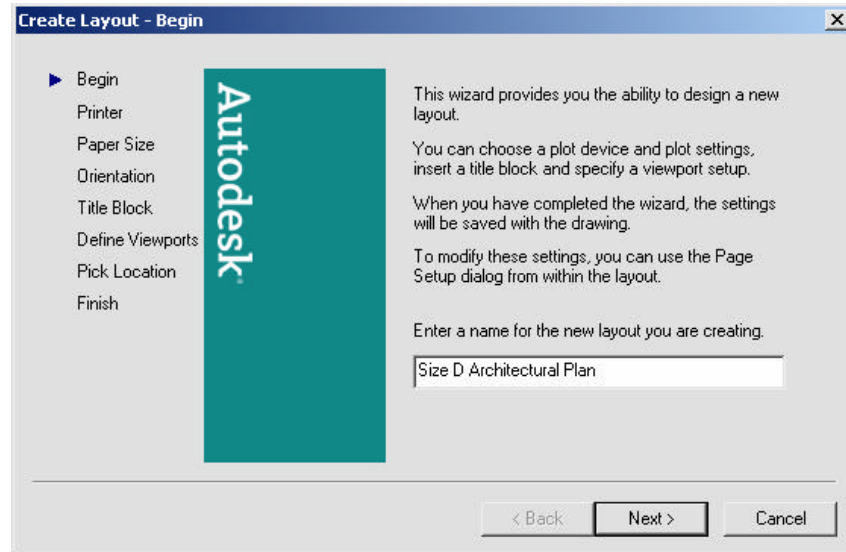

AutoCAD 2D Tutorial

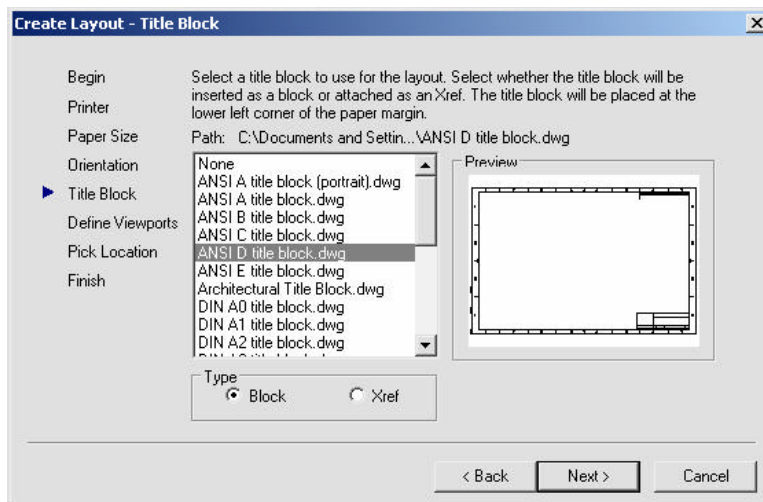
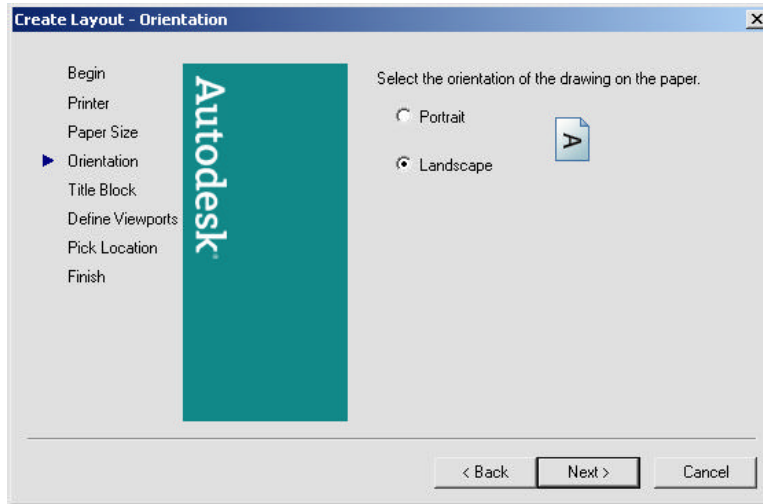
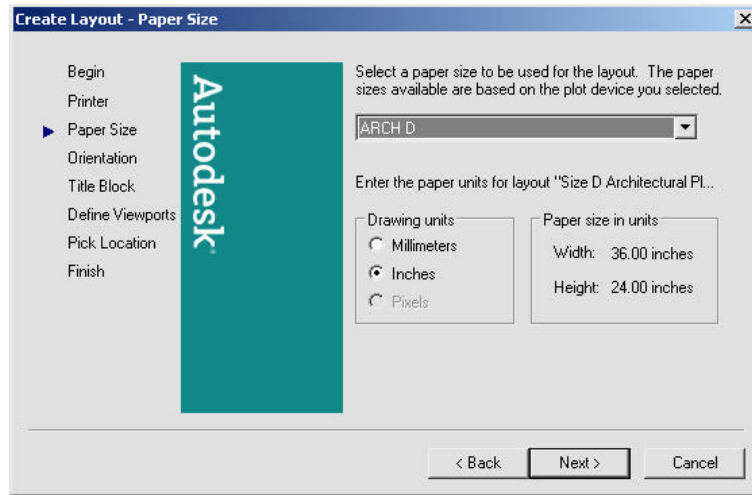

AutoCAD 2D Tutorial

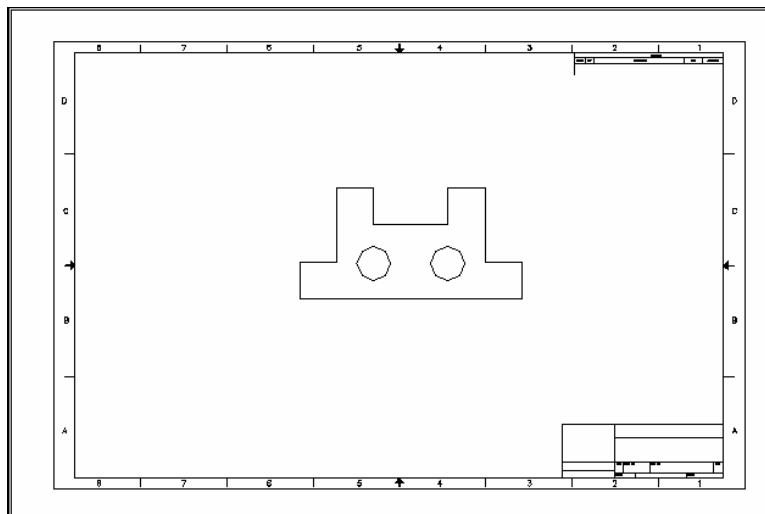
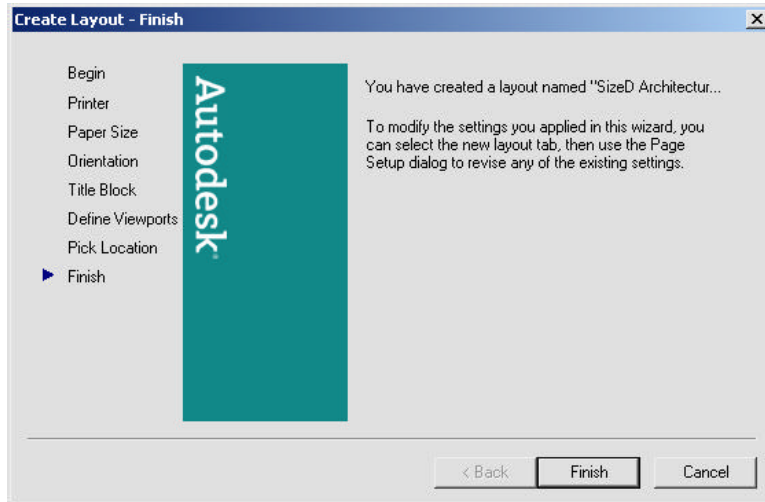
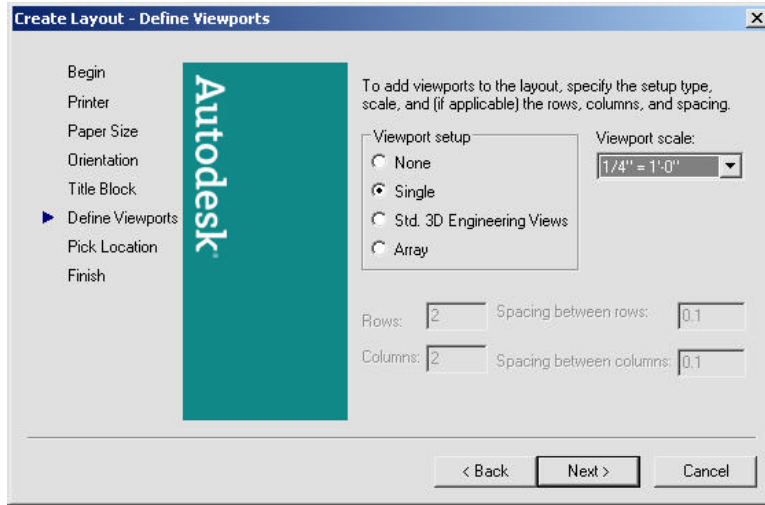

AutoCAD 2D Tutorial

Tilemode 29.11

Tilemode is an AutoCAD system variable which can be set to 0 or 1. When tilemode is set to "1", viewports act as they traditionally did, like floortiles. Each viewport butts up against the next. The viewports fill the screen. They can only be plotted one as a time. These traditional viewports are known as "tiled areas of the screen". This is the default setting.

1. **Type**

TILEMODE at the command prompt.

Command: **TILEMODE**

New value for tilemode <1> : **Press ENTER**

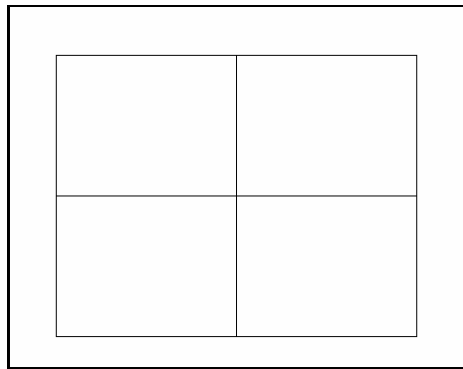

When tilemode is set to "0". The new metaview (mview) viewports can be used. Mviews can be any size or place on the screen. They may overlap. More than one mview can be plotted at a time. Each mview can be quickly turned on or off.

1. **Type**

Command: TILEMODE

New value for tilemode <1> : 0

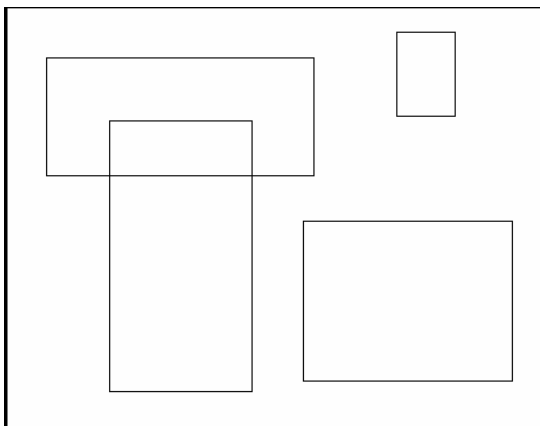

AutoCAD 2D Tutorial

Viewport Layers 29.12

VPLAYER (viewport layer) controls layers on and off, and freeze and thaw, for each mview. Layer controls the on and off, freeze and thaw, globally. Layers must be on and thawed globally before they can be effected per mview with vplayer.

1. **Click** in the viewport to change layer status.
2. **Choose** the layer dialog box.
3. **Highlight** the layer to freeze or thaw in the current or new viewport.

The layer dialog box also allows control of layers for each viewport.

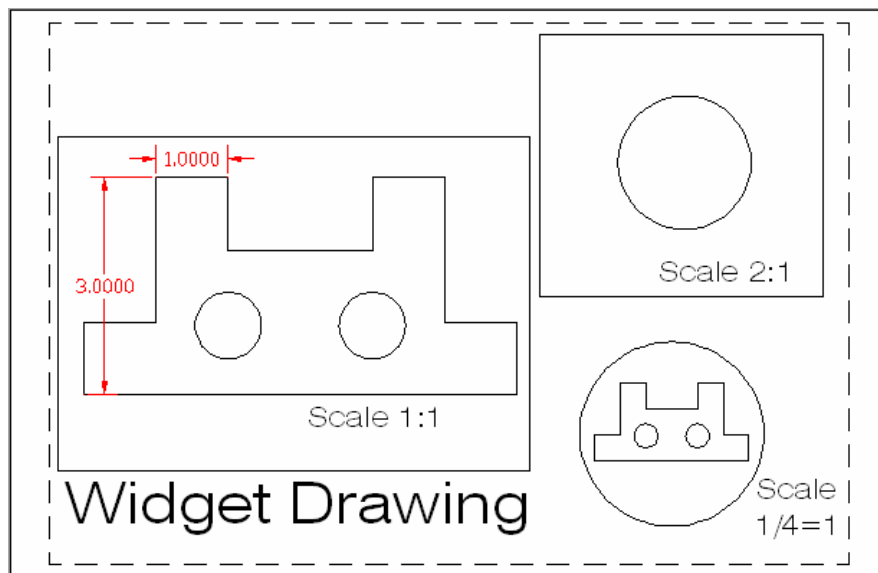
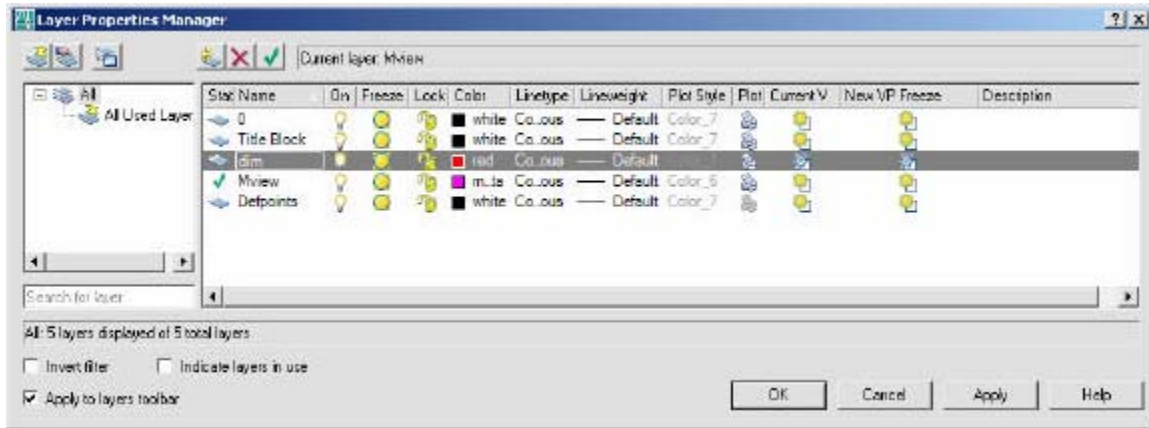

Chapter 30 Options Menu

AutoCAD 2D Tutorial

Files 30.1

1. **Choose** Tools, Options...
2. **Click** the Files TAB.

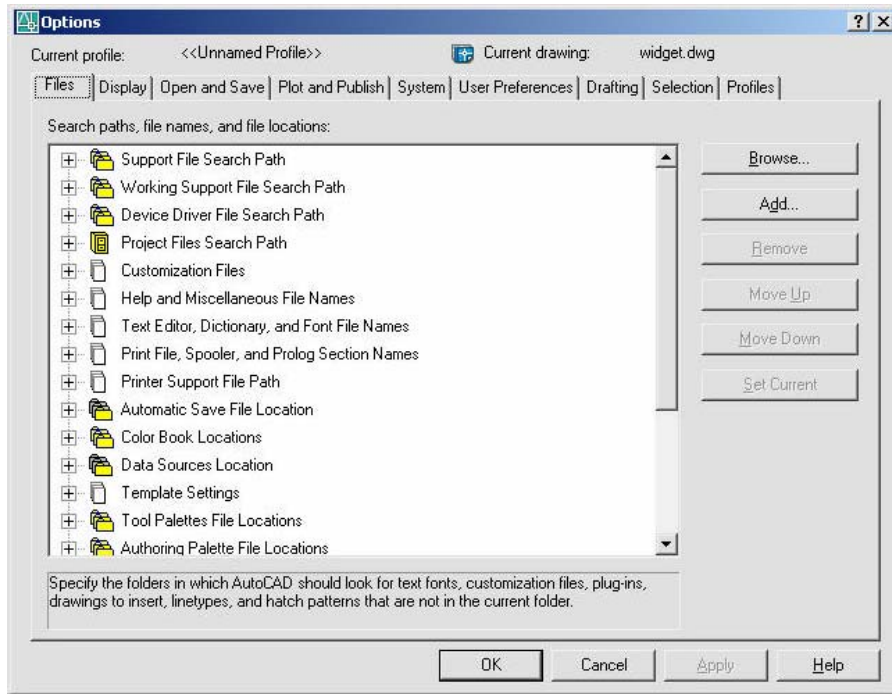

AutoCAD 2D Tutorial

Display 30.2

1. **Choose** Tools, Options...
2. **Click** the Display TAB.

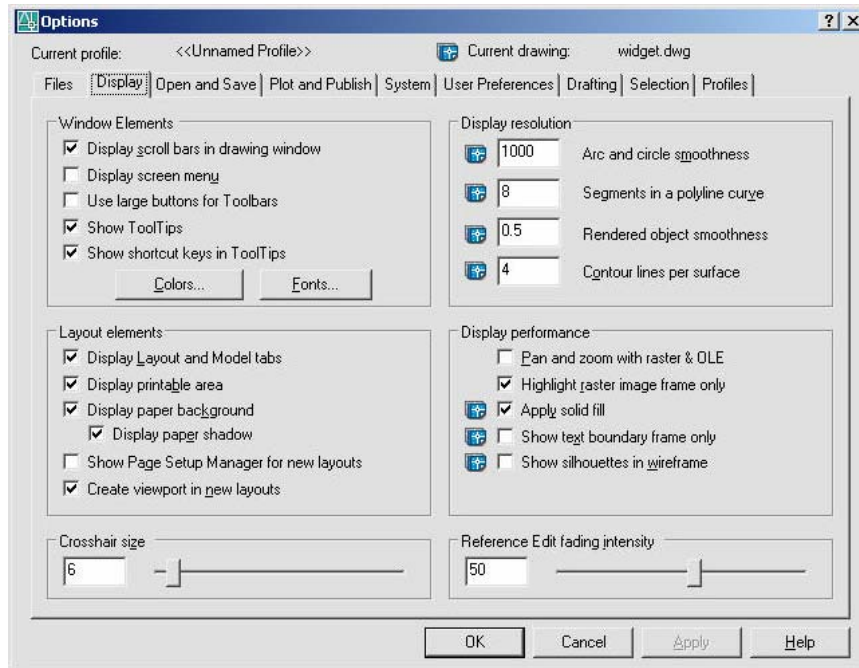

AutoCAD 2D Tutorial

Open and Save 30.3

1. **Choose** Tools, Options...
2. **Click** the Open and Save TAB.

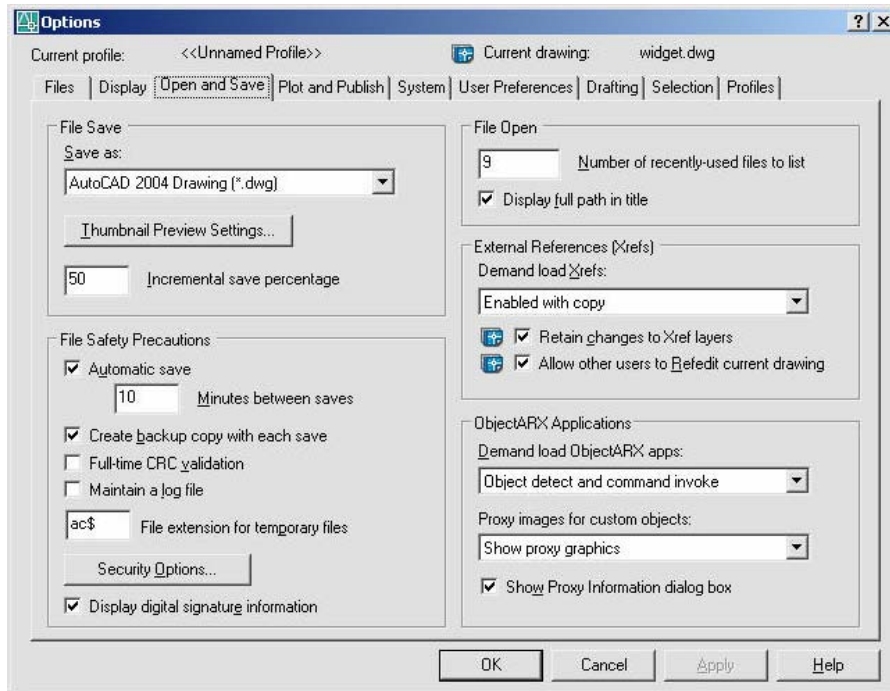

AutoCAD 2D Tutorial

Plotting 30.4

1. **Choose** Tools, Options...
2. **Click** the Plotting and Save TAB.

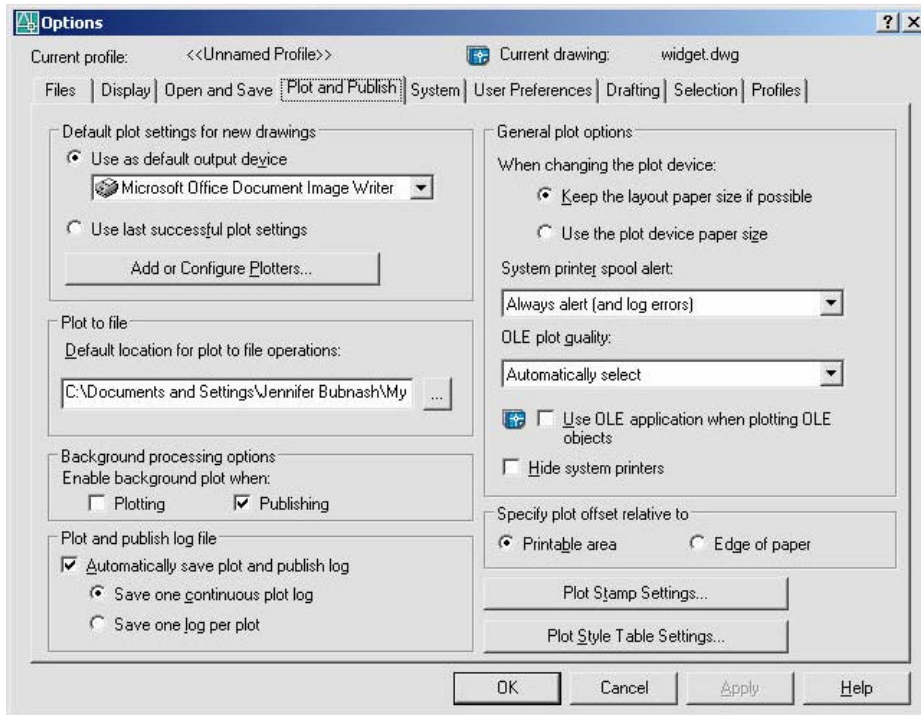

AutoCAD 2D Tutorial

System 30.5

1. **Choose** Tools, Options...
2. **Click** the System TAB.

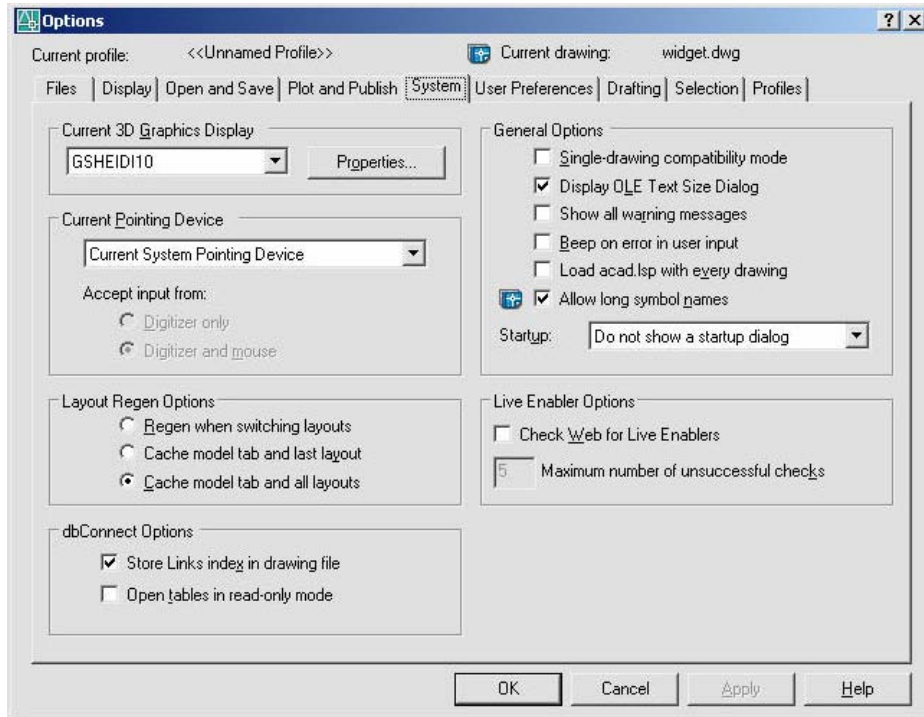

AutoCAD 2D Tutorial

User Preferences 30.6

1. **Choose** Tools, Options...
2. **Click** the User Preferences TAB.

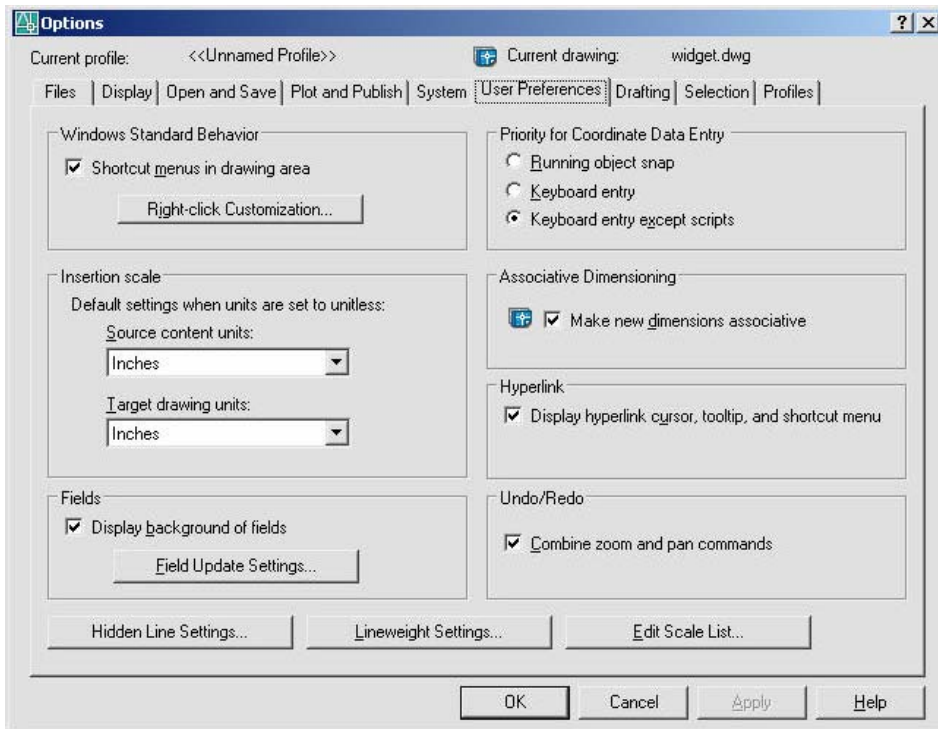

AutoCAD 2D Tutorial

Drafting 30.7

1. **Choose** Tools, Options...
2. **Click** the Drafting TAB.

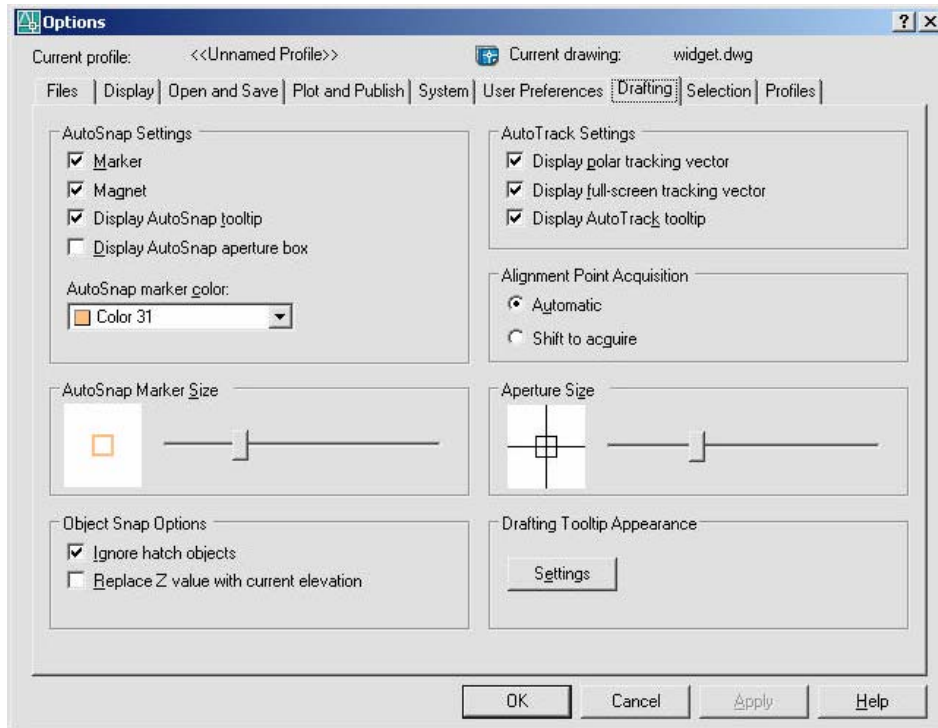

AutoCAD 2D Tutorial

Selection 30.8

1. **Choose** Tools, Options...
2. **Click** the Selection TAB.

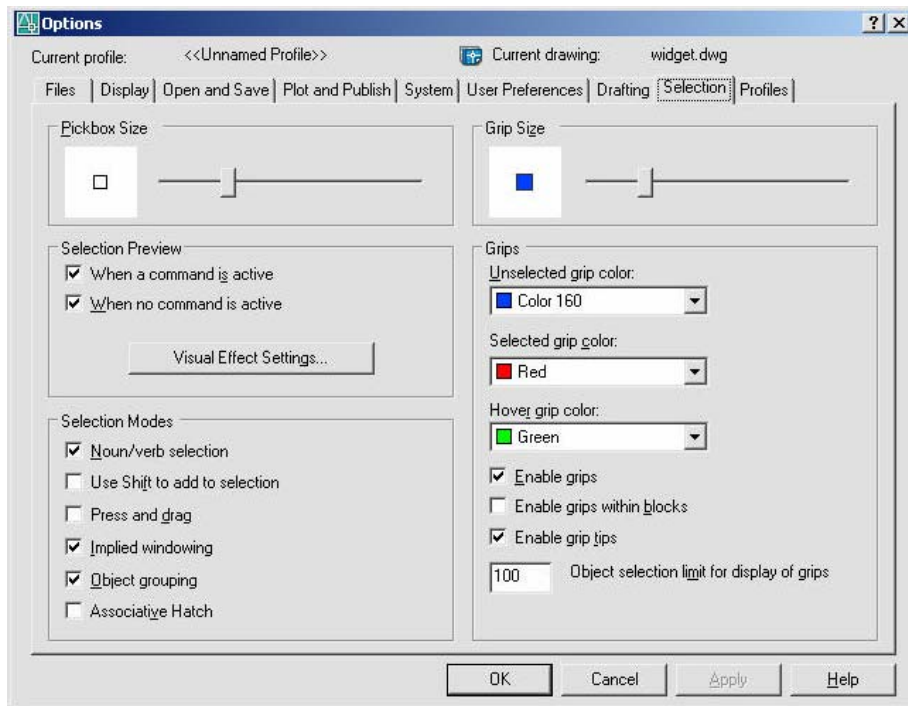

Chapter 31 Drawing Utilities

AutoCAD 2D Tutorial

AUDIT 31.1

1. **Choose** File, Drawing Utilities, Audit.
or
2. **Type** Audit at the command prompt
Command: **AUDIT**
3. **Type** Yes or No to fix any errors
Fix any errors detected? <N>: Y or N

If a drawing contains errors that AUDIT can't fix, use the RECOVER command to retrieve the drawing and correct its errors.

AutoCAD 2D Tutorial

RECOVER 31.2

1. **Choose** File, Drawing Utilities, Recover....
or
2. **Type** RECOVER at the command prompt
Command : **RECOVER**

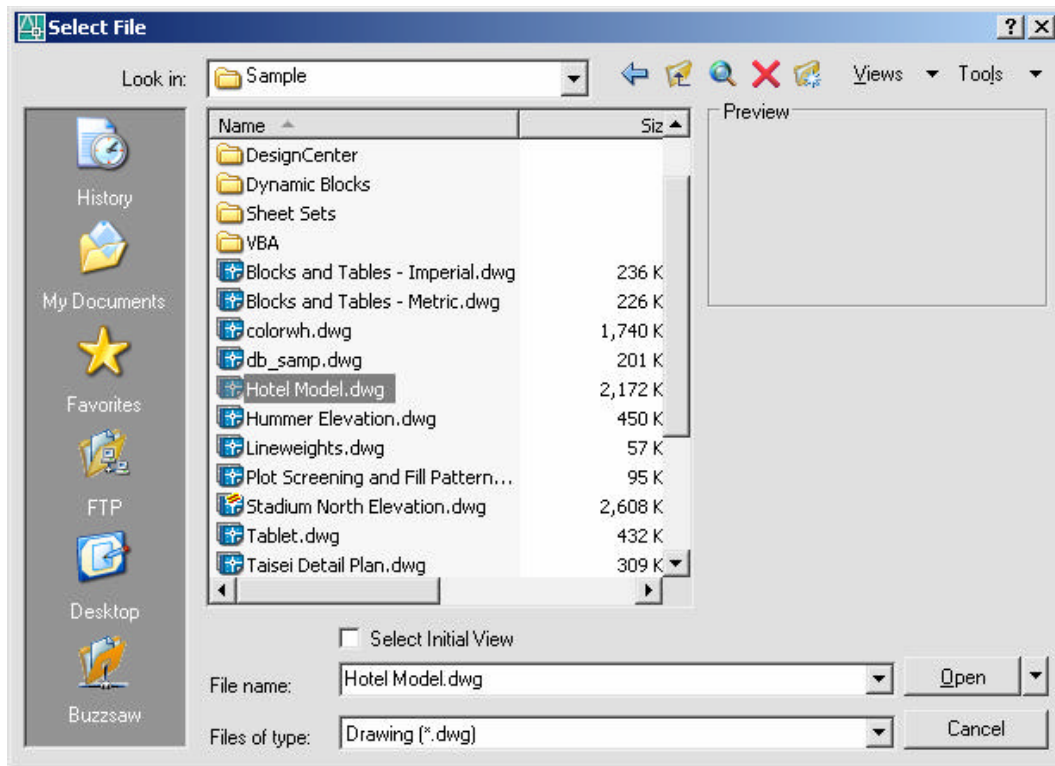

The RECOVER command performs recoveries or audit operations on DWG files only. Performing a recover on a DXF file will only open the file.

AutoCAD 2D Tutorial

PURGE 31.3

1. **Choose** File, Drawing Utilities, Purge.
or
2. **Type** PURGE at the command prompt
Command: **PURGE**
3. **Type** One of the following purge options:
Purge unused Blocks/Dimstyles/LAyers/LTypes/
SHapes/STyles/Mlinestyles/All:

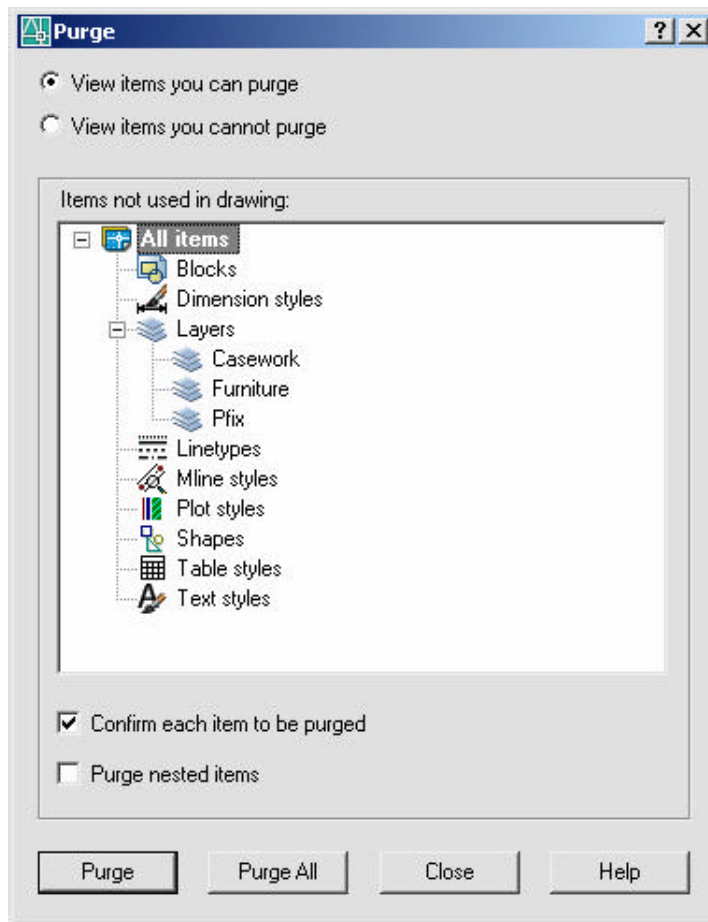

AutoCAD 2D Tutorial

Rename 31.4

1. **Choose** Format, Rename...
or
2. **Type** RENAME at the command prompt
Command: **RENAME**
3. **Choose** One of the following options to rename“ Block /
Dimstyle / LAYer / LType / Style / Ucs / Vlew / VPort:
4. **Type** The old object name
Old (object) name: **Enter the old name**
5. **Type** The new object name
New (object) name: **Enter the new name**

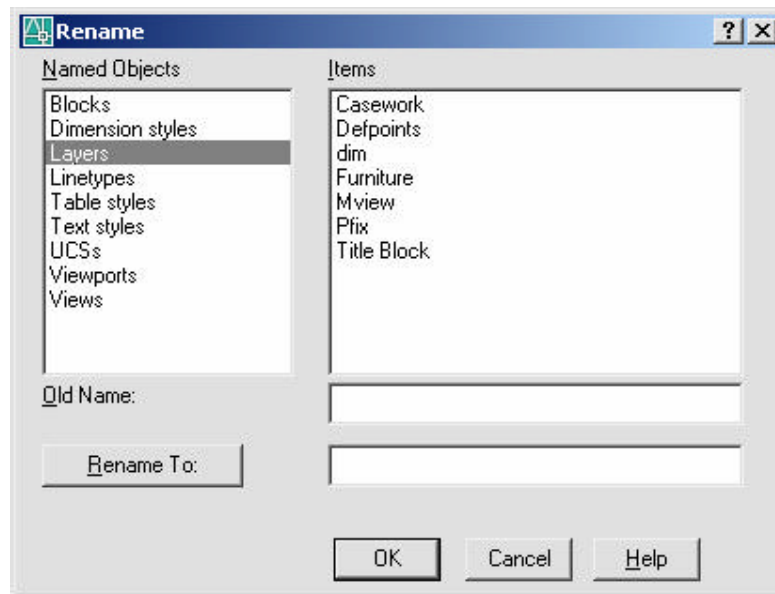

Chapter 32

Data Management

AutoCAD 2D Tutorial

Importing Files 32.1

1. **Choose** File, Open
or
2. **Choose** Insert, 3D Studio, ACIS, DXB, WMF, or ESP
or
3. **Type** Import at the command prompt.
Command: **Import**

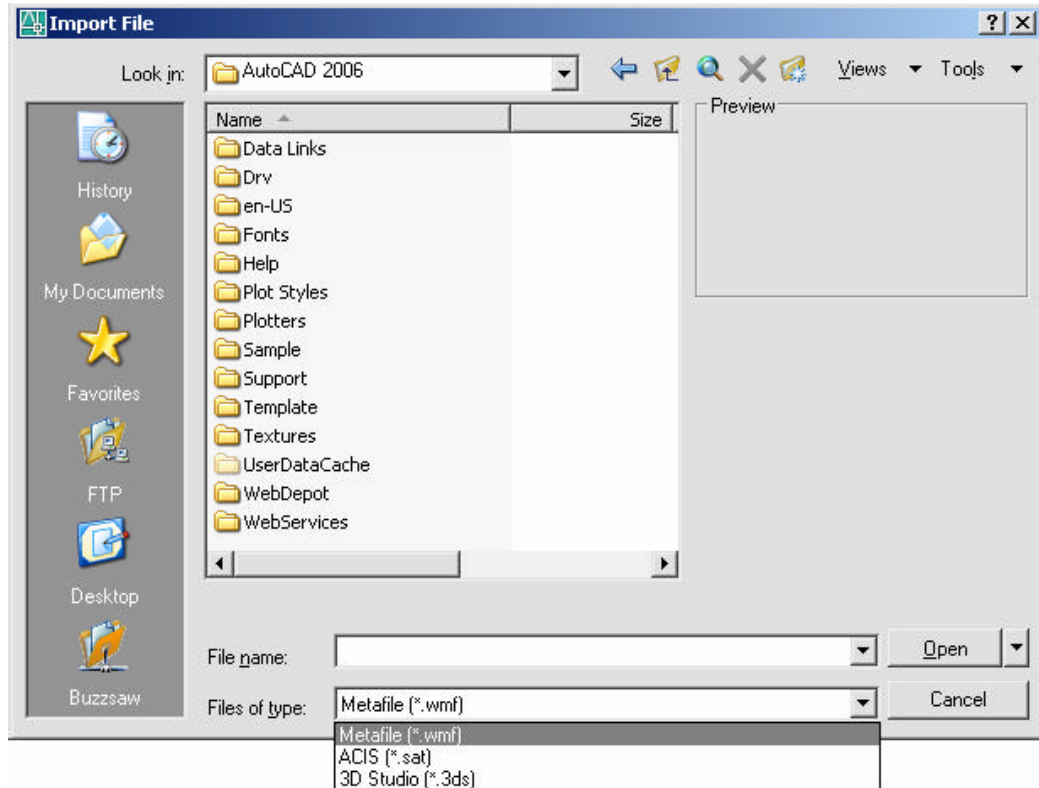

AutoCAD 2D Tutorial

Exporting Files 32.2

1. Choose File, Saveas
or
2. Choose File, Export

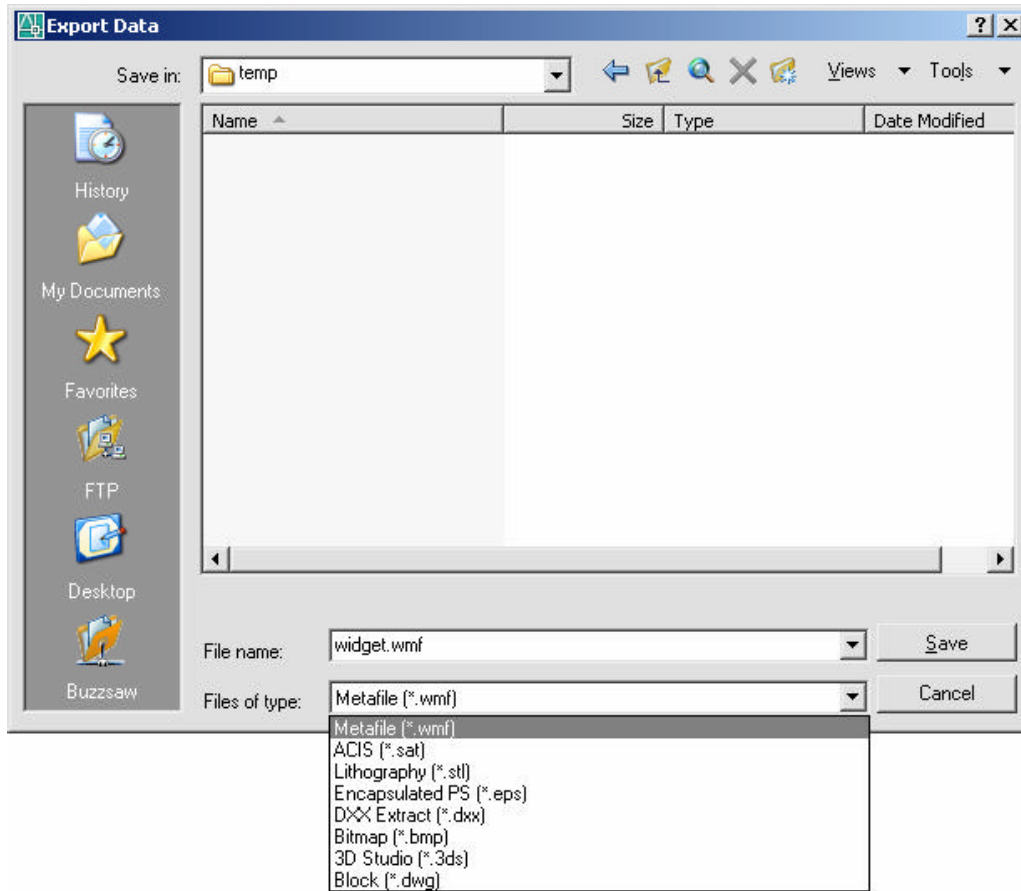

Chapter 33 **Object Linking and** **Embedding**

AutoCAD 2D Tutorial

Copying from AutoCAD 33.1

1. **Launch** a Windows program to link to (e.g. Microsoft Word)
2. **Open** an AutoCAD drawing.
3. **Choose** Edit, Copy.
4. **Pick** the AutoCAD objects to copy.
5. **TAB** to the Window's program.
6. **Choose** Edit, Paste.

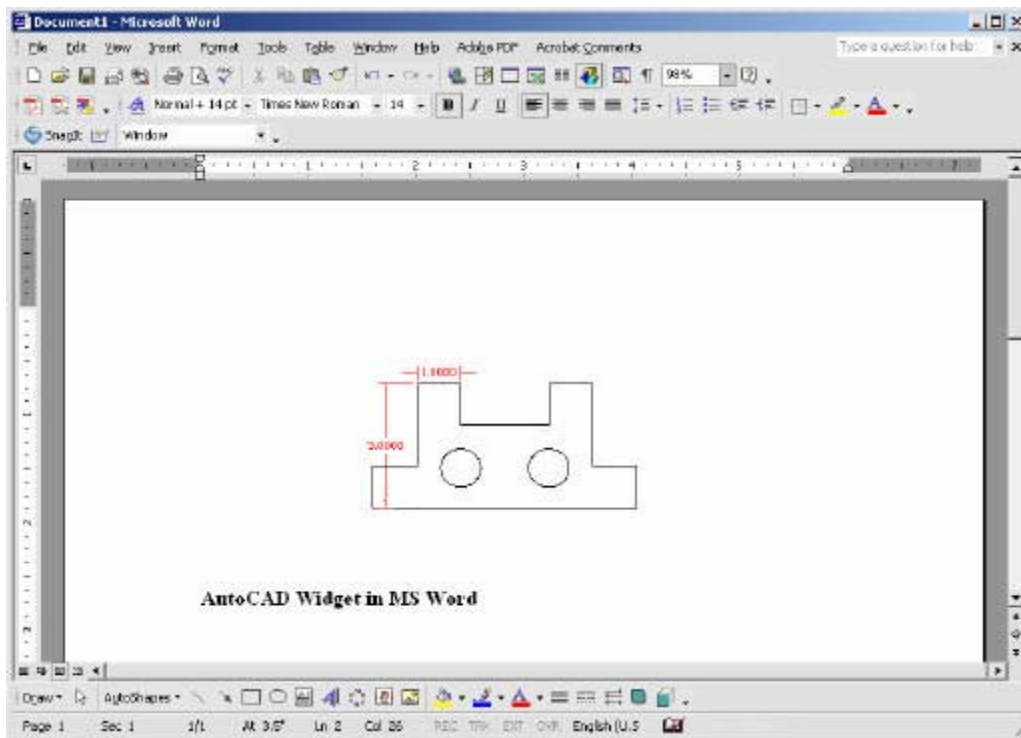

AutoCAD 2D Tutorial

Print Screen 33.2

1. **Launch** a Windows program to link to (e.g. Microsoft Word)
2. **Open** an AutoCAD drawing.
3. **Press** PRINT SCREEN on the keyboard.
4. **TAB** to the Window's program.
5. **Choose** Edit, Paste.

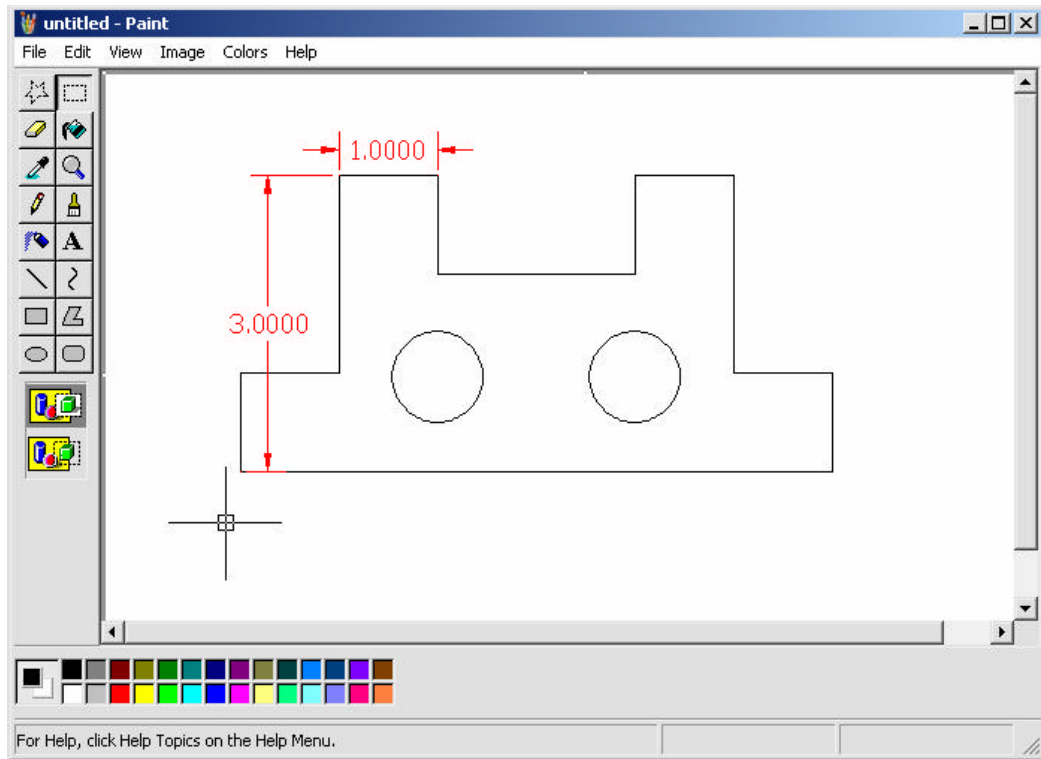

AutoCAD 2D Tutorial

OLE Linking to AutoCAD 33.3

A linked object remains associated with its source file. When you edit a linked object in AutoCAD, the source file changes. When you edit the object in the source file, the linked object in AutoCAD changes.

1. **Launch** a Windows program to link from (e.g. Microsoft Excel)
2. **Create** a spreadsheet to bring into AutoCAD.

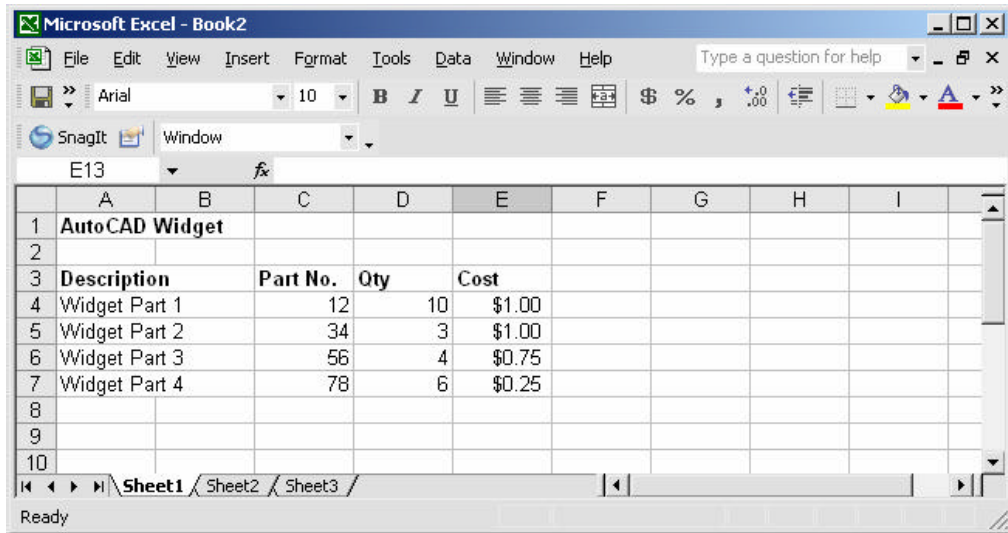

3. **Open** an AutoCAD drawing.
4. **Choose** Insert, OLE Object.
5. **Choose** browse to pick a file to link to AutoCAD.
6. **Pick** a location in the drawing to place the OLE object.

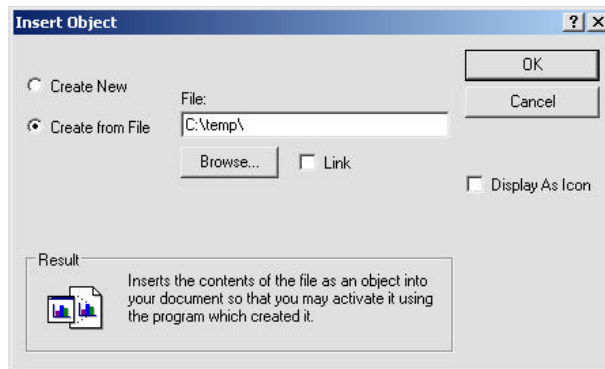

AutoCAD 2D Tutorial

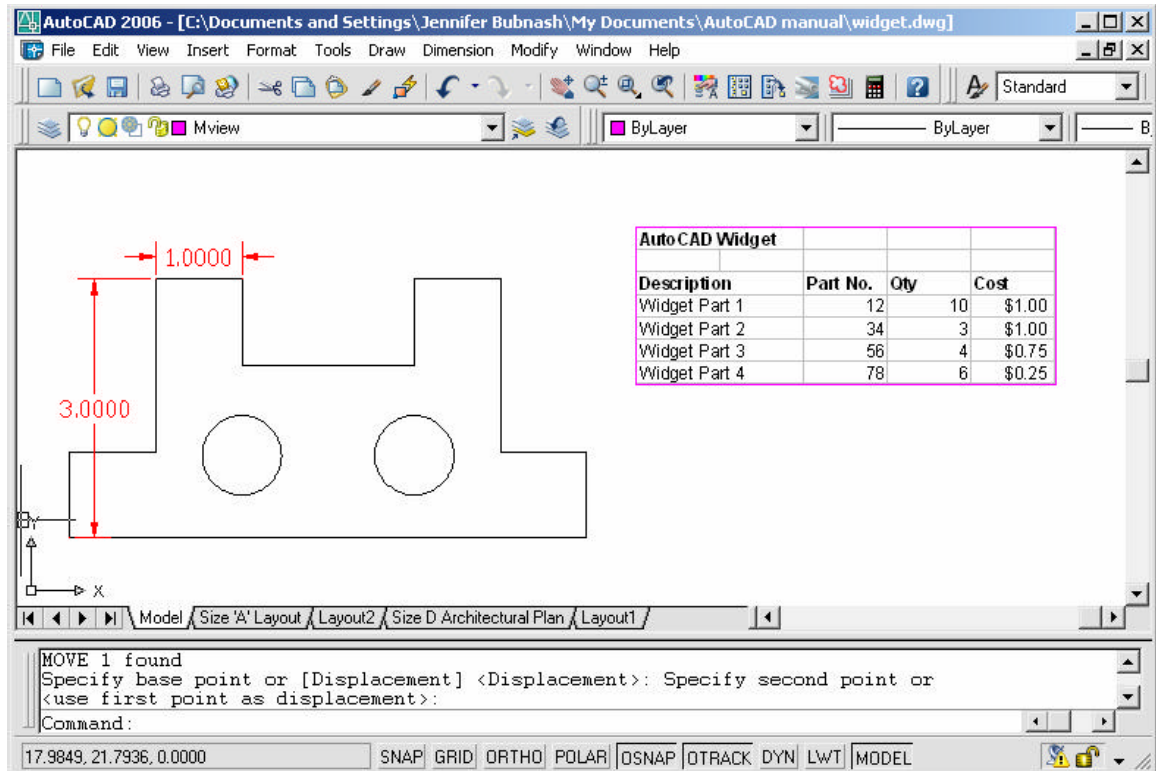

7. **Double Click** to edit that object in the original program.

TIPS:

- Spreadsheets that are imported into AutoCAD drawings with OLE are limited in size. If your spreadsheet is too large, you can reduce the column width and row height, reduce the font size, or paste the spreadsheet in separate parts to break the OLE object into smaller OLE objects.
- OLE objects are inserted in an AutoCAD drawing on the current layer. Turn off or freeze a layer to suppress the display of OLE objects on that layer.
- Set the system variable OLEHIDE to display or suppress the display of all OLE objects in paper space, model space, or both.

AutoCAD 2D Tutorial

Hyperlinking 33.4

1. **Choose** Insert, Hyperlink
or
2. **Press** CTRL + K
or
3. **Type** HYPE RLINK at the command prompt
Command: **hyperlink**
4. **Select** the object to hyperlink
Select objects: 1 found
5. **Choose** an option in the hyperlink dialog box.

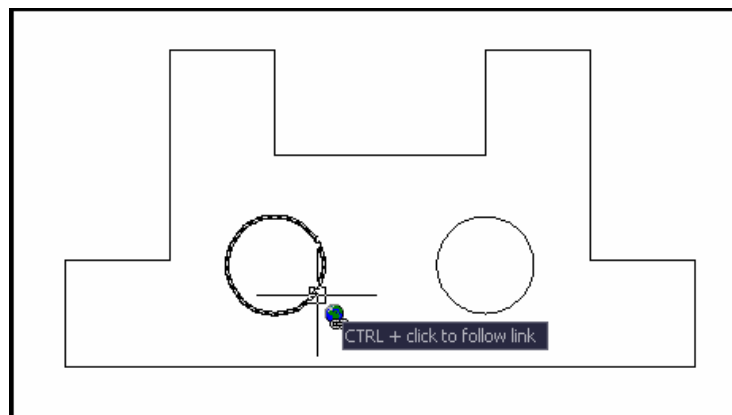
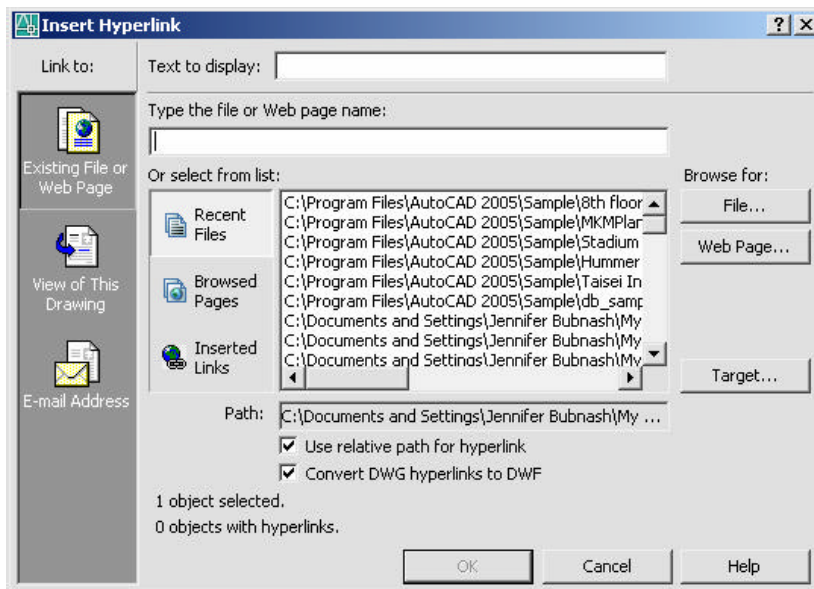

AutoCAD 2D Tutorial

Opening a Hyperlink 33.4

1. **Move** the cursor to the object with the hyperlink.
2. **Click** with your right mouse button.
3. **Choose** Hyperlink from the menu.
4. **Open** the file from the menu.

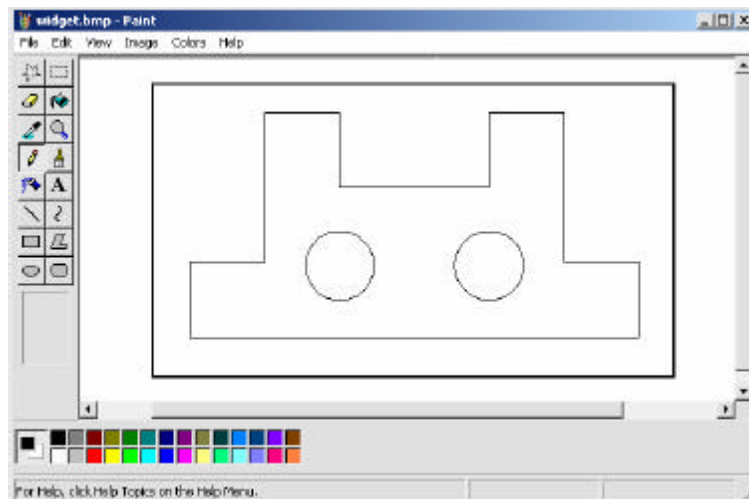
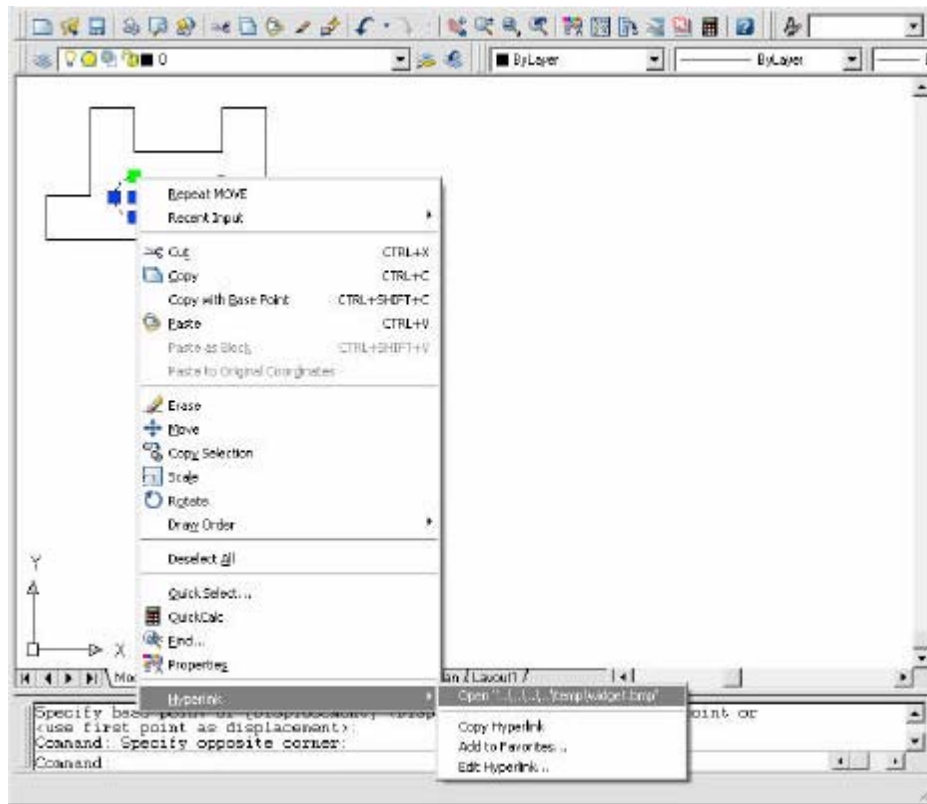

Chapter 34 Communication and Collaboration Tools

AutoCAD 2D Tutorial

34.1 Plotting to the WEB

1. **Type** **PLOT** at the command prompt.
Command: **plot**
2. **Choose** the Plot Device TAB.
3. **Choose** the dropdown list for Plotter Configuration.
4. **Plot** to a .DWF, JPG, or PNG file.

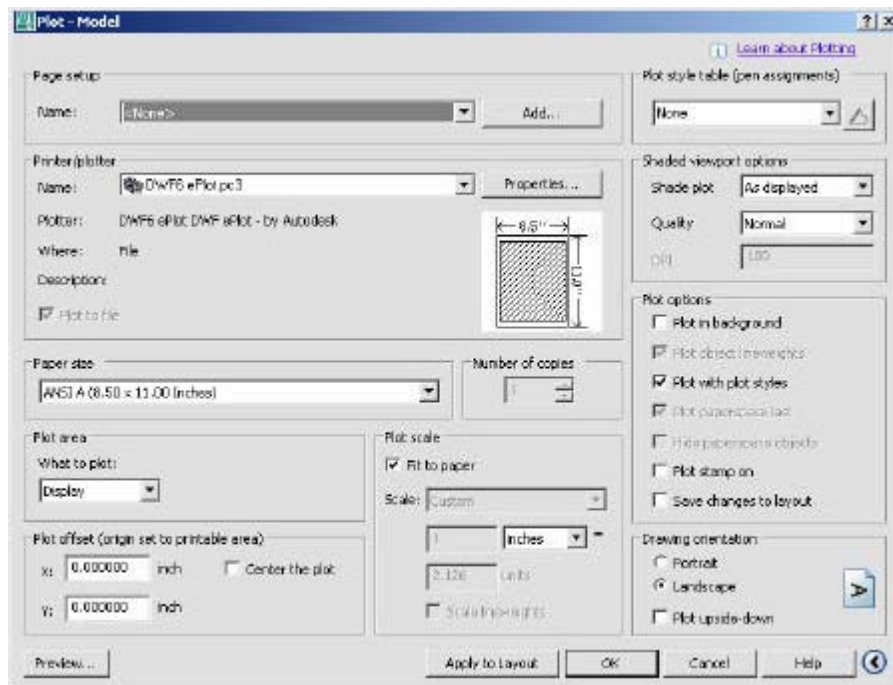

- DWF format does not compress the drawing file.
- JPEG format uses lossy compression; that is, some data is deliberately discarded to greatly reduce the size of the compressed file.
- PNG (Portable Network Graphics) format uses lossless compression; that is, no original data is sacrificed to reduce the size of the file.

AutoCAD 2D Tutorial

34.2 Configuring DWF Files

1. **Type** PLOT at the command prompt.
Command: **plot**
2. **Choose** the DWF plot configuration option.
3. **Choose** the **Properties...** button.
4. **Choose** **Custom Properties....**
5. **Slide** the slider bar to extreme for a clearer resolution on the DWF file.

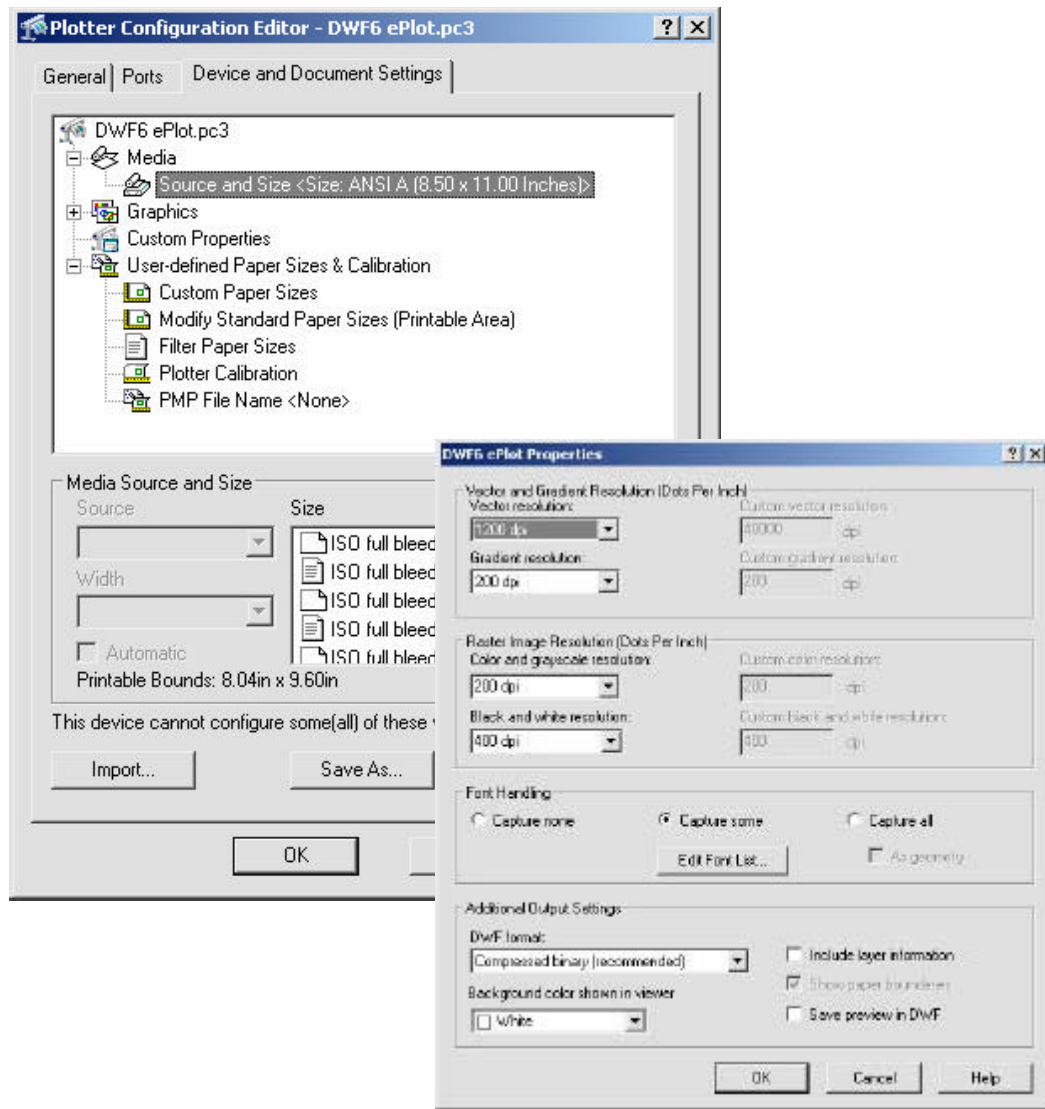

AutoCAD 2D Tutorial

34.3 Publish Command

1. **Choose** the Publish to WEB icon from the Standard Toolbar. 

or

2. **Choose** File, Publish
3. **Type** PUBLISH at the command prompt.

Command: **publish**

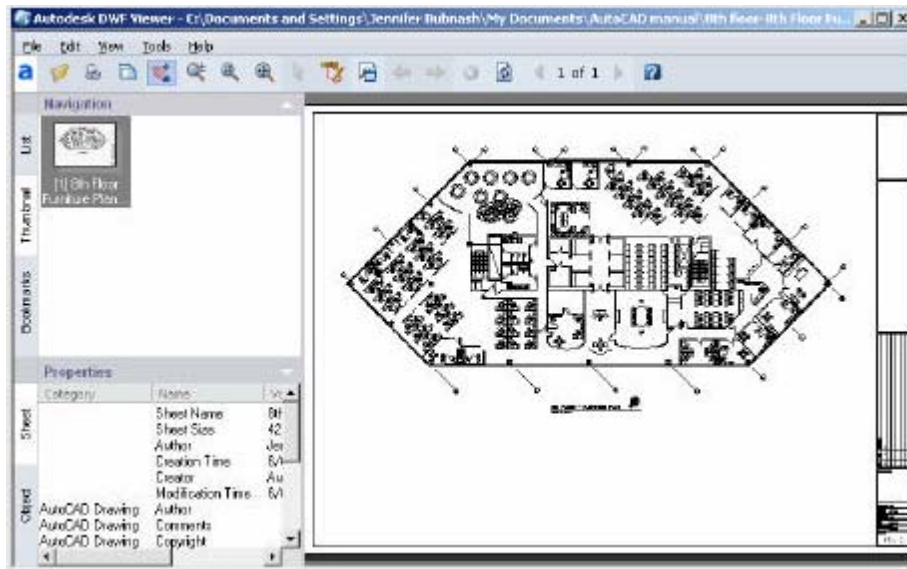
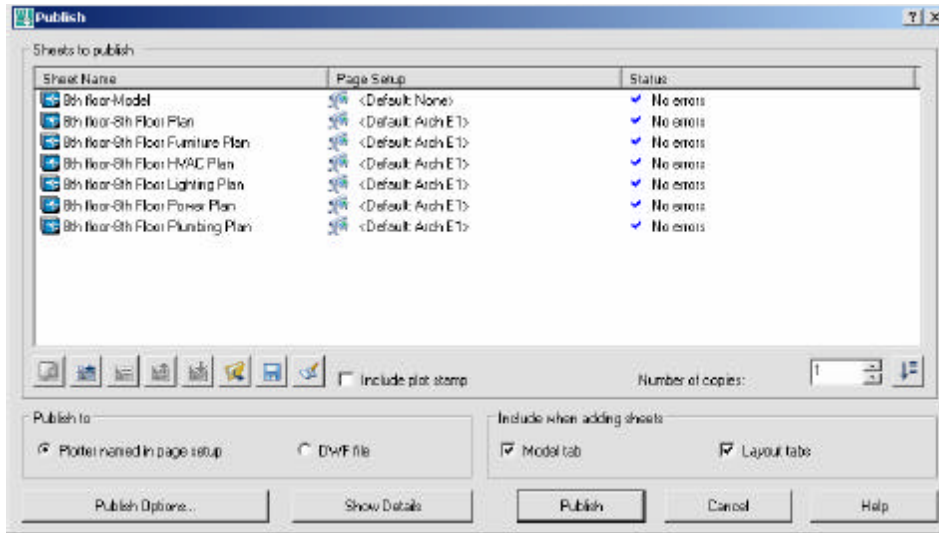

AutoCAD 2D Tutorial

34.4 Publishing WEB Pages

1. **Choose** File, Publish to WEB.
or
2. **Type** PUBLISHTOWEB at the command prompt.
Command: **PUBLISHTOWEB**
3. **Click** Create New Web Page and Next.

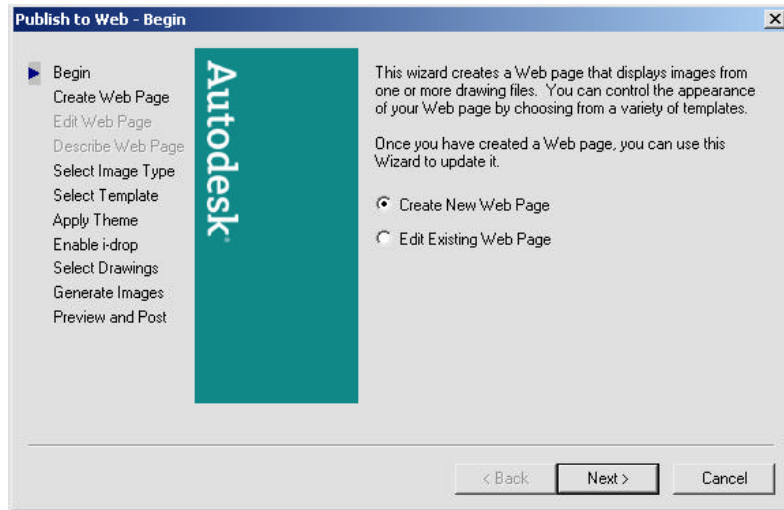

4. **Specify** a name for the WEB page, location and description for the new WEB page and click Next.
(NOTE: Save the WEB pages to C:\TEMP)

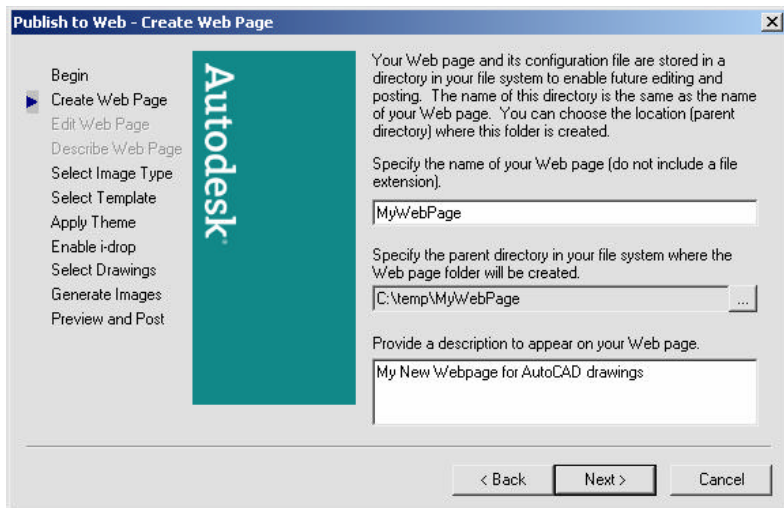

AutoCAD 2D Tutorial

4. **Select** PNG as the image type for the drawings and Image Size “Medium” and click Next.

NOTE: If you have the Express Viewer loaded, you can pick DWF files to view. This will allow you to zoom and pan the drawings.

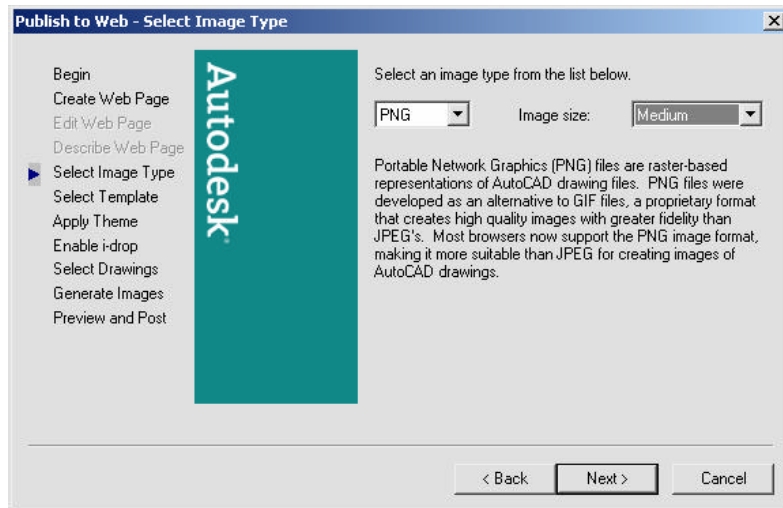

5. **Select** Array of ThumbNails as the Template type and click Next.

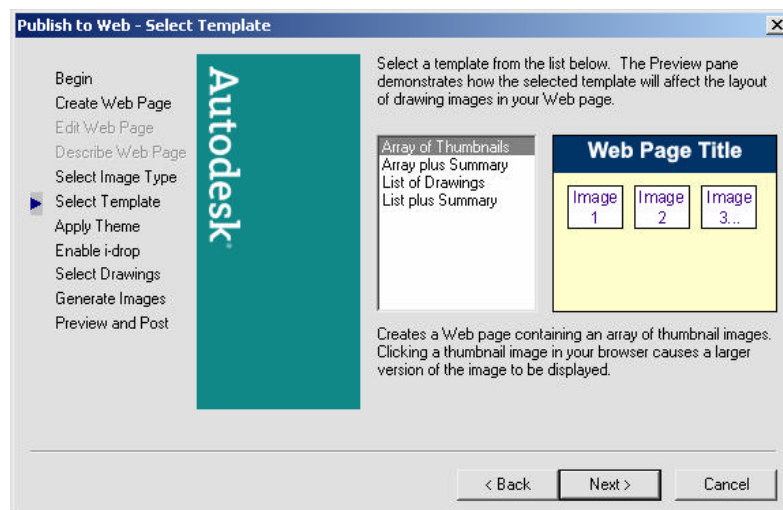

AutoCAD 2D Tutorial

6. **Select** a Theme (color) and click Next.

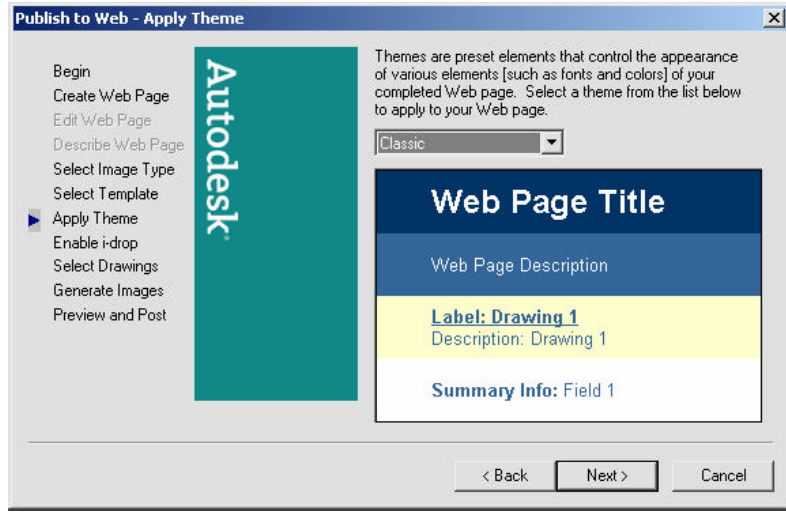

7. **Select** Enable i-drop and Click Next

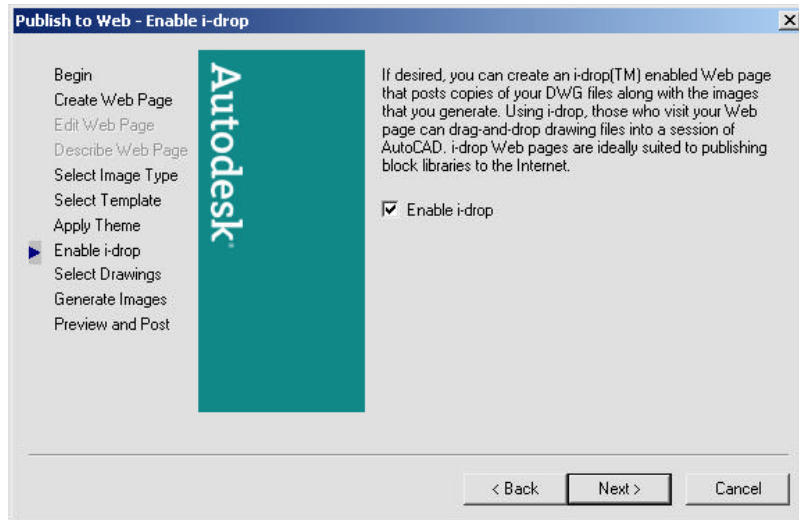

AutoCAD 2D Tutorial

8. **Select** drawings and/or layouts to place on the WEB page.

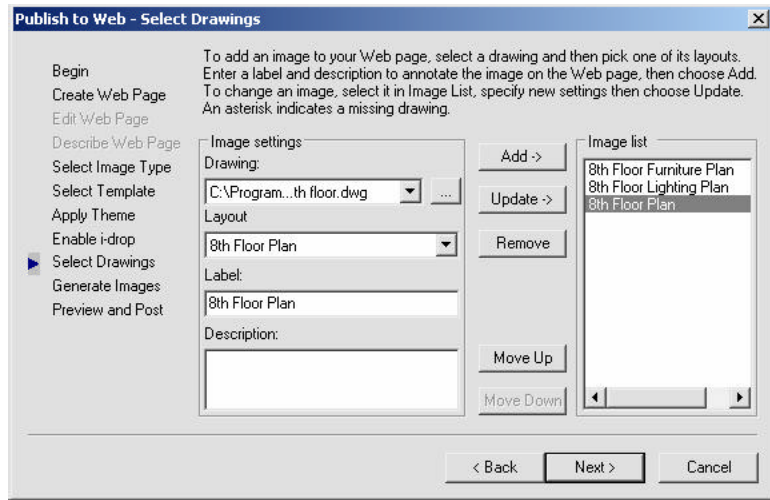

9. **Click** Regenerate all images and Next.

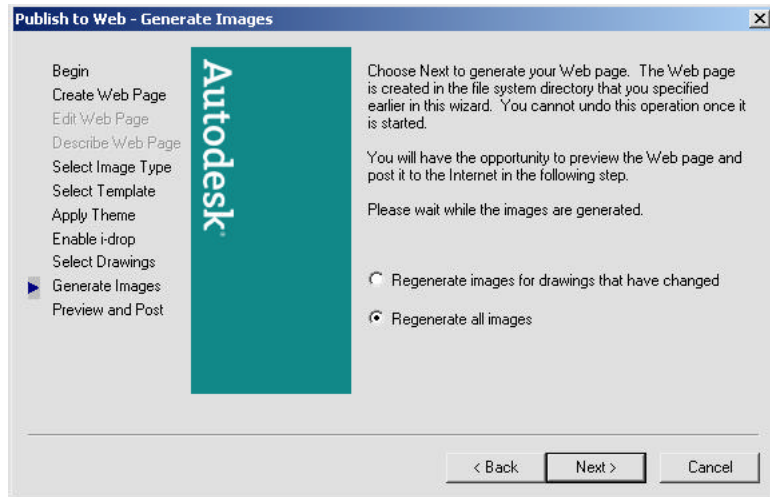

AutoCAD 2D Tutorial

10. **Click** Preview and Finish.

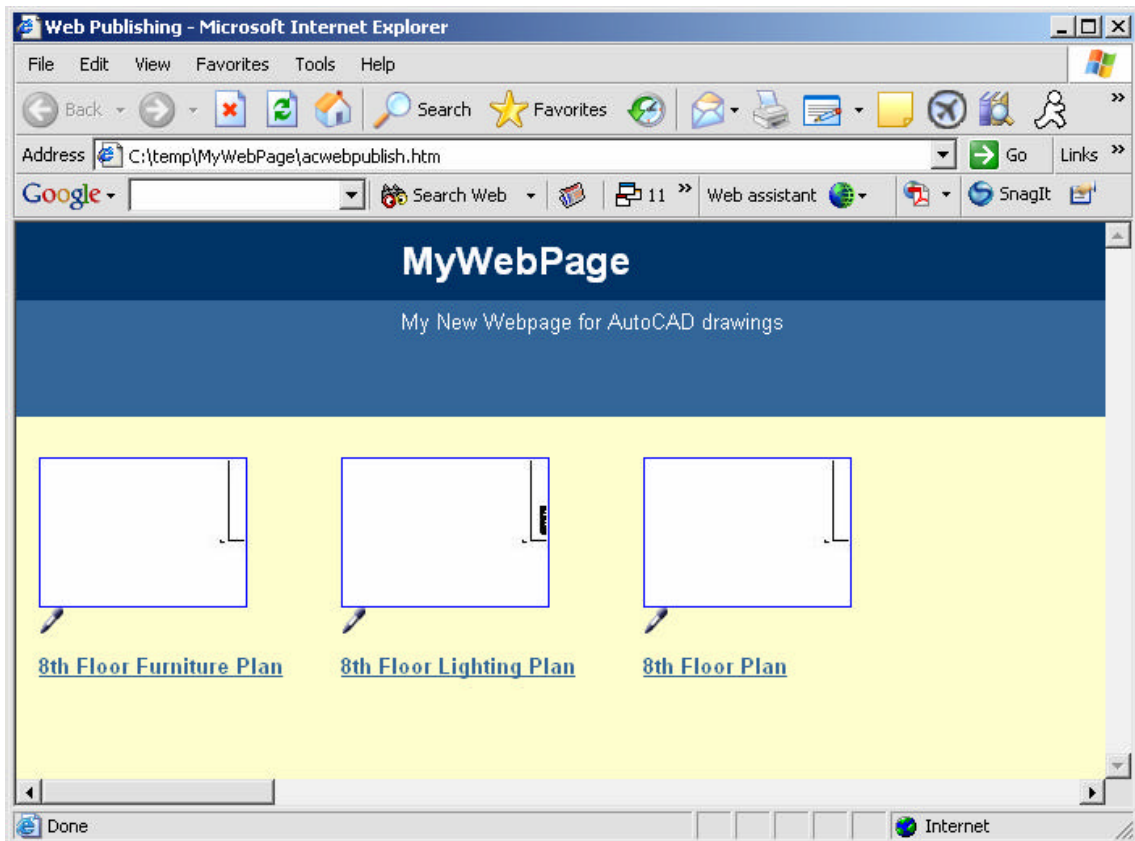
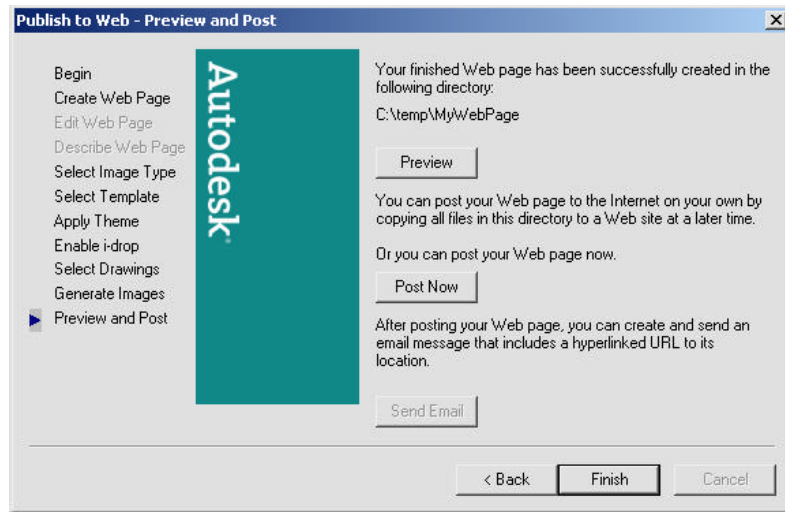

AutoCAD 2D Tutorial

34.4 e-Transmit

1. **Type** **ETRANSIT** at the command prompt.
Command:**etransmit**

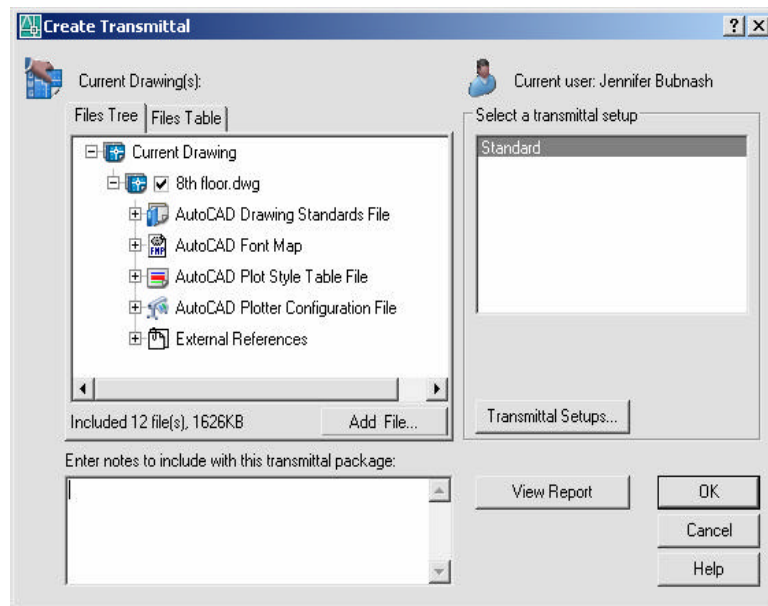

e-Transmit options

.EXE (files are self extracting)

.ZIP (PKZIP or WINZIP is needed to extract files)

AutoCAD 2D Tutorial

34.6 i-Drop

i-drop allows users to drag a drawing from an i-drop handle on an i-drop supported WEB site to an open AutoCAD drawing. Choose the i-drop option when publishing to the WEB to create an i-drop enabled WEB page.

1. **Type** <http://www.autodesk.com/idrop> to learn more about Autodesk's i-drop technology.

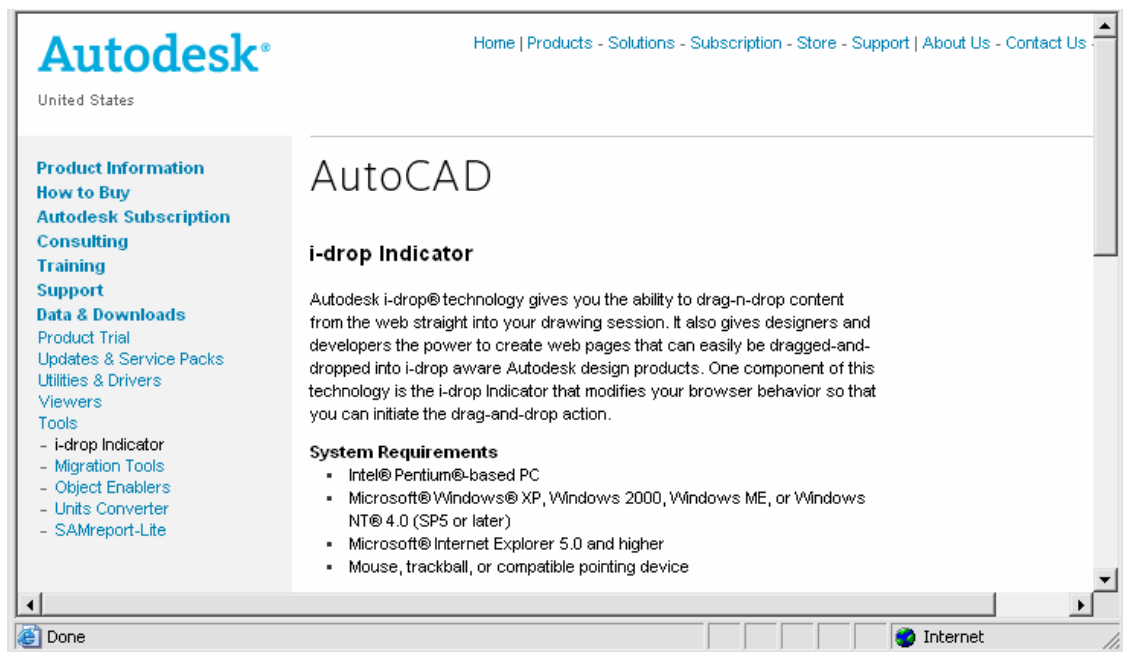

Chapter 35

AutoCAD WEB Viewers

AutoCAD 2D Tutorial

AutoCAD DWF Viewer 35.1

1. **Launch** Your WEB Browser.
2. **Type** <http://www.autodesk.com/products>
3. **Click** on Autodesk DWF View from the list of Autodesk products.
4. **Browse** the site for information or to download a free copy of the DWF Viewer.



AutoCAD 2D Tutorial

Volo View 35.2

1. **Launch** Your WEB Browser.
2. **Go to** <http://www.autodesk.com/products/>
3. **Click** Volo View to learn more about the Volo View application.

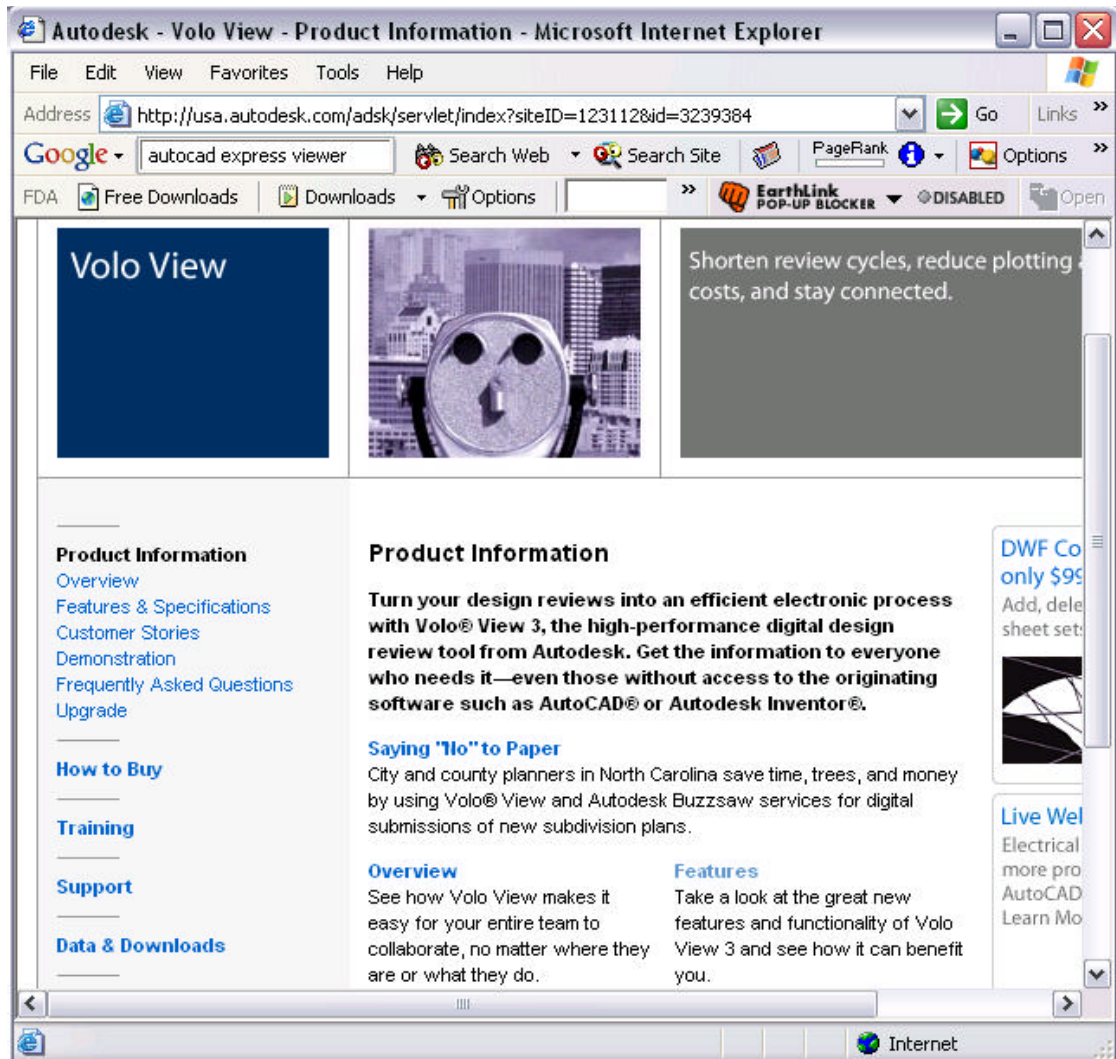

AutoCAD 2D Tutorial

CAD Viewer 35.3

1. **Launch** Your WEB Browser.
2. **Go to** <http://www.cadviewer.com/>

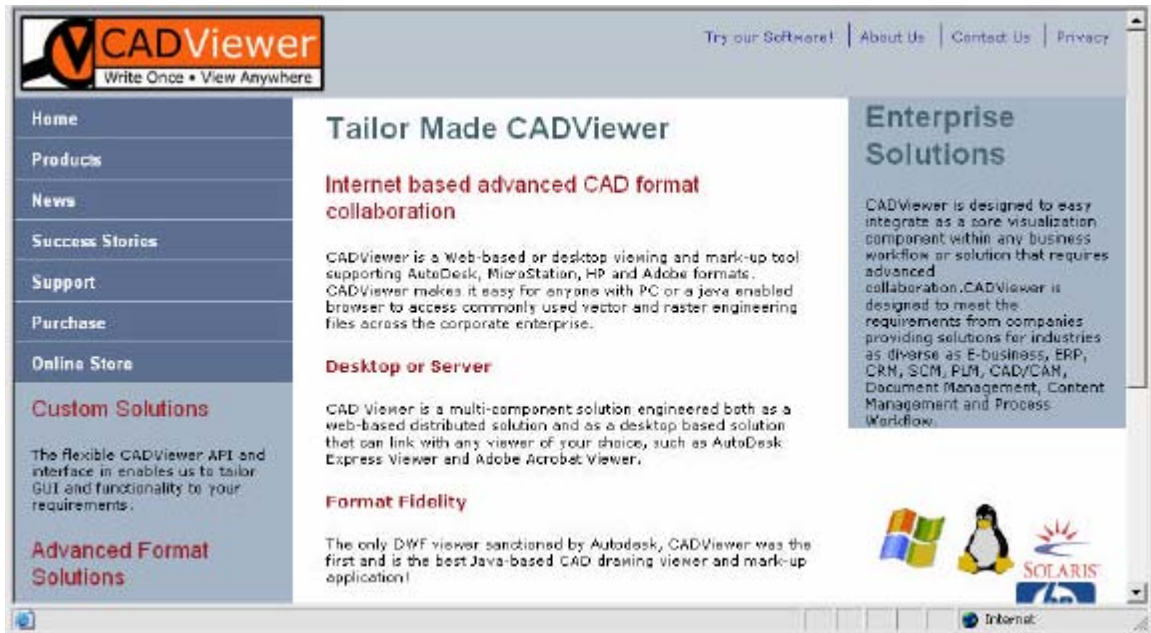

AutoCAD 2D Tutorial

Internet Explorer 35.5

1. **Launch** Internet Explorer 5.0 or later.
2. **Choose** File, Open.
3. **Browse** to C:\TEMP and open a .DWF file to view.

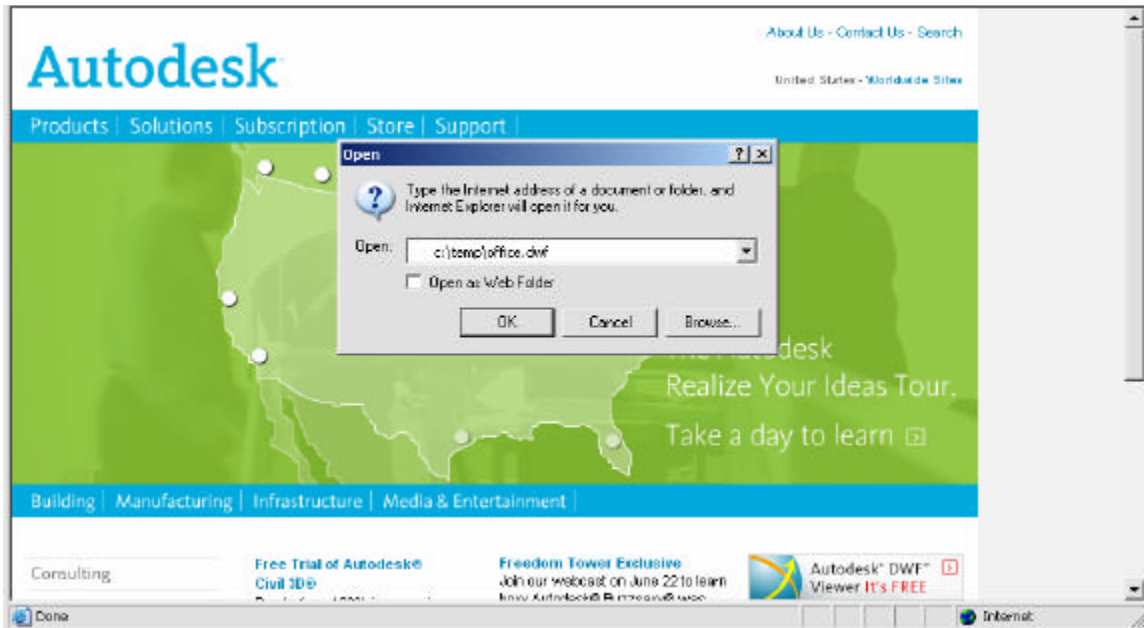

AutoCAD 2D Tutorial

AutoCAD Related WEB Sites 35.6

1. **Launch** Internet Explorer.
2. **Click** on one of the following WEB sites.
or
3. **Search** for AutoCAD related topics on the Internet on an Internet search engine

<http://www.cadalog.com>

<http://www.cadalyst.com/>

<http://www.cadsoftware.com/>

<http://www.3dcafe.com/>

<http://www.mcneel.com>

<http://www.caddepot.com/>

<http://www.caddigest.com/>

Chapter 36 Customization

AutoCAD 2D Tutorial

Menu Loading 36.1

1. **Type** MENU at the command prompt.
Command: **Menu**
2. **Choose** a menu (mnu) file to load.

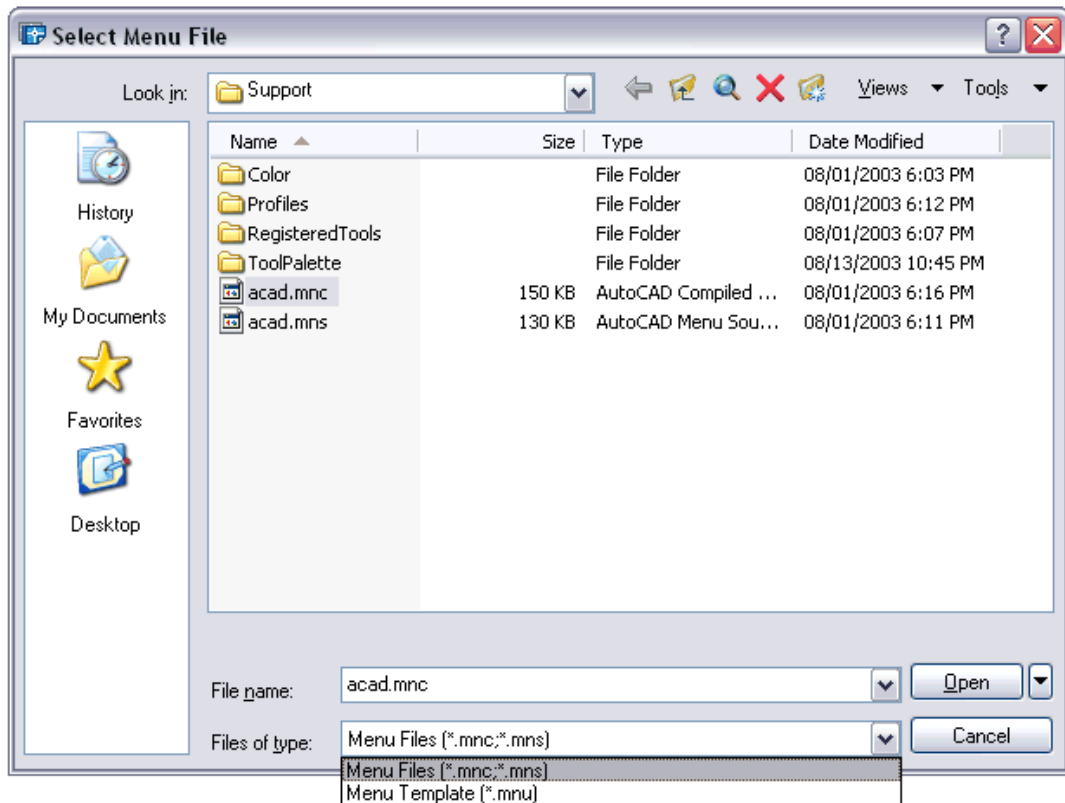

AutoCAD 2D Tutorial

Creating New Menu Files 36.2

1. **Copy** ACAD.MNU to a new file name such as **MYACAD.mnu**
2. **Type** MENU at the command prompt to load the new menu.

Command: MENU

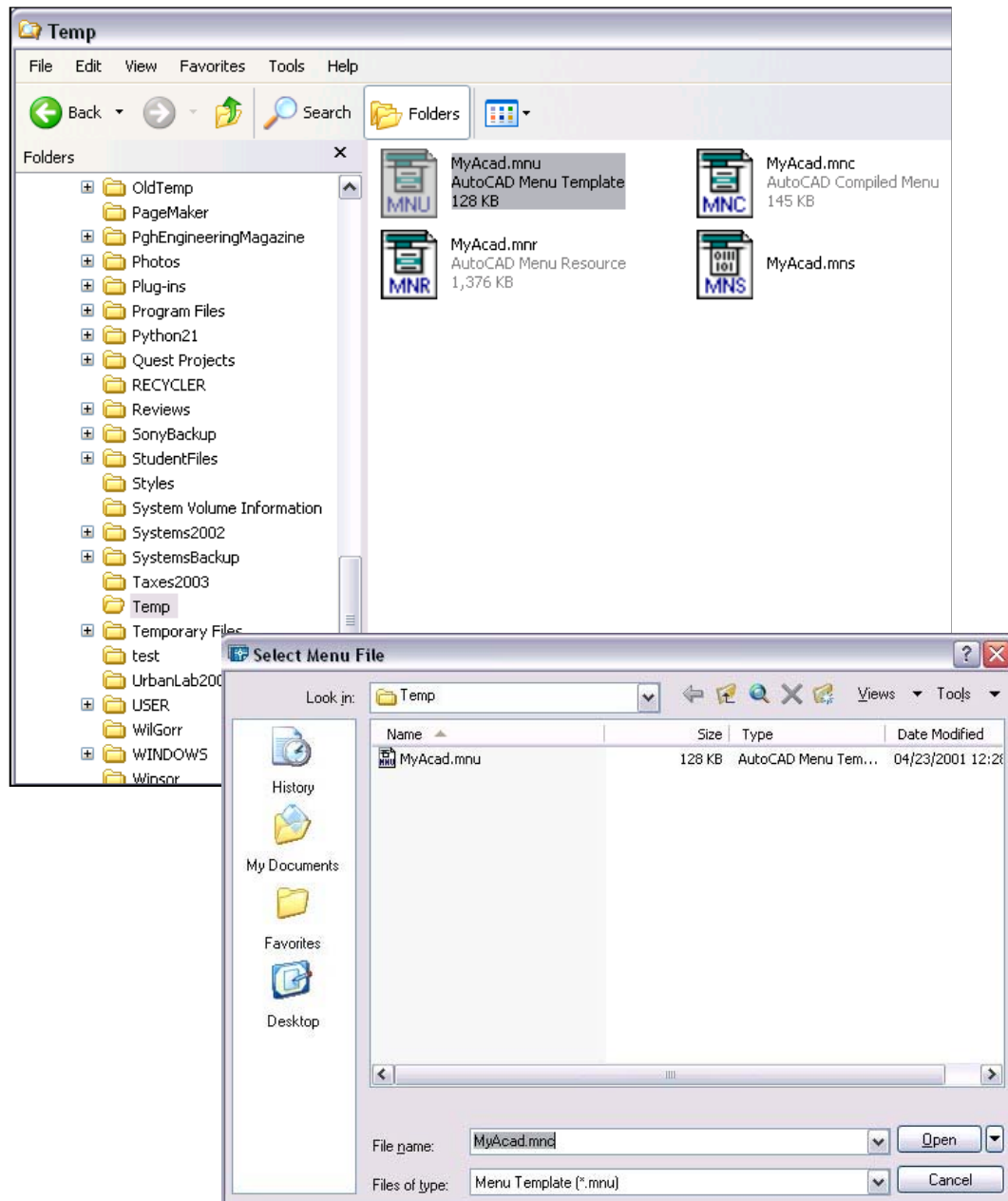

AutoCAD 2D Tutorial

Menuload 36.3

1. **Choose** Tools, Customize, Menus...
or
2. **Type** MENULOAD at the command prompt.
Command: **MENULOAD**
3. **Choose** the Menu Bar Tab.
4. **Choose** Add or Remove to modify the appearance of the Pulldown menu.

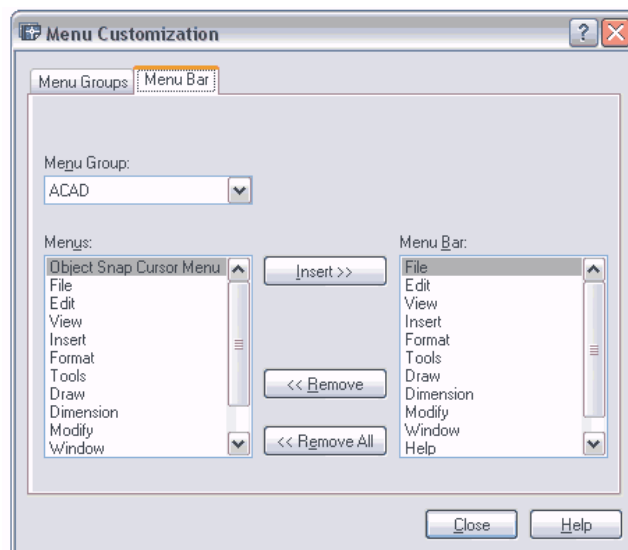
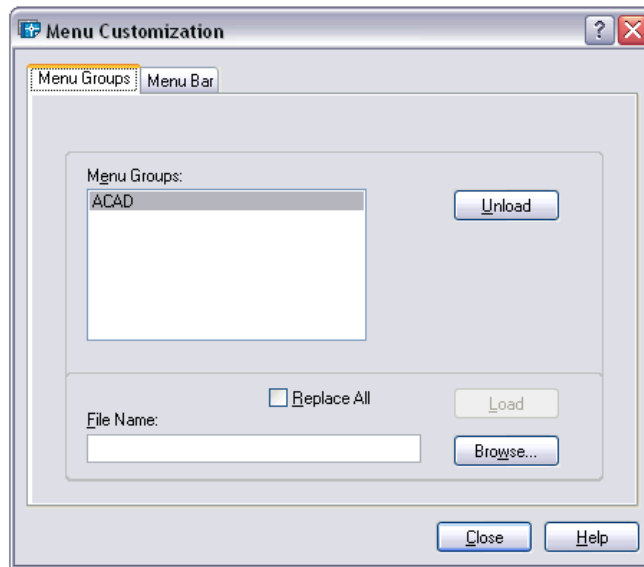

AutoCAD 2D Tutorial

Customizing Toolbars 36.4

Create New Toolbars

1. **Choose** View, Toolbars... or
2. **Type** TBCONFIG or TOOLBAR at the command prompt.
Command: **TBCONFIG** or **TOOLBAR**

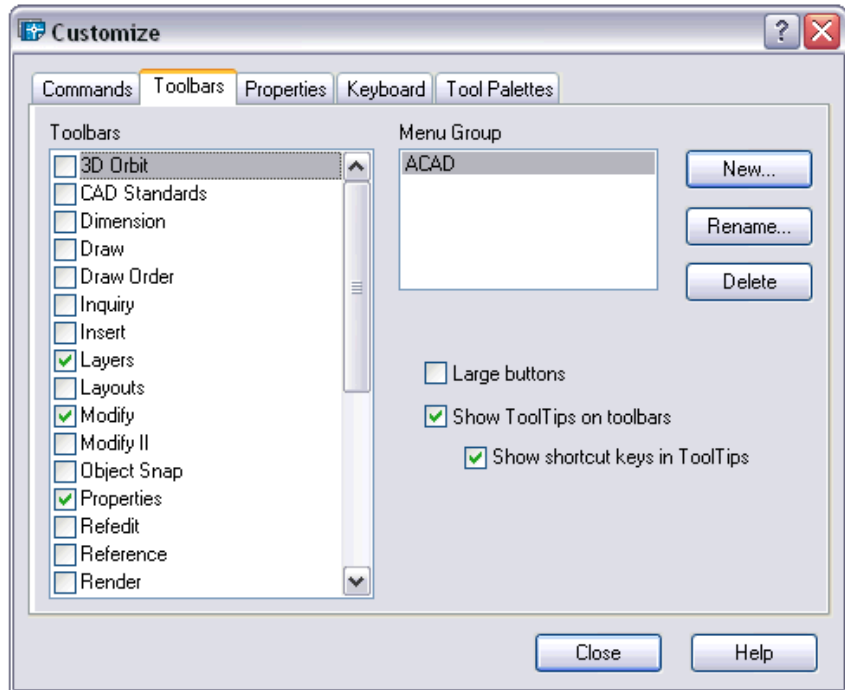

3. **Choose** the **New...** button.
4. **Type** the name of the new toolbar.
5. **Click** OK.



AutoCAD 2D Tutorial

6. Choose the Commands...TAB.

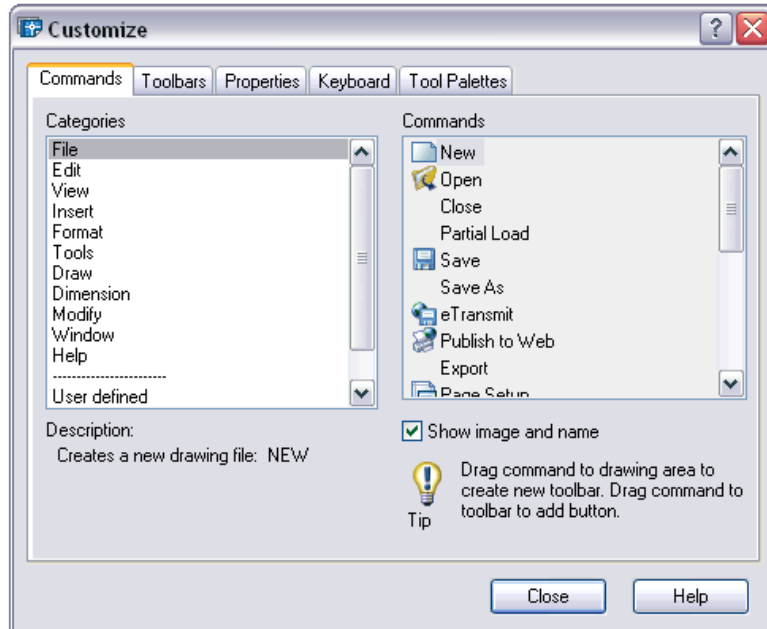

7. **Drag** commands from each menu and drop onto your toolbar.

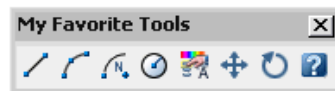

TIP: To copy a tool from another toolbar, press and drag the tool to the new toolbar.

8. **Choose** Close to close the Customize dialog box.

AutoCAD 2D Tutorial

User Defined Buttons 36.5

1. **Choose** View, Toolbars...
2. **Choose** the Commands...TAB.
3. **Click** **User Defined** from the Categories section.

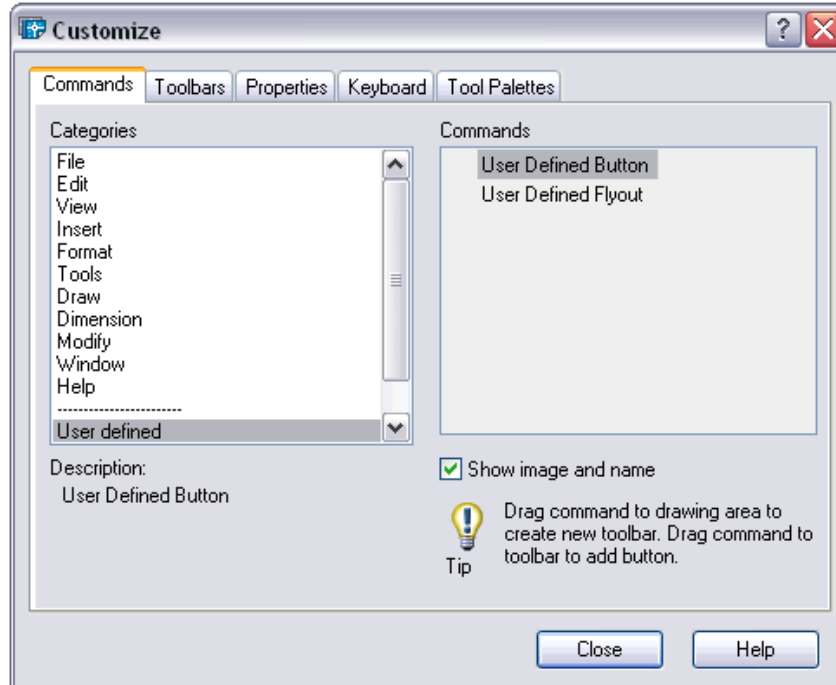

4. **Drag** a user defined button to your toolbox.

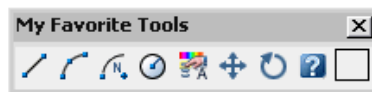

5. **Double Click** the new button.
The Button Properties dialog box will appear.
6. **Choose** Edit...from the Button Properties window.

AutoCAD 2D Tutorial

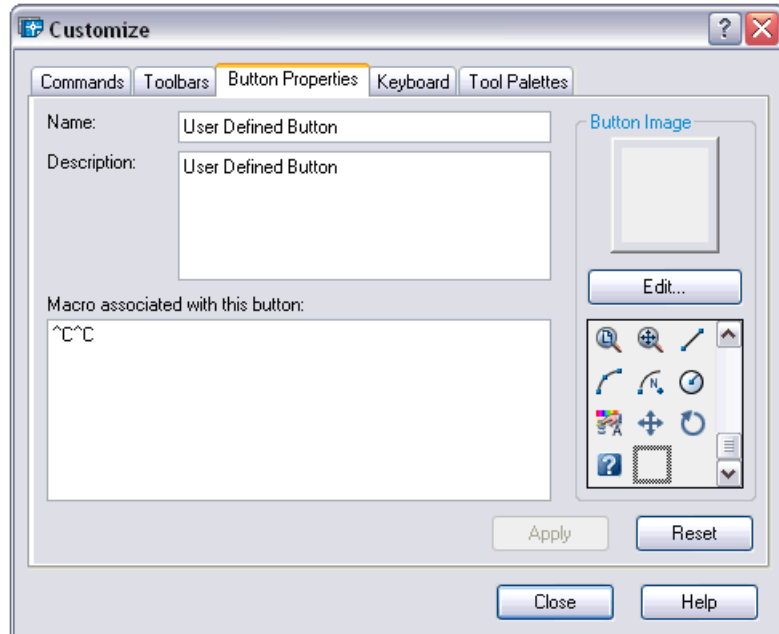

7. **Draw** the desired symbol by using the draw tools.
8. **Close** the Button Editor (save if necessary).
9. **Press** Apply.

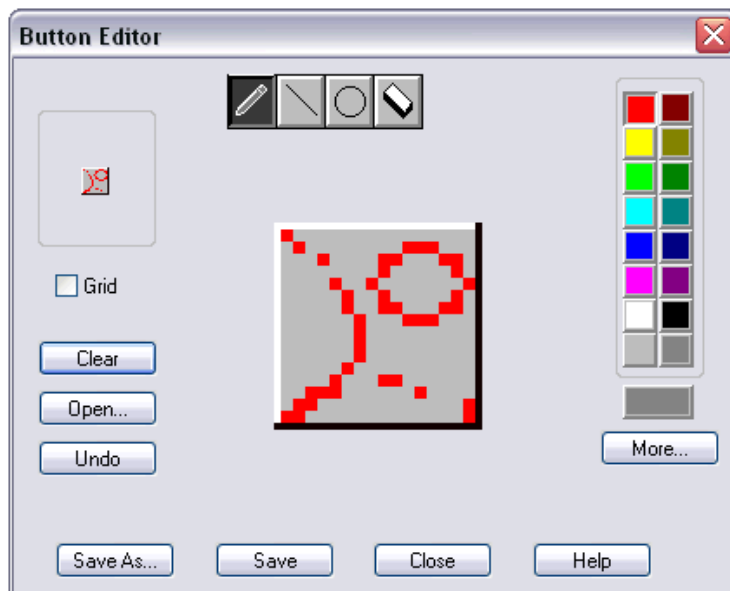

10. **Close** the button properties window by selecting the X in the upper right corner.
11. **Close** the Toolbars window.

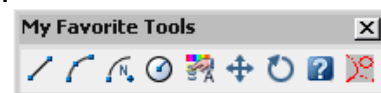

AutoCAD 2D Tutorial

Macros 36.6

1. **Click** Your right mouse button on the button you wish to modify or create.
2. **Type** the macro command in the macro window.

Macro that inserts a block called chair

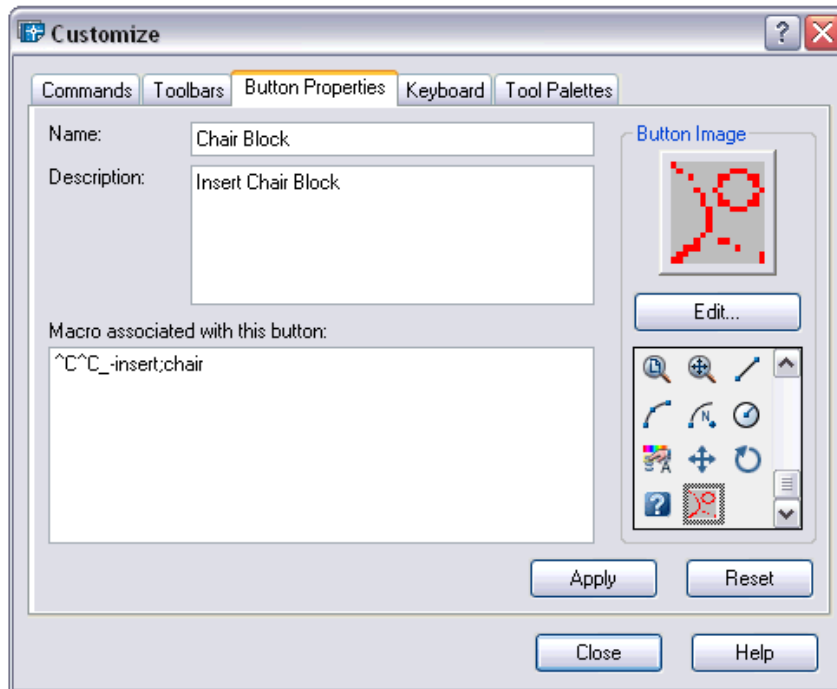

TIPS:

- Use ^C^C to cancel any previous AutoCAD command
- apostrophe (') will issue a transparent command
- Use a semicolon (;) to separate a series of commands
- a dash (-) will issue the command without a dialog box.

AutoCAD 2D Tutorial

Characters Used in Macros 36.7

Pausing for User Input Example

To accept input from the keyboard or the pointing device in the middle of a menu macro, place a backslash (\) at the point where you want input.

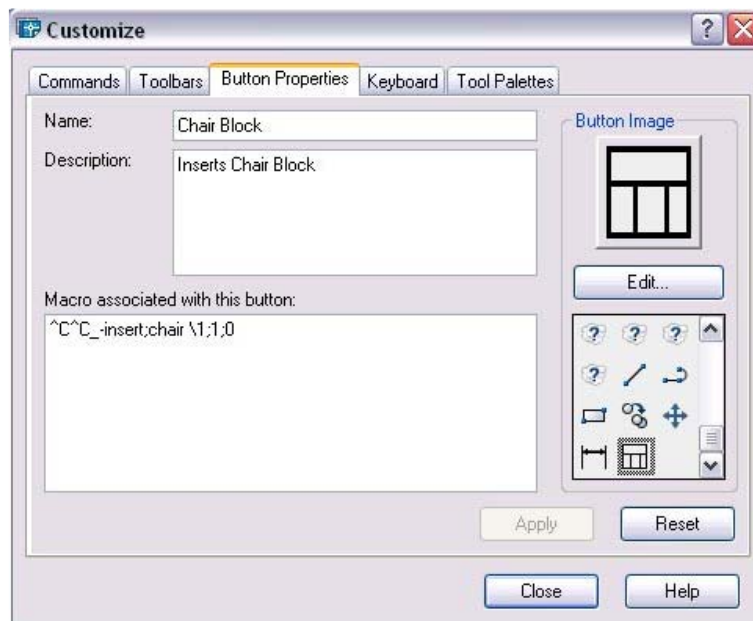

;	Issues ENTER
^M	Issues ENTER
^I	Issues TAB
SPACEBAR	Enters a space; blank space between command sequences in a menu item is equivalent to pressing the SPACEBAR
\	Pauses for user input (cannot be used in the erators section)
Accel	
_	Translates AutoCAD commands and keywords
that	follow
+	Continues menu macro to the next line (if last character)

AutoCAD 2D Tutorial

=*	Displays the current top level image, pull-down, or shortcut menu
*^C^C	Prefix for a repeating item
\$ or expression	Special character code that loads a menu section introduces a conditional DIESEL macro
	(\$M=)
^B	Toggles Snap on or off (CTRL+B)
^C	Cancels command (ESC)
^D the	Toggles Coords on or off (CTRL+D) SPACEBAR at end of a menu item
^E	Sets the next isometric plane (CTRL+E)
^G	Toggles Grid on or off (CTRL+G)
^H	Issues backspace
^O	Toggles Ortho on or off (CTRL+O)
^P	Toggles MENU ECHO on or off
^Q	Echoes all prompts, status listings, and input to the printer (CTRL+Q)
^T	Toggles tablet on or off (CTRL+T)
^V	Changes current viewport (CTRL+V)
^Z of	Null character that suppresses the automatic addition

AutoCAD 2D Tutorial

Editing Menus in Word 36.8

1. **Open** a menu (.mnu) file in a text editor.
2. **Change** the desired menu.
3. **Type** MENU at the AutoCAD command prompt to compile and use the menu in AutoCAD/

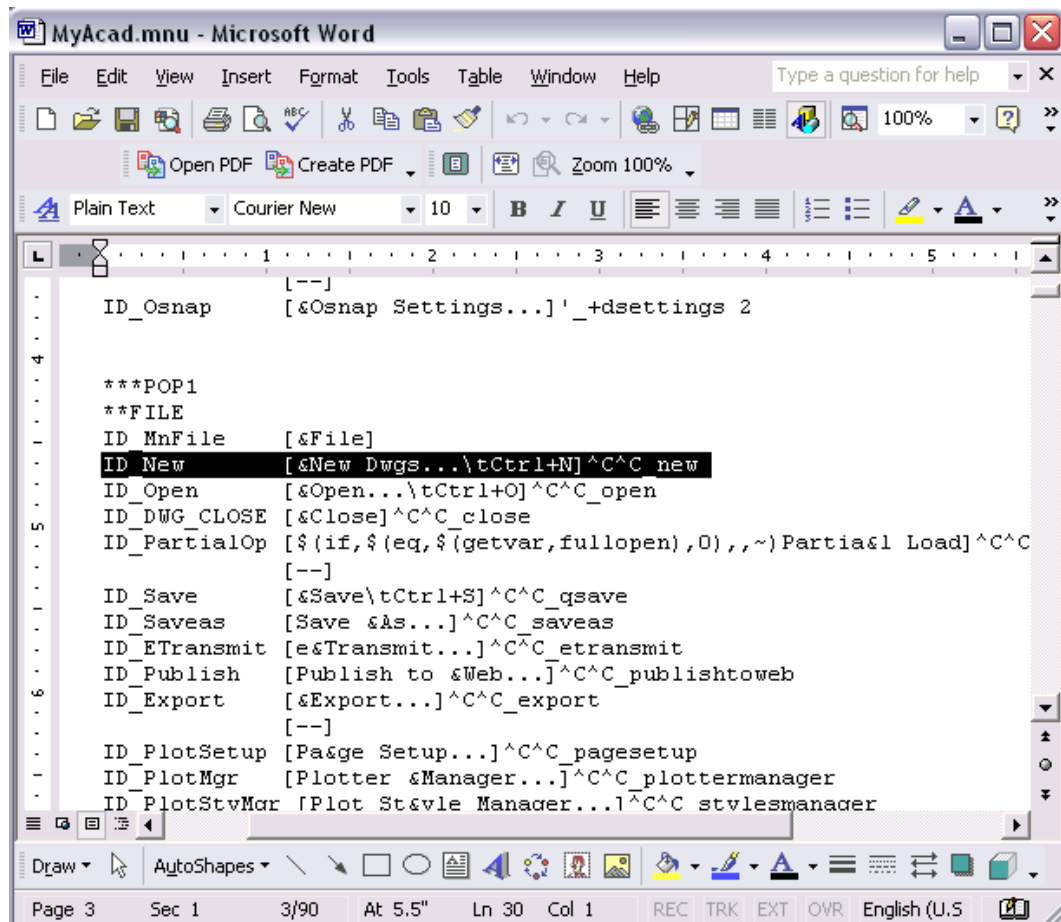

Chapter 38 **Slide Shows**

AutoCAD 2D Tutorial

Creating Slides 38.1

MSlide Command

1. **Type** MSLIDE at the command prompt.
Command: **MSLIDE**
2. **Type** the name of the slide file (and location).

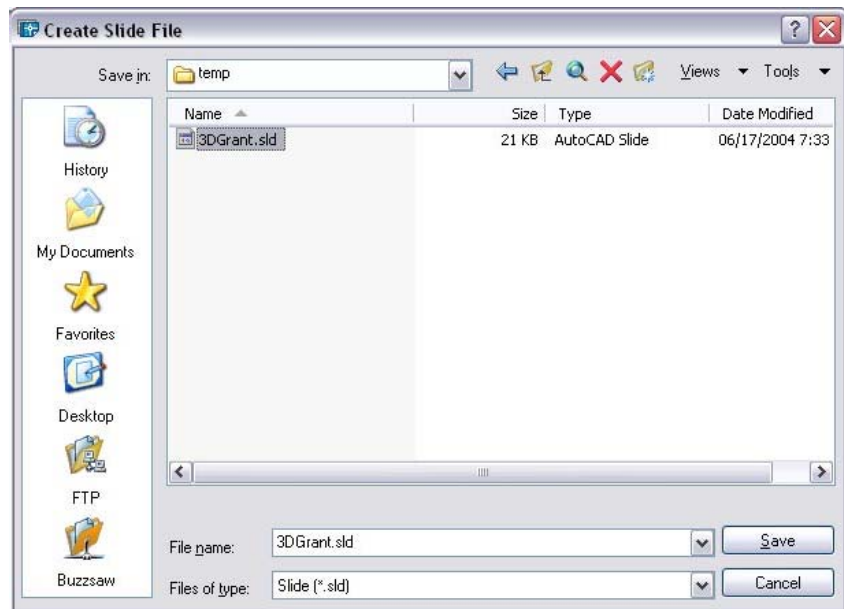

AutoCAD 2D Tutorial

Viewing Slides 38.2

1. **Type** VSLIDE at the command prompt.
Command: **VSLIDE**
2. **Pick** the name of the slide file (and location).

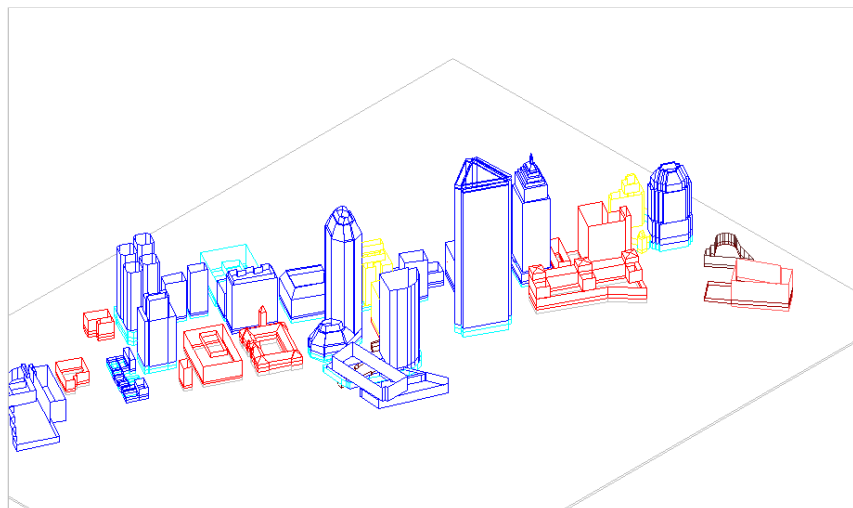
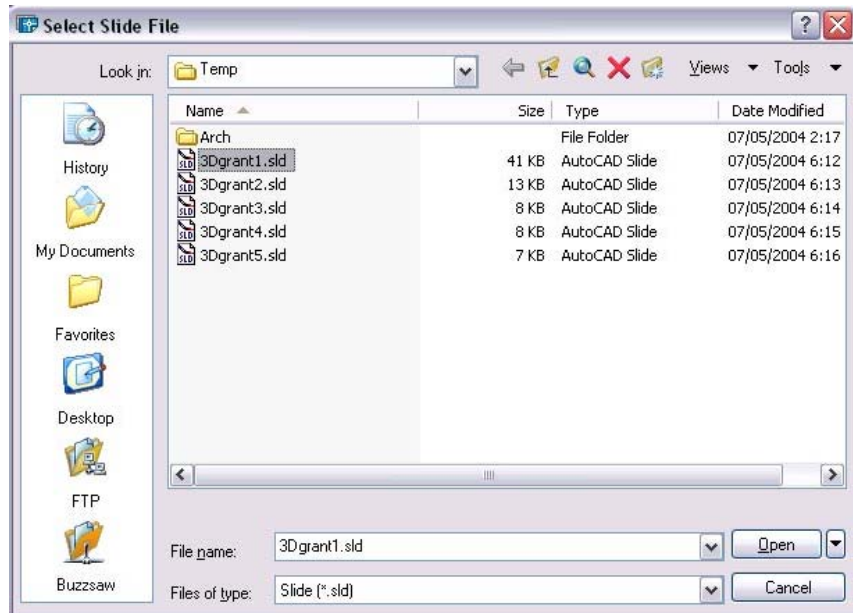

AutoCAD 2D Tutorial

Slideshows 38.3

Scripts

In a Word Processor, create a series of commands to execute in AutoCAD.

Save the script file with an extension called **.SCR**.

Pausing a Slide

1. **Type** DELAY at the command prompt.
Command: **DELAY**

Enter delay time (in milliseconds): **3000**

NOTE: 3000 milliseconds is 3 seconds

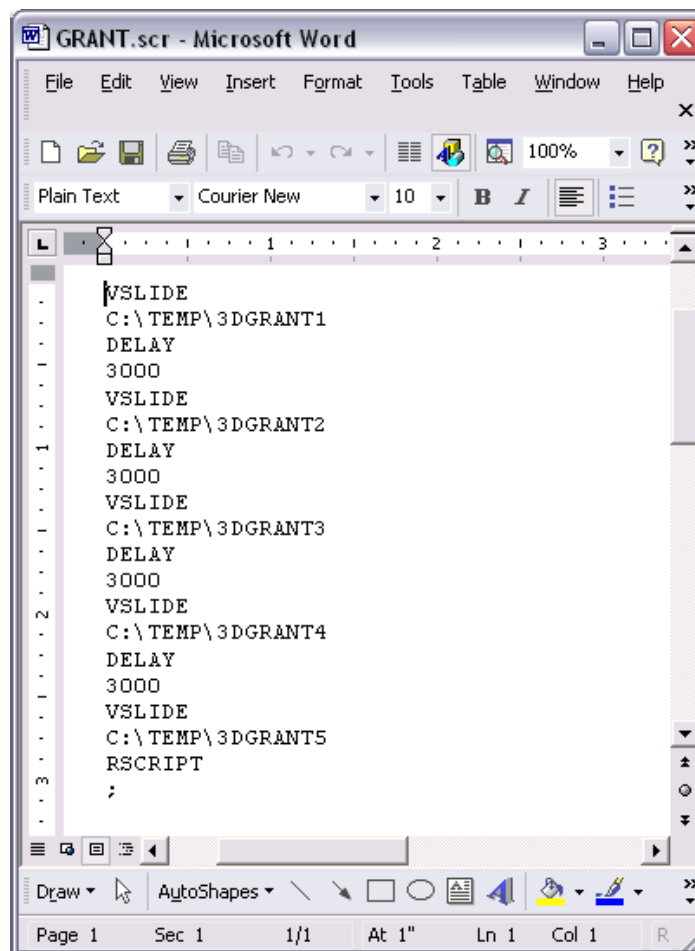

AutoCAD 2D Tutorial

Running a Script in AutoCAD

1. **Type** SCRIPT at the command prompt.
Command: **SCRIPT**
2. **Pick** the script name to run.

Repeating a Script

1. **Type** RSCRIPT at the command prompt.
Command: **RSCRIPT**
This will repeat the script command lines continuously.

Chapter 39 CAD Standards

AutoCAD 2D Tutorial

39.1 Drawing Standards (.DWS) Files

Standards define a set of common properties for named objects such as layers and text styles. You or your CAD manager can create, apply, and audit standards in AutoCAD drawings to enforce consistency. Because standards make it easier for others to interpret drawings, standards are particularly useful in collaborative environments, where many individuals contribute to the standards.

1. **Open** a drawing with standards defined (i.e. AIALayersSampleDrawing.dwg)
2. **Type** SAVEAS at the command prompt.
Command: **saveas**
3. **Choose** .DWS as the file type to save.
4. **Save** the drawing standard file.

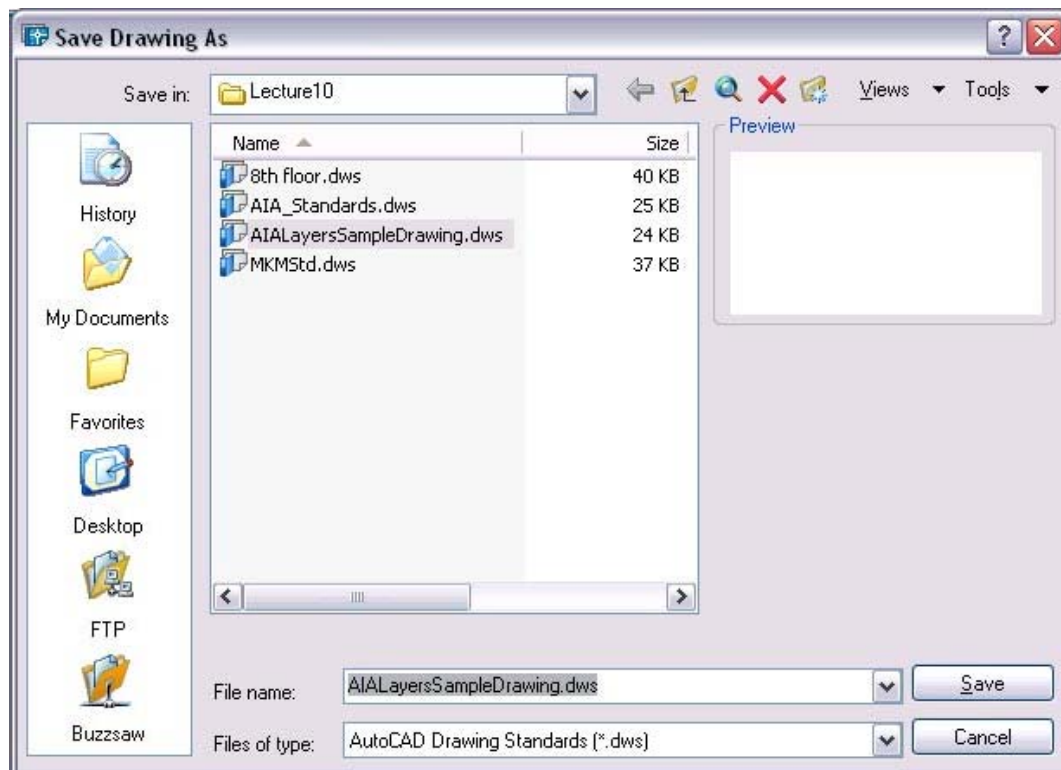

AutoCAD 2D Tutorial

39.2 CAD Standards Manager

1. **Choose** Tools, CAD Standards, Configure... or
2. **Type** STANDARDS at the command prompt.
Command: **standards**
3. **Choose** Add standards button to add a standards file (aialayer.dws)

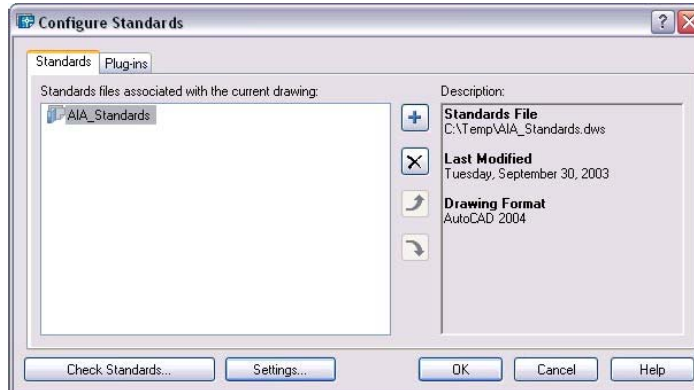

4. **Open** a drawing to check its standards (i.e. HBH-G.dwg)
5. **Load** the CAD standards AIALayer.DWS file.
6. **Choose** Checkstandads... or
7. **Type** CHECKSTANDARDS at the command prompt.
Command: checkstandards
8. **Choose** the fix button to make changes to the existing drawing.

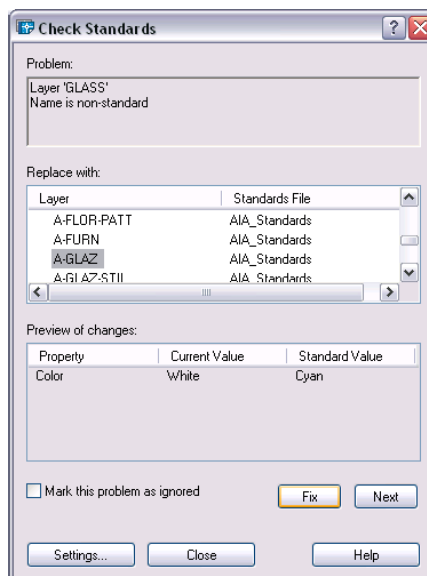

AutoCAD 2D Tutorial

39.3 Layer Translator

1. **Type** LAYTRANS at the command prompt.
Command: **laytrans**
or
2. **Choose** Tools, CAD Standards, Layer Translator.
3. **Choose** Load...to load standards from a .DWS or .DWG file.
4. **Match** the layers in the current drawing to the layers in the .DWG or .DWS file.

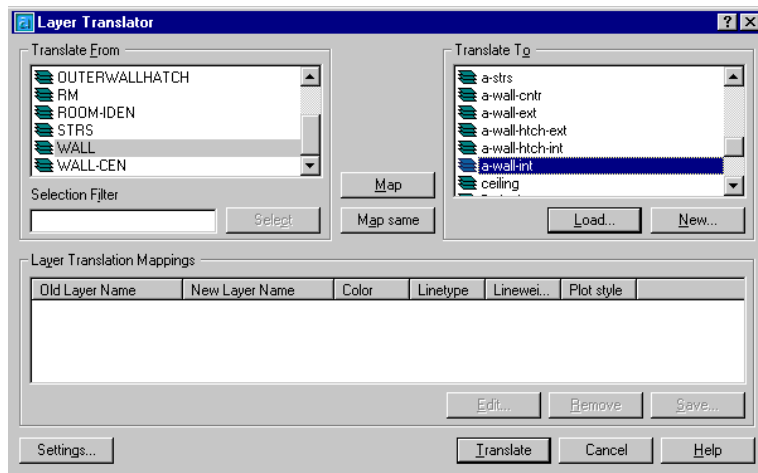

AutoCAD 2D Tutorial

39.4 Batch Standards Checker

Performs batch checking on multiple drawings outside of AutoCAD's drawing editor.

1. **Choose** Start, Programs, AutoCAD 2000x, Batch Standards Checker.
2. **Load** multiple drawings to check.

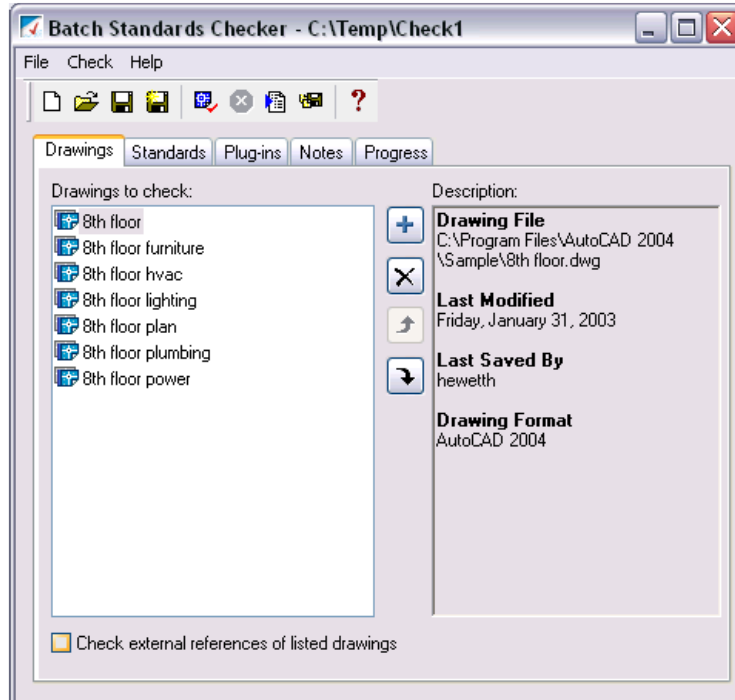

3. **Compare** to an existing standards file (i.e. aialayers.dws).

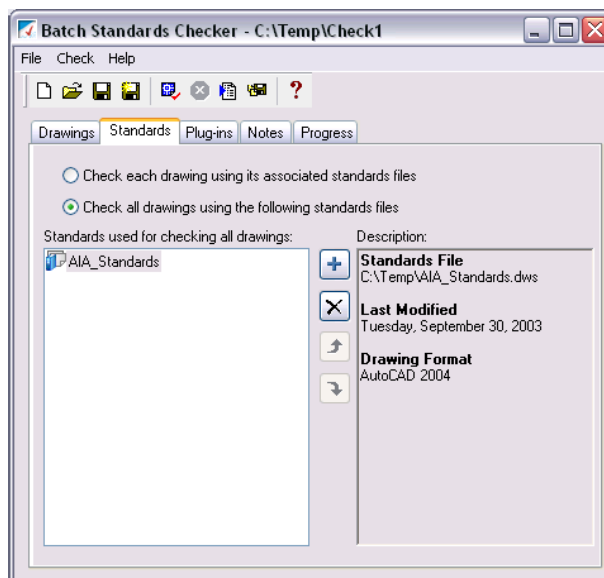

AutoCAD 2D Tutorial

4. **Save** the standards audit as a file (.chx)

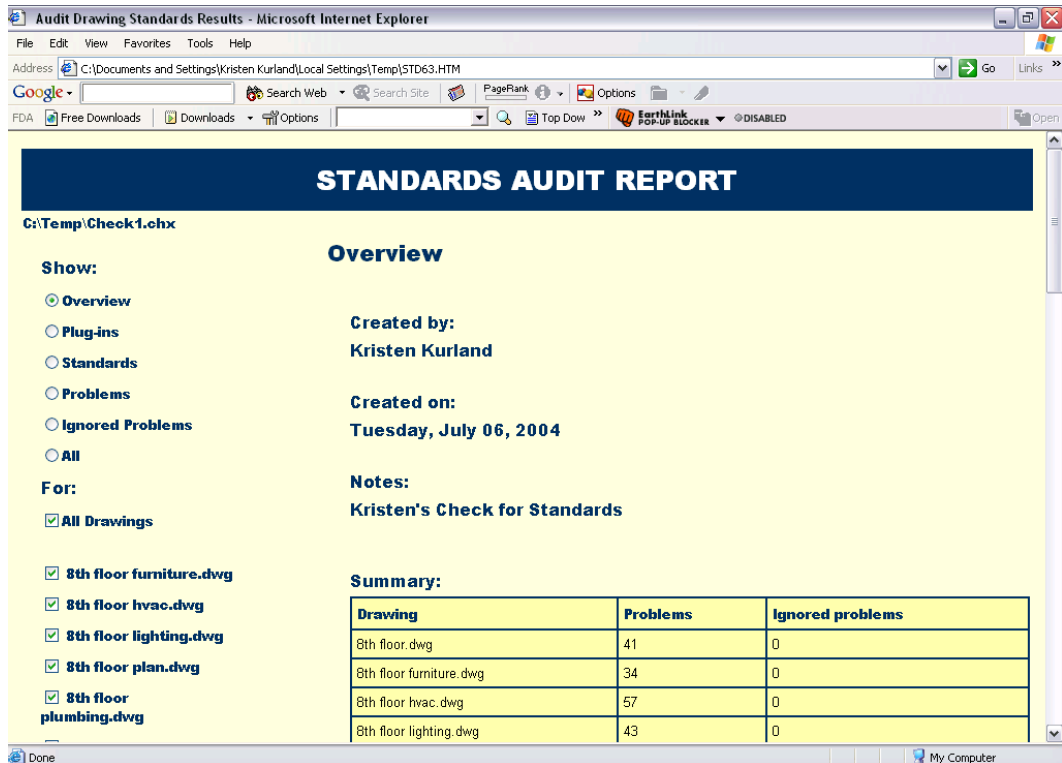
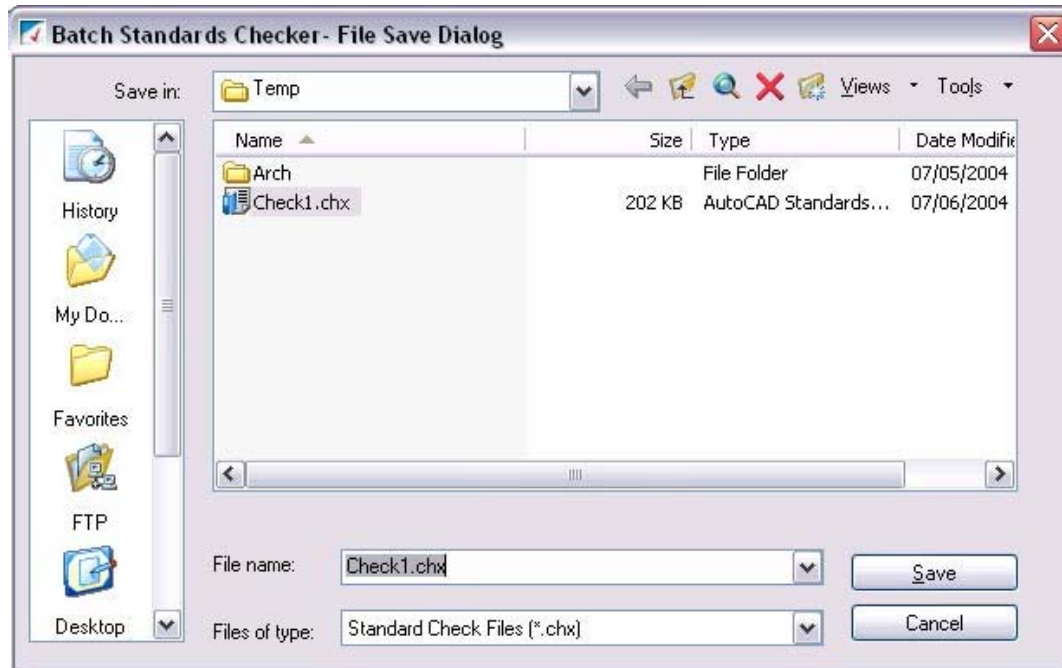

AutoCAD 2D Tutorial

39.5 Redline Markup Language

1. **Choose** Insert, Markup...
2. **Pick** a markup language file to insert.

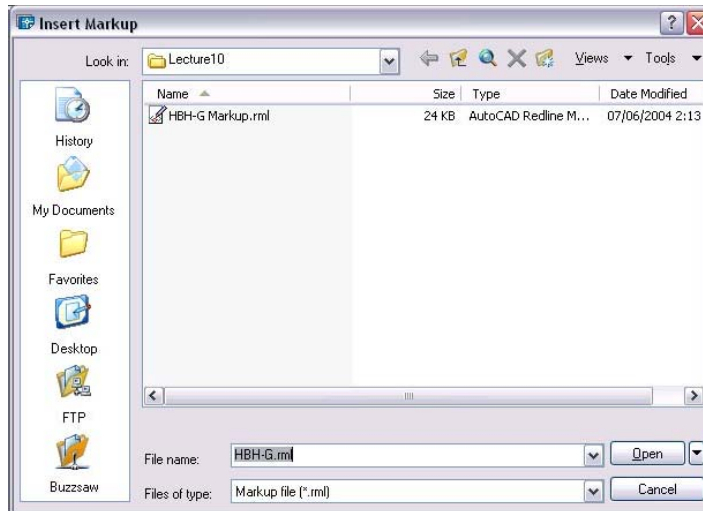

TIPS:

Markups range from hyperlinks to simple boxes and circles. Created in programs such as VoloView

A new "MARKUP" layer is created in the current drawing.

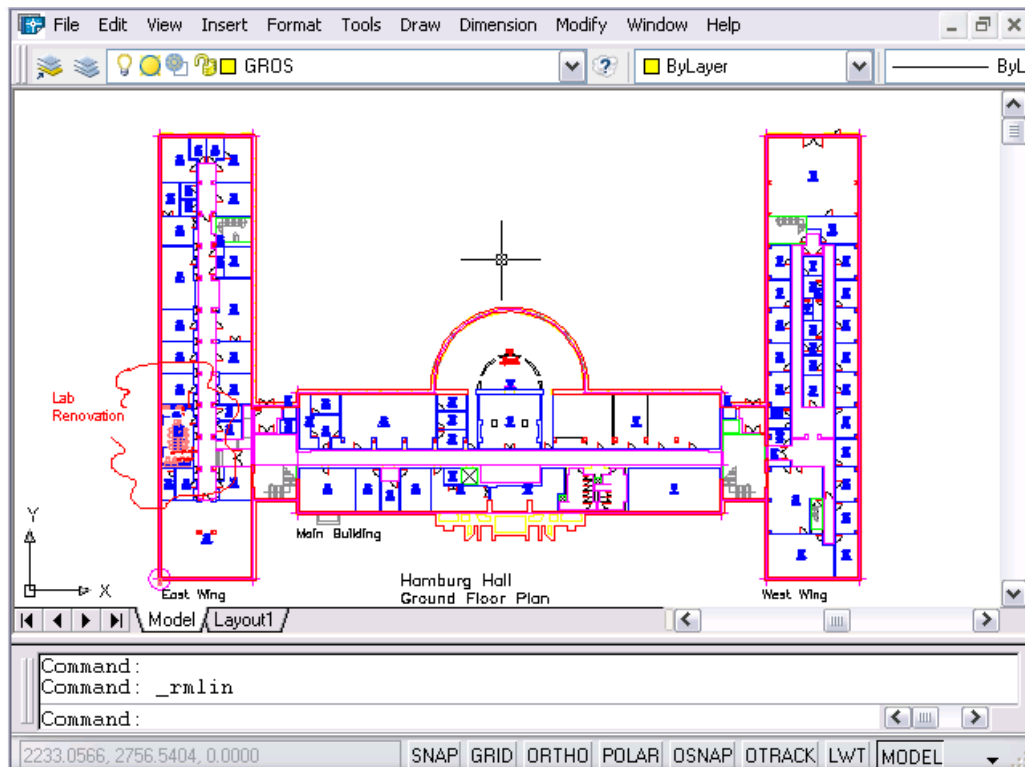

39.6 Revision Cloud

1. **Choose** Draw, Revcloud
or
2. **Type** **REVCLOUD** at the command prompt.
Command: **revcloud**
Minimum arc length: 0.5000
Maximum arc length: 0.5000
Specify start point or [Arc length/Object]
<Object>: Guide crosshairs along cloud path...
Revision cloud finished.
or
3. **Click** the Revcloud icon from the draw menu. 

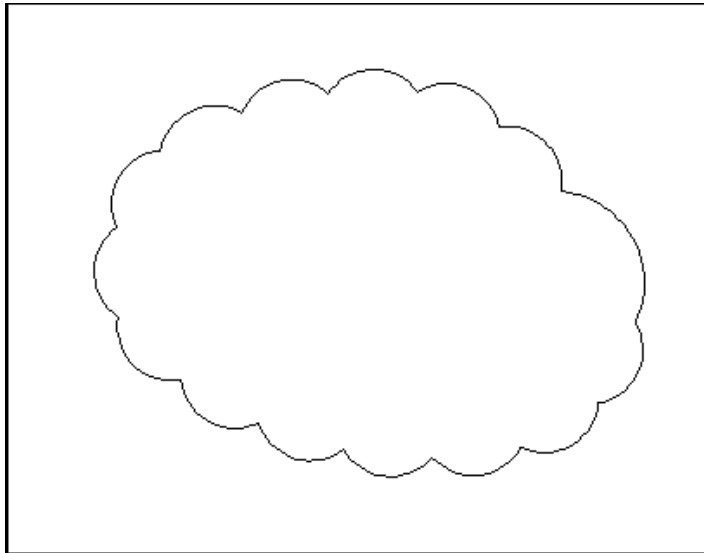

AutoCAD 2D Tutorial

39.8 Wipeout

Creates a polygonal area that masks underlying objects with the current background color. This area is bounded by the wipeout frame. You can turn on the wipeout frame for editing and turn it off for plotting.

1. **Choose** Draw, Wipeout
or
2. **Type** WIPEOUT at the command prompt.
Command: **_wipeout**
Specify first point or [Frames/Polyline] <Polyline>:
Select a closed polyline:

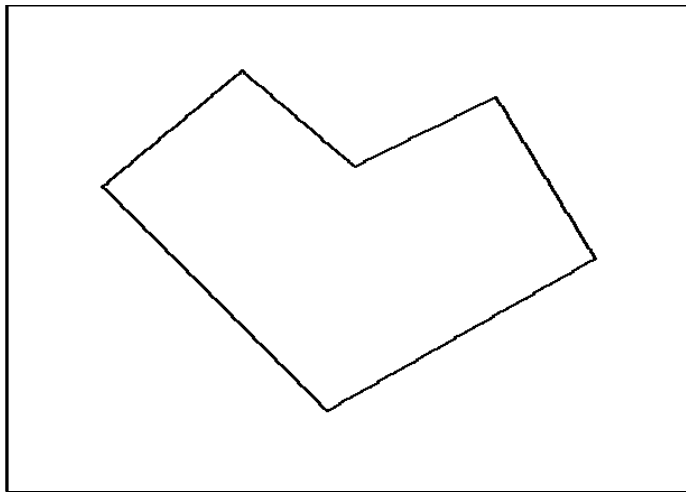

Chapter 40 Isometrics

AutoCAD 2D Tutorial

Isometric Cursor 40.1

1. **Choose** Tools, Drawing Aids...
or
2. **Type** DDRMODES at the command prompt.
Command: **DDRMODES**
3. **Toggle** Isometric Snap/Grid to ON.

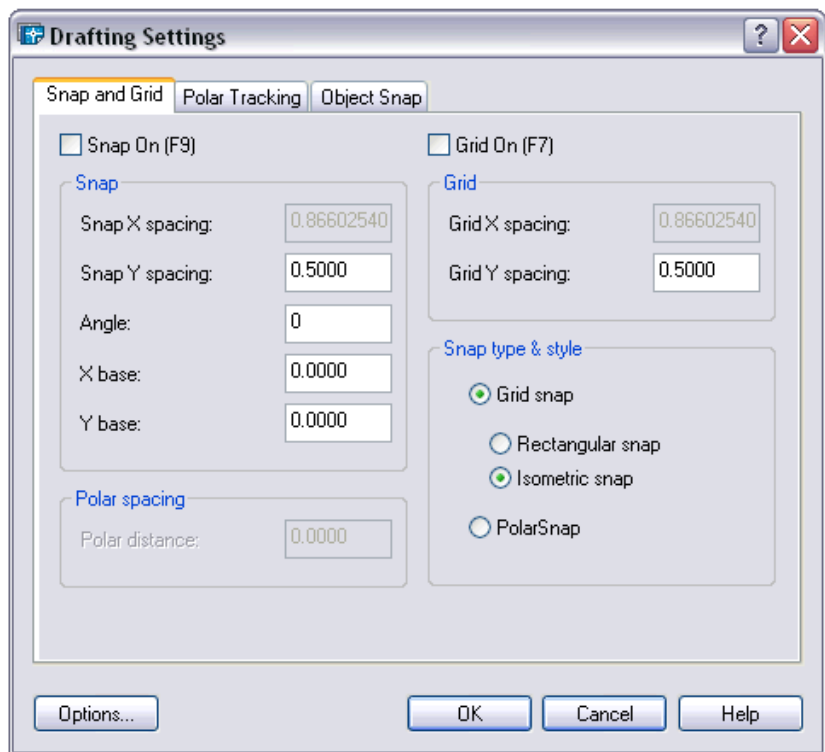

AutoCAD 2D Tutorial

Isoplane Toggle 40.2

1. **Press** Function Key F5 to toggle
<Isoplane Top>
<Isoplane Left>
<Isoplane Right>
or
2. **Press** **CTRL + E** to toggle isoplanes.

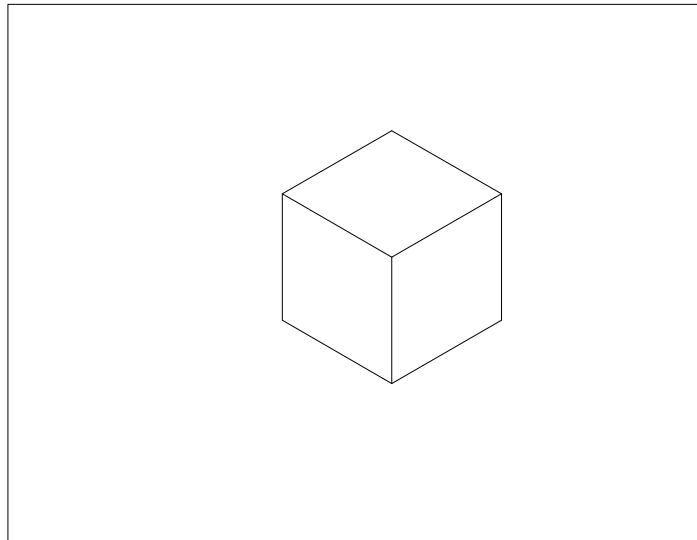

AutoCAD 2D Tutorial

Isometric Circles 40.3

1. **Type** ELLIPSE at the command prompt.
 Command: **ELLIPSE** or **EL**
 Arc/Center/Isocircle/<Axis endpoint 1>: | Center
 of circle: <Isoplane Top>
 <Circle radius>/Diameter:

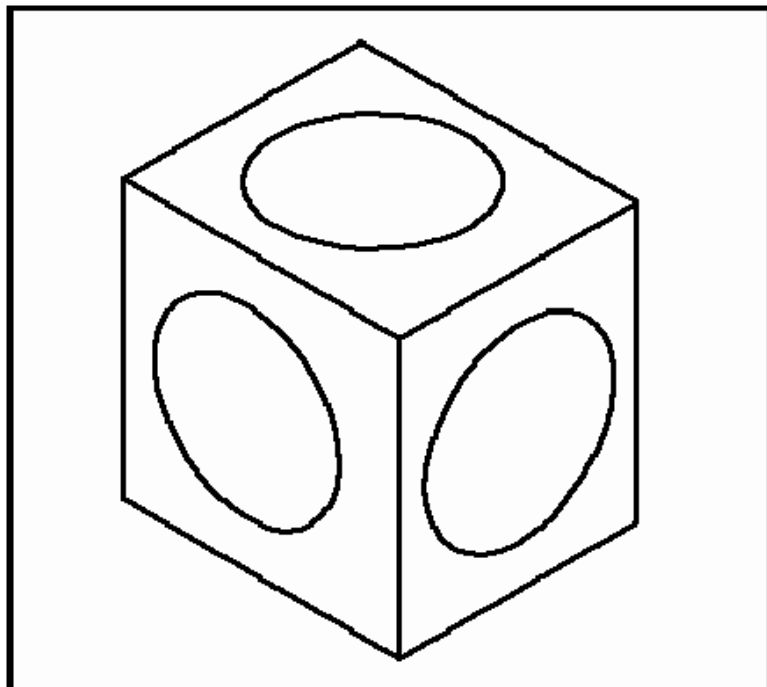

AutoCAD 2D Tutorial

Isometric Text 40.4

1. **Type** STYLE at the command prompt
Command:**STYLE**
2. **Type** RISO as a style name
Text style name (or ?) **RISO**
3. **Pick** A font file
Font file: **Romans.shx**
4. **Type** Zero(0) for the text height
Height <0>**0**
5. **Type** .85 for the character width factor
Width factor: **.85**
6. **Type** 30 degrees for an obliquing angle
Obliquing Angle: **30**
7. **Type** NO to Backwards, Upside Down, and Vertical
8. **Type** DTEXT at the command prompt
Command:**DTEXT**
9. **Pick** A start point
Justify/Style/<Start point>: **pick**
10. **Type** 30 for the rotation angle
Rotation angle:30
11. **Type** A string of text
Text:(text string)
12. **Press** ENTER to end the text command

AutoCAD 2D Tutorial

Style	Width Factor	Oblique Angle	Rotation Angle
Left ISO	.85	-30	-30
Right ISO	.85	30	30
Top ISO	.85	30	-30

AutoCAD 2D Tutorial

Isometric Dimensions 40.5

1. **Type** DIMALIGNED to place an aligned dimension in isometrics
2. **Type** DIMEDIT oblique the angle of the dimension line and rotate the text.
Oblique Angle = **-30**
Rotated Text = **30**

